

High voltage BST capacitance controller

Datasheet – production data

Features

- Dedicated ASIC to control BST tunable capacitances
- Operation compliant with cellular systems requirements
- Integrated boost converter with 3 programmable outputs (from 0 to 30 V)
- Low power consumption
- 3-wire serial interface (30 or 32 bit SPI)
- Available in WLCSP for stand-alone or SiP module integration
- RF tunable passive implementation in mobile phones to optimize the radiated performances

Application

- Cellular antenna tunable matching network in multi-band GSM/WCDMA mobile phone
- Compatible with open loop antenna tuner applications

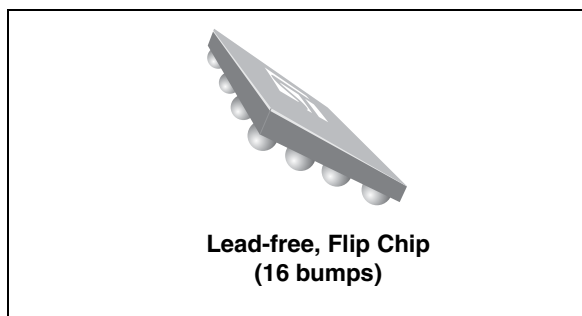
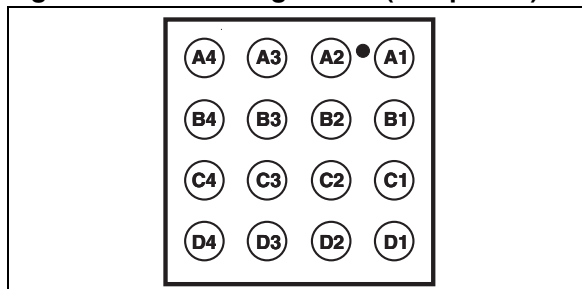

Figure 1. Pin configuration (bump view)



Description

The ST BST capacitance controller STHVDAC-303 is a high voltage digital to analog converter (DAC), specifically designed to control and meet the wide tuning bias voltage requirement of the BST tunable capacitances.

It provides 3 independent high voltage outputs, thus having the capability to control 3 different capacitances in parallel. It is fully controlled through a 3-wire serial interface.

BST capacitances are tunable capacitances intended for use in mobile phone application, and dedicated to RF tunable applications. These tunable capacitances are controlled through a bias voltage ranging from 0 to 30 V. The implementation of BST tunable capacitance in mobile phones enables significant improvement in terms of radiated performance, making the performance almost insensitive to the external environment.

Contents

1	Electrical characteristics	3
2	Functional block diagram	7
3	Theory of operation	8
	3.1 HVDAC output voltages	8
	3.2 Operating modes	9
	3.3 Power-on reset	9
	3.4 3-wire serial interface	9
	3.5 Power-up / down sequence	9
	3.6 Settling time	9
	3.7 Power supply sequencing	10
	3.8 Timing parameters	11
4	Register table	12
5	Serial interface specification	13
6	Serial interface frame structure	15
7	Application schematic	18
8	Ordering information schemes	20
9	Package information	21
10	Ordering information	22
11	Revision history	23

1 Electrical characteristics

Table 1. Absolute maximum ratings (limiting value)

Symbol	Parameter	Rating	Unit
V_{DD}	Analog supply voltage	-0.3 to +5.5	V
V_{dig}	Digital supply voltage	-0.3 to +3.3	V
$V_{I/O}$	Input voltage logic lines (DATA, CLK, CS)	-0.5 to $V_{dig} + 0.5$	V
$V_{ESD (HBM)}$	Human body model, JESD22-A114-B, All I/O	2	kV
$V_{ESD (CDM)}$	Charge device model, JESD22-C101-C, All I/O	500	V
T_{stg}	Storage temperature range	-55 to +150	°C
T_j	Maximum junction temperature	150	°C

Table 2. Recommended operating conditions

Symbol	Parameter	Rating			Unit
		Min.	Typ.	Max.	
T_{AMB_oP}	Operating ambient temperature	-25	-	+85	°C
V_{DD}	Analog supply voltage	2.3	-	5	V
V_{dig}	Digital supply voltage	1.7	-	3	V
V_{IH}	Input voltage logic level HIGH (DATA, CLK, CS)	$0.7 \cdot V_{dig}$	-	$V_{dig} + 0.3$	V
V_{IL}	Input voltage logic level LOW (DATA, CLK, CS)	-0.3	-	$0.35 \cdot V_{dig}$	V

Table 3. DC characteristics

Conditions: AV _{DD} from 2.3 to 5 V, V _{dig} from 1.7 to 3 V, T _{amb} from -25 °C to +85 °C unless otherwise specified						
Symbol	Parameter	Conditions	Min.	Typ. ⁽¹⁾	Max.	Unit
I _{DD}	AV _{DD} supply current	Shutdown mode			5	μA
		Active mode (3 outputs active)		0.67	1	mA
I _{dig}	V _{dig} supply current	Shutdown mode, CS level LOW			10	μA
		Active Mode: (3 outputs active) CS LOW			0.2	mA
		CS HIGH, F _{CLK} = 13 MHz CS HIGH, F _{CLK} = 26 MHz			0.6 1	
I _{IH}	Input current logic level HIGH	Any mode, DATA, CLK, CS pins	-2		2	μA
I _{IL}	Input current logic level LOW	Any mode, DATA, CLK, CS pins	-2		2	μA

1. Typical value with typical application condition, V_{HV} = 20 V, AV_{DD} = 3.3 V, 25 °C, I_{load} = 3*1μA

Table 4. Boost converter characteristics

Conditions: AV _{DD} from 2.3 to 5 V, V _{dig} from 1.7 to 3 V, T _{amb} from -25 °C to +85 °C unless otherwise specified)						
Symbol	Parameter	Conditions	Min.	Typ.	Max.	Unit
V _{hv_low}	Minimum programmable output voltage	Active mode, DAC_boost = 0h		15		V
V _{hv_high}	Maximum programmable output voltage	Active mode, DAC_boost = Fh		30		V
Resolution	Boost voltage resolution	4 bits DAC		1		V
Error	DAC boost error	DAC A, DAC B, DAC C and DAC_boost settings according to Table 6 .	-6		+6	%V _{out}

Table 5. High voltage DAC output characteristics

Conditions: AV _{DD} from 2.3 to 5 V, V _{dig} from 1.7 to 3 V, T _{amb} from -25 °C to +85 °C, OUTA, OUTB, OUTC, unless otherwise specified)						
Symbol	Parameter	Conditions	Min.	Typ.	Max.	Unit
SHUTDOWN MODE						
Z _{out}	OUTA, OUTB, OUTC output impedance		7			MΩ
ACTIVE MODE						
V _{OH}	OUTA, OUTB, OUTC maximum output voltage	DAC A = DAC B = DAC C = FFh DAC_boost = Fh, I _{OH} < 10 μA	26.5			V
V _{OL}	OUTA, OUTB, OUTC minimum output voltage	DAC A = DAC B = DAC C = 01h DAC_boost from 0h to Fh I _{OL} < 10 μA			2	V
R _{PD}	OUTA, OUTB, OUTC set in pull down mode	DAC A = DAC B = DAC C = 00h DAC_boost from 0h to Fh			500	Ω
Resolution	Voltage resolution / OUTA, OUTB, OUTC	8 bits DAC, full range 30 V		117.64		mV
V _{offset}	Zero scale offset	DAC A, DAC B, DAC C and DAC_boost settings according to Table 6 .	-2		+2	LSB
INL	Integral non linearity	DAC A, DAC B, DAC C and DAC_boost settings according to Table 6 .	-3		+3	LSB
DNL	Differential non linearity	DAC A, DAC B, DAC C and DAC_boost settings according to Table 6 .	-0.5		+0.5	LSB
Δgain	Gain error	DAC A, DAC B, DAC C and DAC_boost settings according to Table 6 .	-6		+6	%V _{out}
I _{sc}	Over current protection	Any DAC output			50	mA

Table 6. Recommended settings for DAC outputs and DAC_boost

Conditions: AV _{DD} from 2.3 to 5 V, V _{dig} from 1.7 to 3 V, T _{amb} from -25 °C to +85 °C, OUTA, OUTB, OUTC, unless otherwise specified						
Symbol	Parameter	Conditions	Min.	Typ.	Max.	Unit
DAC _{MIN}	Minimum DAC setting	DAC_boost from 0h to Fh	13h			-
DAC _{MAX}	Maximum DAC setting	DAC_boost = 0h DAC_boost = 1h DAC_boost = 2h DAC_boost = 3h DAC_boost = 4h DAC_boost = 5h DAC_boost = 6h DAC_boost = 7h DAC_boost = 8h DAC_boost = 9h DAC_boost = Ah DAC_boost = Bh DAC_boost = Ch DAC_boost = Dh DAC_boost = Eh DAC_boost = Fh			5Dh 65h 6Dh 75h 7Dh 85h 8Dh 95h 9Dh A5h ADh B5h BDh C5h CDh D5h	-
VDAC _{typ}	Typical DAC output voltage	DAC_boost = 0h, DACx = DAC _{MAX} DAC_boost = 1h, DACx = DAC _{MAX} DAC_boost = 2h, DACx = DAC _{MAX} DAC_boost = 3h, DACx = DAC _{MAX} DAC_boost = 4h, DACx = DAC _{MAX} DAC_boost = 5h, DACx = DAC _{MAX} DAC_boost = 6h, DACx = DAC _{MAX} DAC_boost = 7h, DACx = DAC _{MAX} DAC_boost = 8h, DACx = DAC _{MAX} DAC_boost = 9h, DACx = DAC _{MAX} DAC_boost = Ah, DACx = DAC _{MAX} DAC_boost = Bh, DACx = DAC _{MAX} DAC_boost = Ch, DACx = DAC _{MAX} DAC_boost = Dh, DACx = DAC _{MAX} DAC_boost = Eh, DACx = DAC _{MAX} DAC_boost = Fh, DACx = DAC _{MAX}		10.90 11.84 12.77 13.71 14.65 15.59 16.52 17.46 18.40 19.34 20.27 21.21 22.15 23.09 24.02 24.96		V

2 Functional block diagram

Figure 2. HVDAC functional block diagram

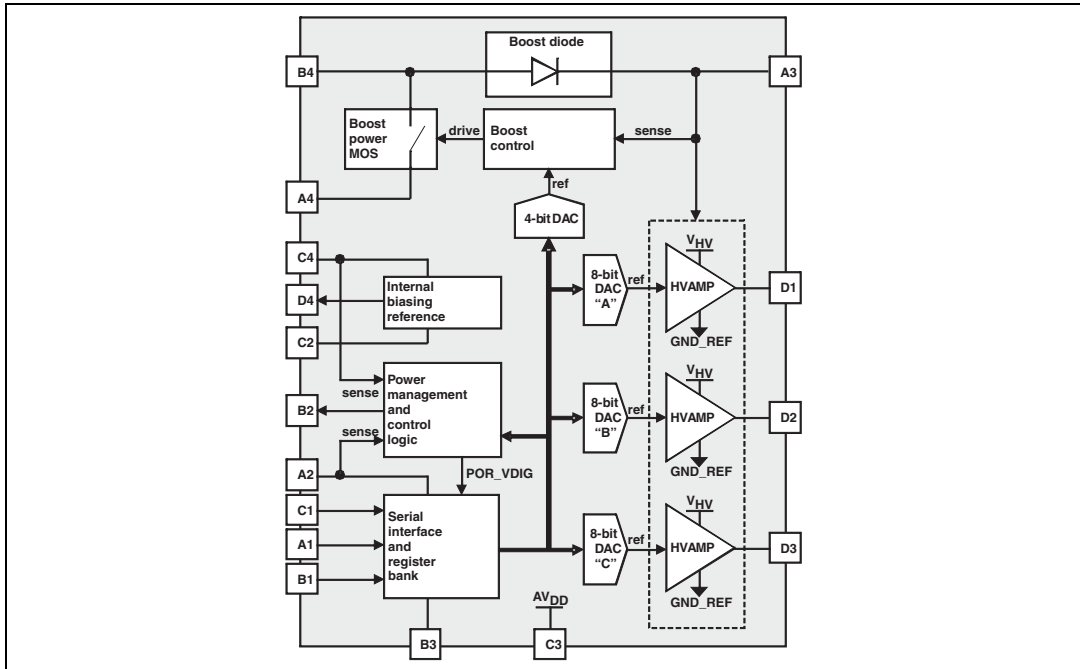

Table 7. Signal descriptions

Pin number	Pin name	Description
A1	DATA	Serial interface / Serial DATA
A2	V _{dig}	Digital supply
A3	VHV	Boost high voltage output
A4	GND_BOOST	Ground
B1	CS	Serial interface / Chip select
B2	TEST	Test pin / connected to GND in final application
B3	GND_DIG	Ground
B4	IND_BOOST	Boost inductance
C1	CLK	Serial interface / Serial clock
C2	GND_REF	Analog ground
C3	AVDD	Analog supply
C4	AVDD	Analog supply
D1	OUTA	High voltage output A
D2	OUTB	High voltage output B
D3	OUTC	High voltage output C
D4	R _{bias}	Biasing reference resistance

3 Theory of operation

3.1 HVDAC output voltages

The HVDAC outputs are directly controlled by programming the 8-bit DAC (DAC A, DAC B and DAC C) through the 3-wire serial interface.

The DAC stages are driven from a reference voltage, generating an analog output voltage driving a high voltage amplifier supplied from the boost converter (see HVDAC block diagram - [Figure 2](#)).

The HVDAC output voltages are scaled from 0 to 30 V, with 255 steps of 117 mV ($30/255 = 0.11764$ V). The nominal HVDAC output can be approximated to $117 \text{ mV} \times (\text{DAC value})$.

For performance optimization, it is also possible to control the boost output voltage (VHV) from 15 V to 30 V, by programming the DAC_boost value (4 bits / 1 V step).

For proper operation, ST recommends the operation of the HVDAC outputs 2 V below the actual boost output voltage (VHV), to avoid clamping the HVDAC outputs to the boost output voltage.

Recommended settings for DAC A, DAC B and DAC C according to DAC_boost settings are described in [Table 6.](#), considering the overall HVDAC accuracy. These recommended settings are further described on [Figure 5](#)

Minimum HVDAC output voltage is also limited to 2 V, meaning minimum DAC command is equal to 19 (or 13h), independent of the DAC_boost setting.

DAC settings can be programmed outside this recommended operating range, but in this case the HVDAC performance (accuracy and noise) be outside the specified range.

If DAC value is set to 00 h, then the corresponding output is directly connected to GND through a pull-down resistor (500 Ω).

Figure 3. Recommended DAC commands versus DAC_boost setting

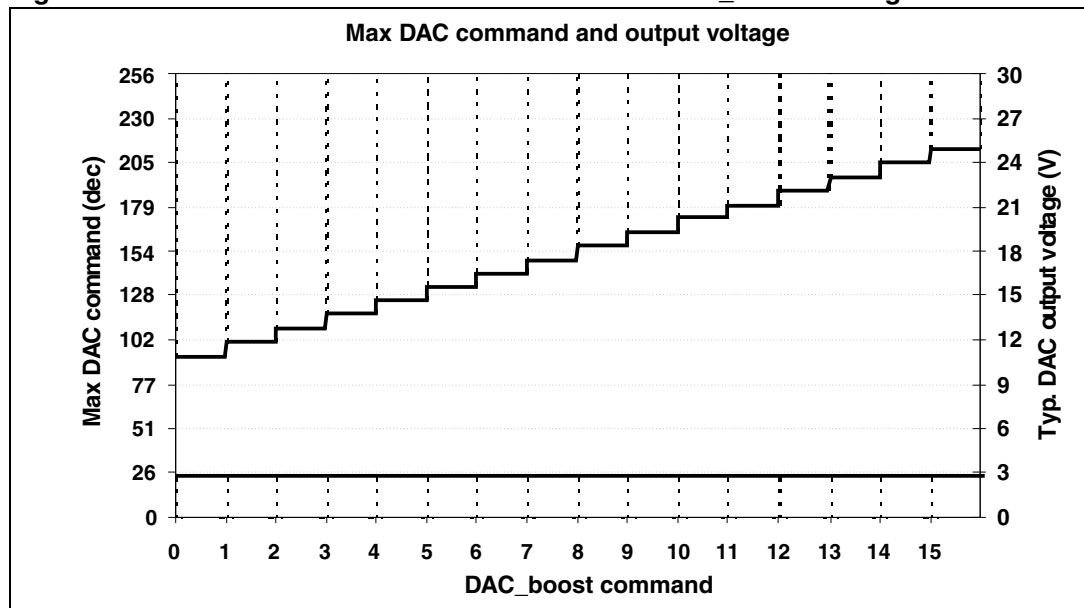

3.2 Operating modes

The following operating modes are accessible through the serial interface:

- **Shutdown mode:** The HVDAC is switched off, and all the blocks in the control ASIC are switched off. Power consumption is almost zero in this mode, the DAC outputs are in high Z state. The shutdown mode is set by sending a dedicated command through the serial interface.
- **Active mode:** The HVDAC is switched on and the DAC outputs are fully controlled through the serial interface. The DAC settings can be dynamically modified and the HV outputs will be adjusted according to the specified timing diagrams. Each DAC can be individually controlled and/or switched off according to application requirements. This mode is set and controlled through serial interface commands.

3.3 Power-on reset

Power-on reset is implemented on the V_{dig} supply input, ensuring the HVDAC will be reset to default mode once V_{dig} supply line rises above a given threshold (typically 1 V). This trigger will force all registers to their default value.

3.4 3-wire serial interface

The HVDAC is fully controlled through a 3-wire serial interface (DATA, CS, CLOCK). This interface is further described in the next sections of this document.

3.5 Power-up / down sequence

[Table 8](#) and [Figure 5](#) describe the HVDAC settling time requirements and recommended timing diagrams.

Switching from shutdown to active mode is triggered by sending a dedicated serial interface command.

Switching from active to shutdown mode will occur after sending the related command through the 3-wire serial interface.

Active mode can be directly activated from shutdown. In any case the HVDAC will be operational only after T_{active} (max 300 μs). A settling time (T_{set}) is required following each DAC command in active mode. During this settling time the HVDAC output voltages will vary from the initial to the updated DAC command.

3.6 Settling time

The ST HVDAC will set the bias voltage of the tuner within 35 μs after the chip select is released. The setting time is defined as the time it takes for the output to reach 95% of its final value. A positive setting time ($T_{\text{set}+}$) is defined when the output voltage rises and a negative setting time ($T_{\text{set}-}$) when it decreases to its final value. See [Figure 4](#) for details.

Figure 4. Bias voltage of the tuner

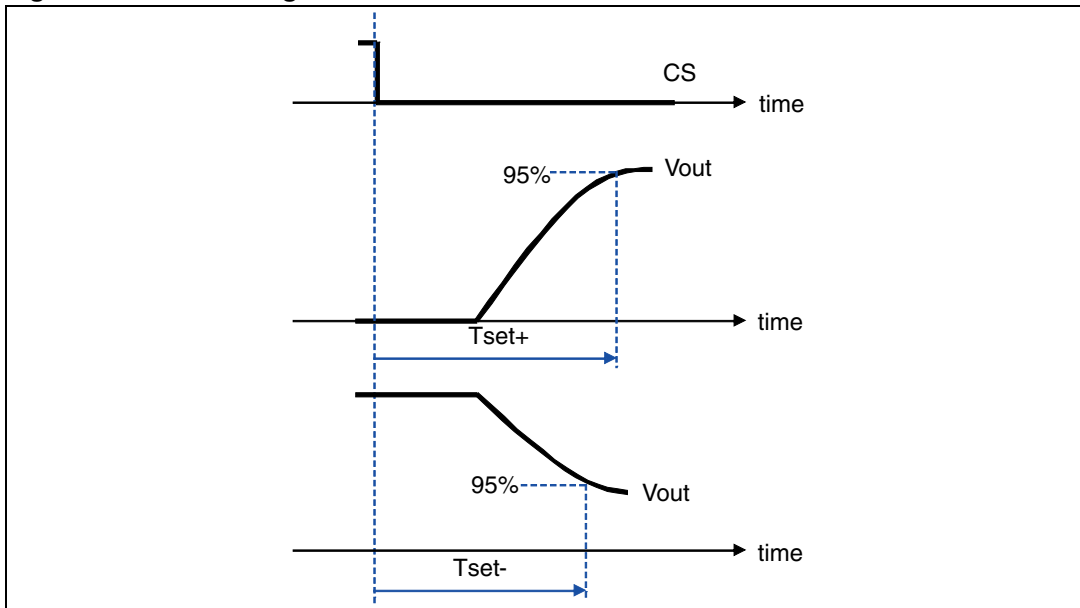

3.7 Power supply sequencing

The ST HVDAC does not require any specific power supply sequencing. It is assumed that the AV_{DD} input will be directly supplied from the battery and will then be the first on.

If V_{dig} supply is pulsed, 5 μs are required (max) to settle internal voltages before sending the first command through the 3-wire serial interface.

3.8 Timing parameters

Table 8. Timing parameters

Conditions: AV_{DD} from 2.3 to 5 V, V_{dig} from 1.7 to 3 V, T_{amb} from -25 °C to +85 °C, OUTA, OUTB, OUTC, unless otherwise specified				
Symbol	Parameter	Conditions	max.	Unit
T_{active}	Activation time	Internal voltages activation time from shutdown to active mode $C_{HV} = 22$ nF, DAC_boost = 07h	300	μ s
T_{set+}	Output positive setting time @ 95%	$C_{HV} = 22$ nF, DAC boost 07h, V_{out} 00h to 88h (worst-case), equivalent load of 15 k Ω and 1 nF	35	μ s
T_{set-}	Output negative setting time @ 95%	$C_{HV} = 22$ nF, DAC boost 07h, V_{out} 88 h to 13 h, equivalent load of 15 k Ω and 1 nF	35	μ s

Figure 5. Timing diagram example

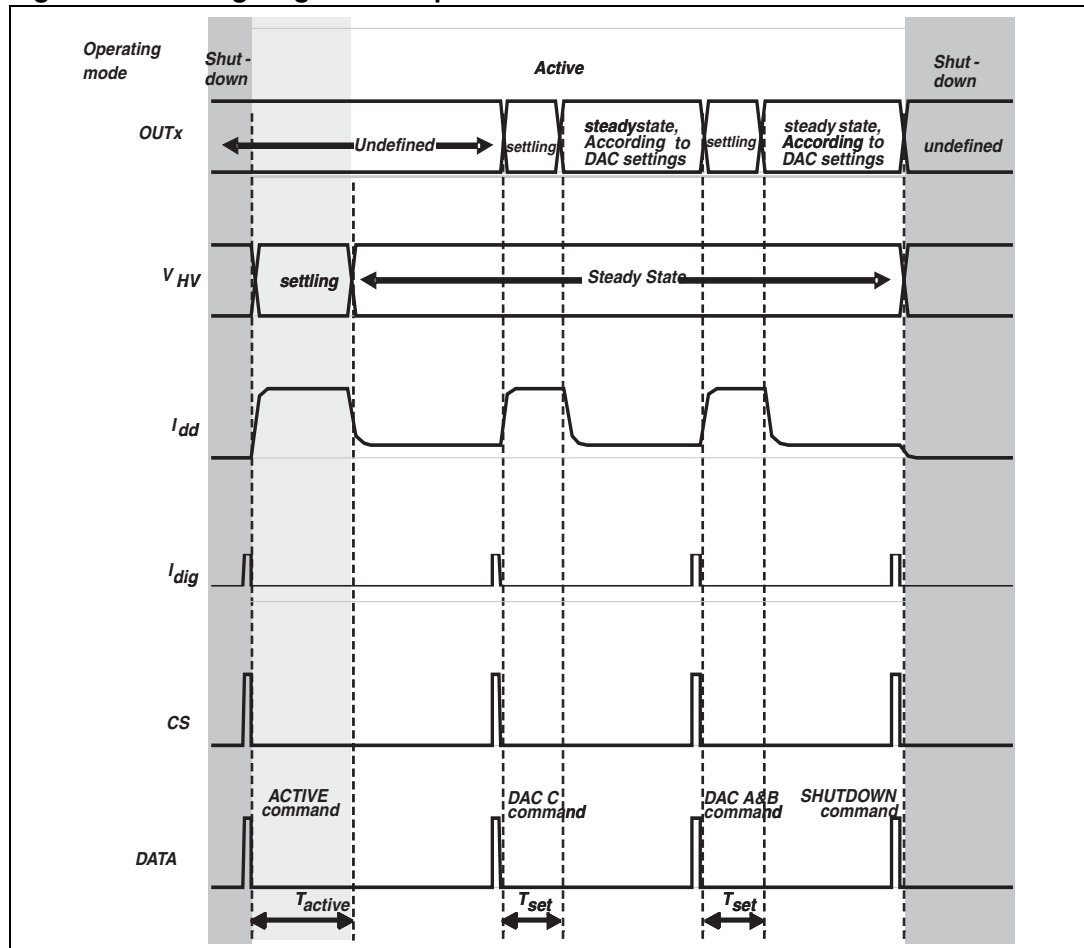

4 Register table

The HVDAC embeds 5 x 16-bit registers. Registers content is described in [Table 9](#).

Registers 1 to 3 are used to control the mode of operations and the HVDAC settings. HVDAC control and settings are thus fully ensured by programming these three registers.

Registers 4 and 5 are reserved for test purpose, and should not be addressed.

Table 9. Register table

Reg #	Name	Purpose	Access type	Size (bits)
1	DAC control DATA register #1	Used to set up OUT C	W	16
2	DAC control DATA register #2	Used to set up OUT A and B	W	16
3	DAC control Mode register	Used to set up the operating modes	W	16
4	Reserved			
5	Reserved			

5 Serial interface specification

Table 10. Interface specification

Conditions: V_{DD} from 2.3 to 5 V, V_{dig} from 1.7 to 3 V, T_{amb} from -25 °C to +85 °C, unless otherwise specified						
Symbol	Parameter	Conditions	Min.	Typ.	Max.	Unit
F_{CLK}	Clock frequency				26	MHz
T_{CLK}	Clock period		38.4			ns
T_{HIGH}	Clock high time		13			ns
T_{LOW}	Clock low time		13			ns
N_{BIT}	SPI telegram length	STHV DAC-303x6	30			bits
N_{BIT}	SPI telegram length	STHV DAC-303x6	32			bits
TCS_{setup}	CS setup time	70% of rising edge of CS to 30% of rising edge of first clock cycle	5			ns
TCS_{hold}	CS hold time	30% of falling edge of last CLK cycle to 70% of falling edge of CS	5			ns
TD_{setup}	DATA setup time	Relative to 30% of CLK rising edge	4			ns
TD_{hold}	DATA hold time	Relative to 70% of CLK rising edge	4			ns
C_{CLK}	CLK pin input capacitance	$V_{OSC} = 30\text{ mV}$, $F = 1\text{ MHz}$			5	pF
C_{DATA}	DATA pin input capacitance				5	pF
C_{CS}	CS pin input capacitance				5	pF

In [Figure 6: 3-wire serial interface description](#) the data is presented on the falling edge of CLK, and latched on the rising edge of CLK. Command is latched on the falling edge of CS.

Figure 6. 3-wire serial interface description

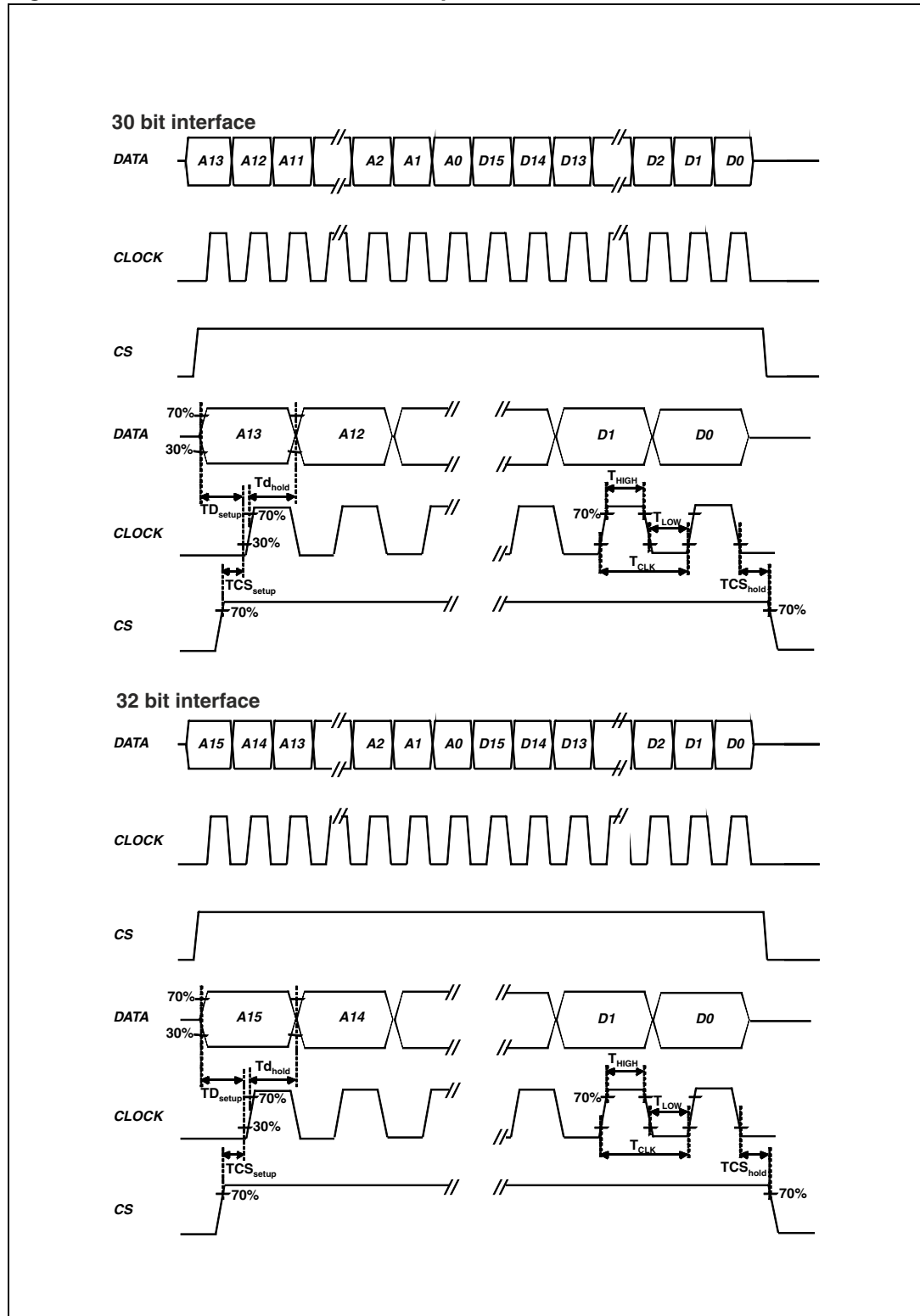

6 Serial interface frame structure

Table 11. 30-bit frame address decoding

A13	A12	A11	A10	A9	A8	A7	A6	A5	A4	A3	A2	A1	A0
0	1	0	1	0	0	1	0	0	X	X	X	X	X
Fixed		Tuner		Device ID				Register address for operation					

Table 12. 32-bit frame address decoding

A15	A14	A13	A12	A11	A10	A9	A8	A7	A6	A5	A4	A3	A2	A1	A0
1	1	0	1	0	1	0	0	1	0	0	X	X	X	X	X
Fixed		Tuner		Device ID				Register address for operation							

Table 13. Register decoding

Command	A4	A3	A2	A1	A0	DATA
#1	0	0	0	0	0	<15:8> reserved <7:0> DAC C
#2	0	0	0	0	1	<15:8> DAC B <7:0> DAC A
#3	1	0	0	0	0	Mode selection
#4	1	1	0	0	0	Reserved
#5	1	0	0	1	0	Reserved

Table 14. Data decoding for data register [00000]

D15	D14	D13	D12	D11	D10	D9	D8	D7	D6	D5	D4	D3	D2	D1	D0
0	0	0	0	0	0	0	0	bit7	bit6	bit5	bit4	bit3	bit2	bit1	bit0
Reserved								DAC C							

Table 15. Data decoding for data register [00001]

D15	D14	D13	D12	D11	D10	D9	D8	D7	D6	D5	D4	D3	D2	D1	D0
bit7	bit6	bit5	bit4	bit3	bit2	bit1	bit0	bit7	bit6	bit5	bit4	bit3	bit2	bit1	bit0
DAC B								DAC A							

Table 16. Data decoding for mode selection register [10000]

D15	D14	D13	D12	D11	D10	D9	D8	D7	D6	D5	D4	D3	D2	D1	D0
0	0	0	1	DAC_BOOST			Mode	0	0	DAC A	DAC B	DAC C	0		

Table 17. HV-DAC mode selection - Register [10000]

D11	D10	D9	D8	D7	D6	D3	D2	D1	Comments	
DAC boost				Mode		DAC A	DAC B	DAC C		
0	0	0	0	Active mode		x	x	x	VHV = 15V	
0	0	0	1			x	x	x	VHV = 16V	
0	0	1	0			x	x	x	VHV = 17V	
0	0	1	1			x	x	x	VHV = 18V	
0	1	0	0			x	x	x	VHV = 19V	
0	1	0	1			x	x	x	VHV = 20V	
0	1	1	0			x	x	x	VHV = 21V	
0	1	1	1			x	x	x	VHV = 22V	
1	0	0	0			x	x	x	VHV = 23V	
1	0	0	1			x	x	x	VHV = 24V	
1	0	1	0			x	x	x	VHV = 25V	
1	0	1	1			x	x	x	VHV = 26V	
1	1	0	0			x	x	x	VHV = 27V	
1	1	0	1			x	x	x	VHV = 28V	
1	1	1	0			x	x	x	VHV = 29V	
1	1	1	1	x	x	x	VHV = 30V			
x	x	x	x	0	0	x	x	x	Shutdown mode	
x	x	x	x	0	1	x	x	x	reserved	
x	x	x	x	1	0	x	x	x	Active mode	
x	x	x	x	1	1	x	x	x	reserved	
x	x	x	x	1	0	0	0	0	Active mode / DAC outputs in high Z-state	Any DAC outputs combination possible, as described in Table 6 .
x	x	x	x	1	0	1	1	1	Active mode / DAC outputs enabled	

Table 18. HVDAC mode selection default settings - Register [10000]

D11	D10	D9	D8	D7	D6	D3	D2	D1		
DAC boost				Mode		DAC A	DAC B	DAC C		
0	0	0	0	0	0	0	0	0		

Table 19. Data registers [00000] default settings

D15	D14	D13	D12	D11	D10	D9	D8	D7	D6	D5	D4	D3	D2	D1	D0
0	0	0	0	0	0	0	0	0	0	0	0	0	0	0	0
Reserved								DAC C							

Table 20. Data registers [00001] default settings

D15	D14	D13	D12	D11	D10	D9	D8	D7	D6	D5	D4	D3	D2	D1	D0
0	0	0	0	0	0	0	0	0	0	0	0	0	0	0	0
DAC B								DAC A							

7 Application schematic

Figure 7. Recommended application schematic

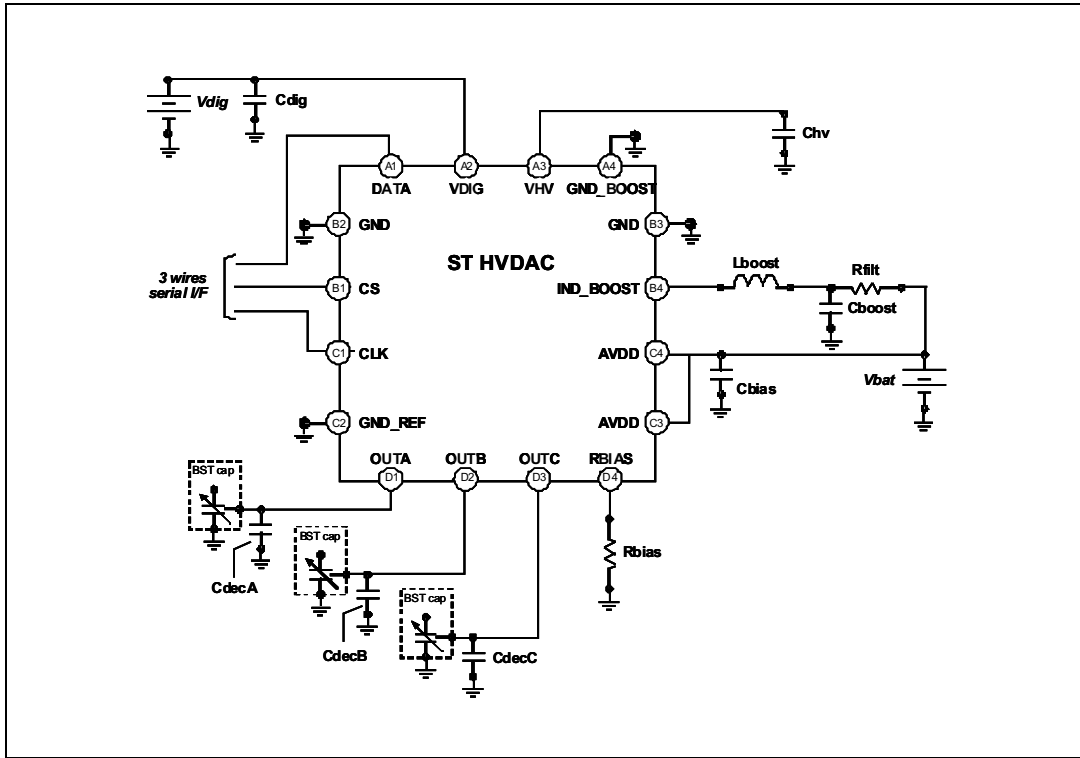

Figure 8. Recommended PCB layout

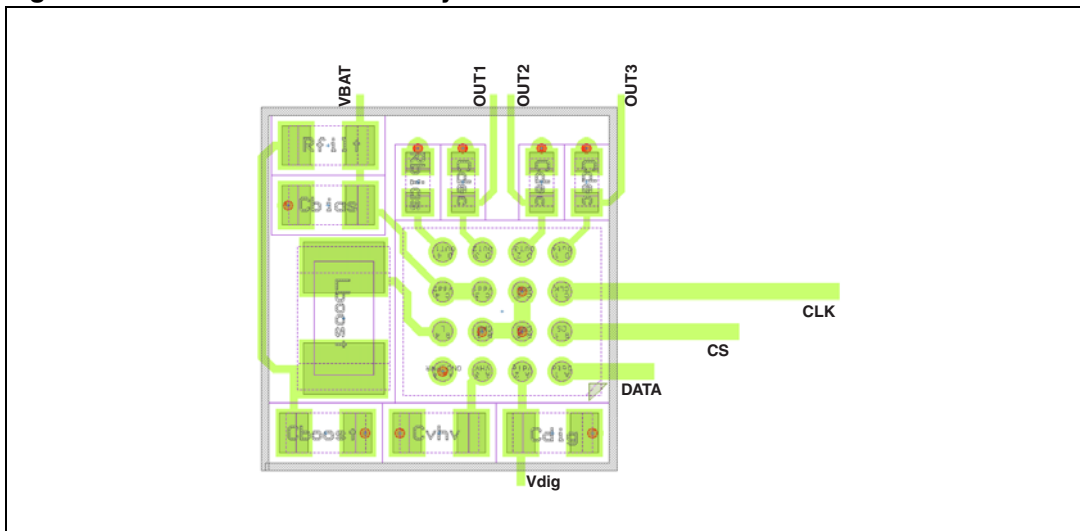

Table 21. Recommended external BOM

Component	Description	Nominal value	Package (inch)	Package (mm)	Recommended P/N
C_{boost}	Boost supply capacitor	1 μF	0402	1005	Murata: GRM155R60J105KE19D
L_{boost}	Boost inductance	15 μH	0603	1608	COILCRAFT: 0603LS-153XGL
				2014	ABCO: LPS181210T-150M
R_{filt}	Decoupling resistor, 5%	3.3 Ω	0402	1005	Vishay: CRCW04023R30JNED
C_{dig}	Digital supply decoupling	100 nF	0402	1005	Murata: GRM155R71C104KA88D
C_{bias}	Analog supply decoupling	1 μF	0402	1005	Murata: GRM155R60J105KE19D
R_{bias}	Reference bias resistor, 1%	110 k Ω	0201	0603	Multicomp: MCRE000189
C_{hv}	Boost output capacitance, 50 V	22 nF	0402	1005	Murata: GRM155R71H223KA12
					Semco: CL21B223KBCNNNC
C_{dec}	Decoupling capacitance, 50 V	100 pF	0201	0603	TDK: C0603COG1H101J

8 Ordering information schemes

Figure 9. Ordering information scheme for 30-bit serial peripheral interface

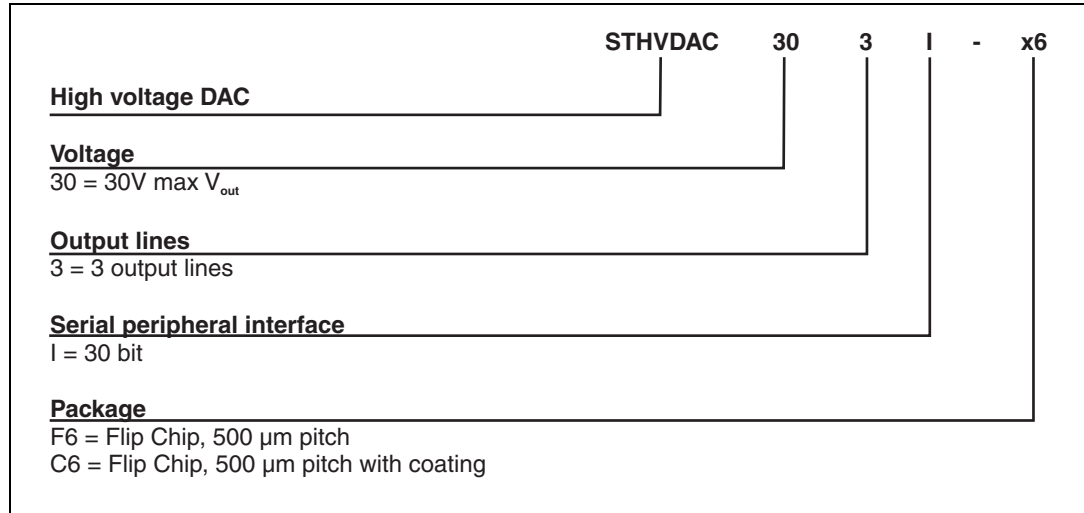
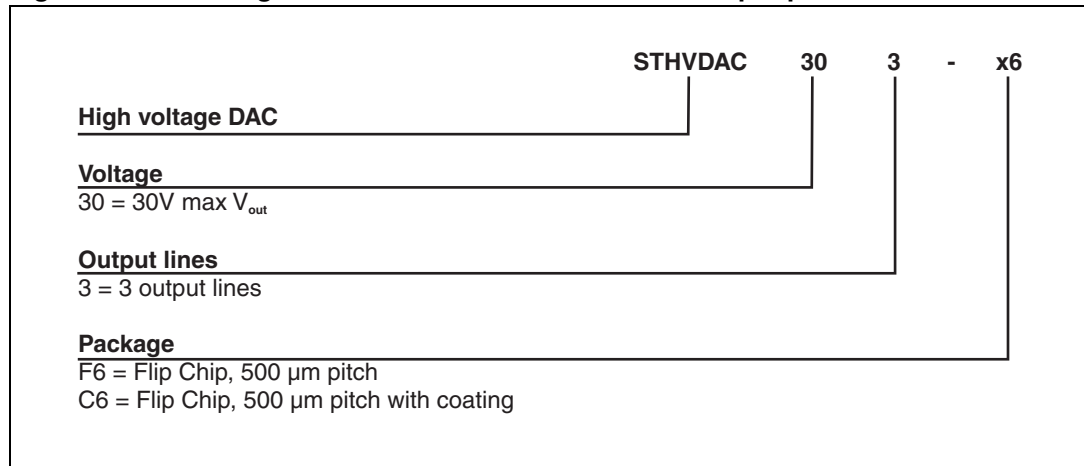

Figure 10. Ordering information scheme for 32-bit serial peripheral interface



9 Package information

- Epoxy meets UL94, V0
- Lead-free package

In order to meet environmental requirements, ST offers these devices in different grades of ECOPACK® packages, depending on their level of environmental compliance. ECOPACK® specifications, grade definitions and product status are available at: www.st.com. ECOPACK® is an ST trademark.

Figure 11. Package dimensions

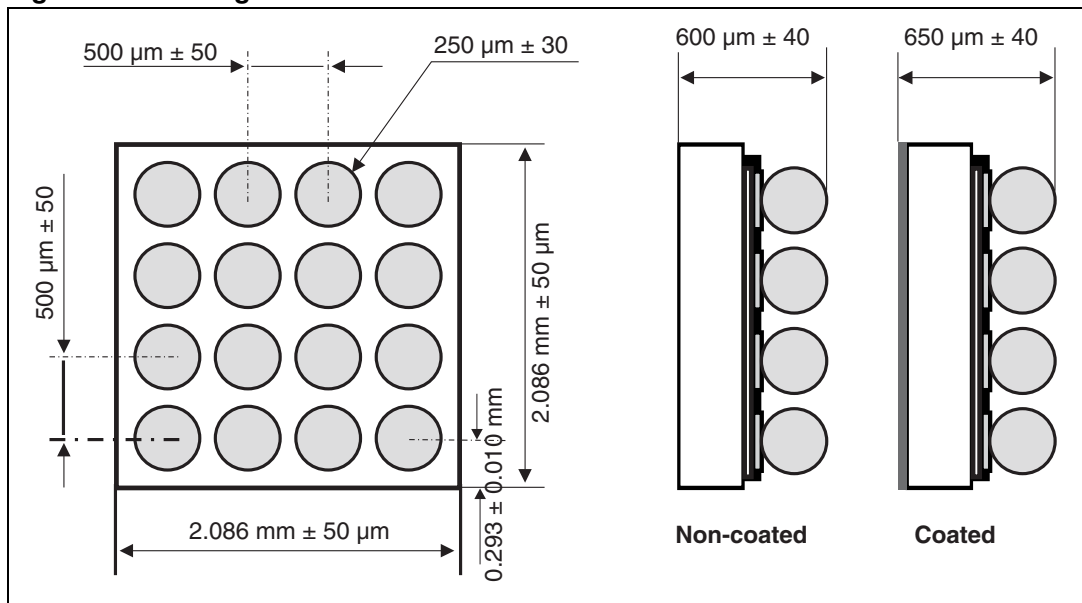

Figure 12. Footprint

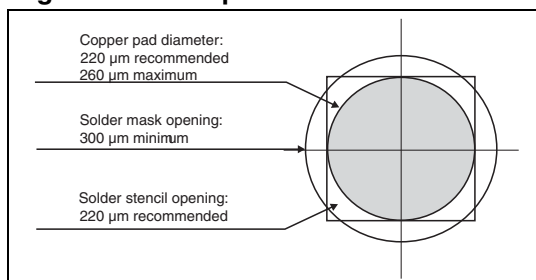

Figure 13. Marking

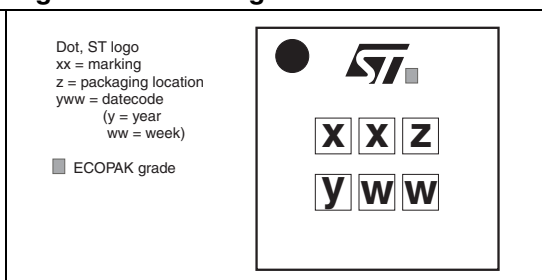
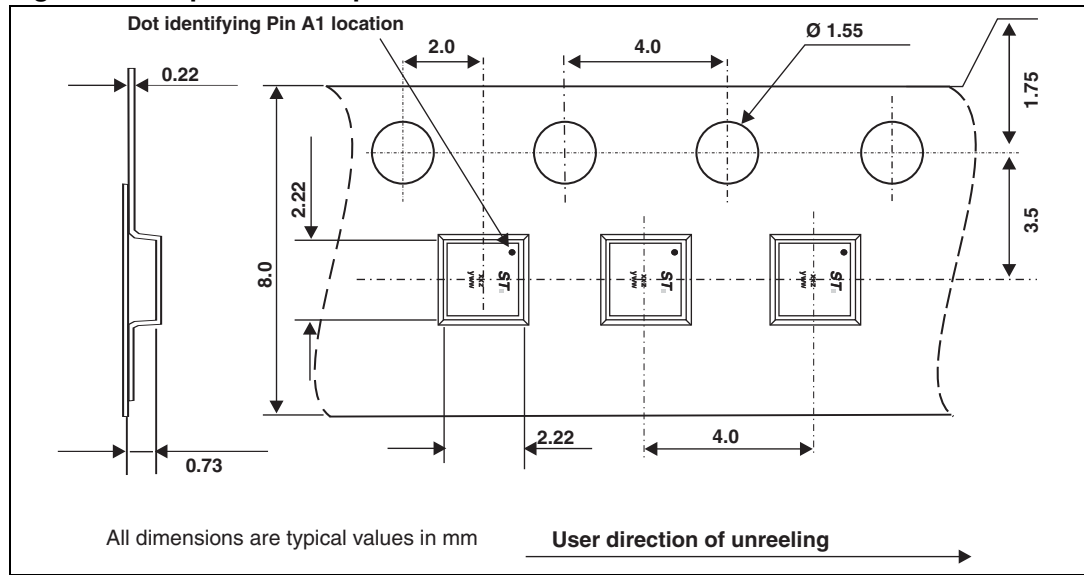

Figure 14. Tape and reel specification



10 Ordering information

Table 22. Ordering information

Order code	SPI	Marking	Package	Weight	Base qty	Delivery mode
STHVDAC-303IF6	30 bits	PC	Flip Chip	5 mg	5000	Tape and reel
STHVDAC-303IC6	30 bits	PE	Coated Flip Chip	5.3 mg		
STHVDAC-303F6	32 bits	PA	Flip Chip	5 mg		
STHVDAC-303C6	32 bits	PD	Coated Flip Chip	5.3 mg		

Note: More information is available in the STMicroelectronics Application note: AN1235: "Flip Chip: Package description and recommendations for use"

11 Revision history

Table 23. Document revision history

Date	Revision	Changes
14-Mar-2011	1	Initial release.
04-Apr-2012	2	Corrected typographical error in <i>Application</i> .
05-Nov-2012	3	Updated document status.

Please Read Carefully:

Information in this document is provided solely in connection with ST products. STMicroelectronics NV and its subsidiaries ("ST") reserve the right to make changes, corrections, modifications or improvements, to this document, and the products and services described herein at any time, without notice.

All ST products are sold pursuant to ST's terms and conditions of sale.

Purchasers are solely responsible for the choice, selection and use of the ST products and services described herein, and ST assumes no liability whatsoever relating to the choice, selection or use of the ST products and services described herein.

No license, express or implied, by estoppel or otherwise, to any intellectual property rights is granted under this document. If any part of this document refers to any third party products or services it shall not be deemed a license grant by ST for the use of such third party products or services, or any intellectual property contained therein or considered as a warranty covering the use in any manner whatsoever of such third party products or services or any intellectual property contained therein.

UNLESS OTHERWISE SET FORTH IN ST'S TERMS AND CONDITIONS OF SALE ST DISCLAIMS ANY EXPRESS OR IMPLIED WARRANTY WITH RESPECT TO THE USE AND/OR SALE OF ST PRODUCTS INCLUDING WITHOUT LIMITATION IMPLIED WARRANTIES OF MERCHANTABILITY, FITNESS FOR A PARTICULAR PURPOSE (AND THEIR EQUIVALENTS UNDER THE LAWS OF ANY JURISDICTION), OR INFRINGEMENT OF ANY PATENT, COPYRIGHT OR OTHER INTELLECTUAL PROPERTY RIGHT.

UNLESS EXPRESSLY APPROVED IN WRITING BY TWO AUTHORIZED ST REPRESENTATIVES, ST PRODUCTS ARE NOT RECOMMENDED, AUTHORIZED OR WARRANTED FOR USE IN MILITARY, AIR CRAFT, SPACE, LIFE SAVING, OR LIFE SUSTAINING APPLICATIONS, NOR IN PRODUCTS OR SYSTEMS WHERE FAILURE OR MALFUNCTION MAY RESULT IN PERSONAL INJURY, DEATH, OR SEVERE PROPERTY OR ENVIRONMENTAL DAMAGE. ST PRODUCTS WHICH ARE NOT SPECIFIED AS "AUTOMOTIVE GRADE" MAY ONLY BE USED IN AUTOMOTIVE APPLICATIONS AT USER'S OWN RISK.

Resale of ST products with provisions different from the statements and/or technical features set forth in this document shall immediately void any warranty granted by ST for the ST product or service described herein and shall not create or extend in any manner whatsoever, any liability of ST.

ST and the ST logo are trademarks or registered trademarks of ST in various countries.

Information in this document supersedes and replaces all information previously supplied.

The ST logo is a registered trademark of STMicroelectronics. All other names are the property of their respective owners.

© 2012 STMicroelectronics - All rights reserved

STMicroelectronics group of companies

Australia - Belgium - Brazil - Canada - China - Czech Republic - Finland - France - Germany - Hong Kong - India - Israel - Italy - Japan - Malaysia - Malta - Morocco - Philippines - Singapore - Spain - Sweden - Switzerland - United Kingdom - United States of America

www.st.com