

# **PCD C Compiler Reference Manual**

---

June 2012



# Table of Contents

|   |    |
|---|----|
| Overview.....                           | 1  |
| PCD.....                                | 1  |
| PCW Overview.....                       | 1  |
| Technical Support.....                  | 10 |
| Directories.....                        | 10 |
| File Formats.....                       | 10 |
| Invoking the Command Line Compiler..... | 11 |
| Program Syntax.....                     | 15 |
| Overall Structure.....                  | 15 |
| Comment.....                            | 15 |
| Trigraph Sequences.....                 | 16 |
| Multiple Project Files.....             | 17 |
| Multiple Compilation Units.....         | 17 |
| Example.....                            | 28 |
| STATEMENTS.....                         | 31 |
| Statements.....                         | 31 |
| if.....                                 | 32 |
| while.....                              | 32 |
| do.....                                 | 33 |
| do-while.....                           | 33 |
| for.....                                | 33 |
| switch.....                             | 34 |
| return.....                             | 34 |
| goto.....                               | 35 |
| label.....                              | 35 |
| break.....                              | 35 |
| continue.....                           | 36 |
| expr.....                               | 36 |
| ;.....                                  | 36 |
| stmt.....                               | 36 |
| Expressions.....                        | 37 |
| Expressions.....                        | 37 |
| Operators.....                          | 38 |
| Operator Precedence.....                | 39 |
| Reference Parameters.....               | 40 |
| Variable Argument Lists.....            | 40 |
| Default Parameters.....                 | 41 |
| Overloaded Functions.....               | 41 |
| DATA DEFINITIONS.....                   | 43 |
| Basic and Special types.....            | 43 |
| Declarations.....                       | 46 |
| Non-RAM Data Definitions.....           | 46 |
| Using Program Memory for Data.....      | 48 |
| Function Definition.....                | 49 |
| Functional Overviews.....               | 51 |
| I2C.....                                | 51 |

TEST PCD

|                                   |     |
|-----------------------------------|-----|
| ADC.....                          | 52  |
| Analog Comparator .....           | 53  |
| CAN Bus .....                     | 54  |
| Configuration Memory .....        | 58  |
| CRC .....                         | 58  |
| DAC.....                          | 59  |
| Data Eeprom .....                 | 60  |
| DCI.....                          | 61  |
| DMA .....                         | 62  |
| Data Signal Modulator.....        | 63  |
| Extended RAM .....                | 64  |
| General Purpose I/O .....         | 65  |
| Input Capture .....               | 66  |
| Internal Oscillator .....         | 67  |
| Interrupts.....                   | 68  |
| Linker .....                      | 69  |
| Output Compare/PWM Overview ..... | 69  |
| Motor Control PWM.....            | 70  |
| PMP/EPMP .....                    | 71  |
| Program Eeprom.....               | 72  |
| QEI .....                         | 75  |
| RS232 I/O .....                   | 75  |
| RTCC .....                        | 77  |
| RTOS .....                        | 78  |
| SPI .....                         | 80  |
| TimerA.....                       | 81  |
| TimerB.....                       | 82  |
| Timers .....                      | 83  |
| Voltage Reference.....            | 84  |
| WDT or Watch Dog Timer .....      | 85  |
| PRE-PROCESSOR .....               | 87  |
| #ASM #ENDASM .....                | 87  |
| #BANK_DMA .....                   | 99  |
| #BANKX .....                      | 100 |
| #BANKY .....                      | 100 |
| #BIT.....                         | 101 |
| #BUILD.....                       | 101 |
| #BYTE .....                       | 103 |
| #CASE .....                       | 103 |
| _DATE_ .....                      | 104 |
| #DEFINE .....                     | 104 |
| #DEFINEDINC .....                 | 105 |
| #DEVICE.....                      | 106 |
| _DEVICE_ .....                    | 108 |
| #ERROR .....                      | 109 |
| #EXPORT (options).....            | 109 |
| __FILE_ .....                     | 111 |
| __FILENAME__ .....                | 111 |
| #FILL_ROM.....                    | 111 |

## Table of Contents

|   |     |
|---|-----|
| #FUSES .....                            | 112 |
| #HEXCOMMENT .....                       | 113 |
| #ID .....                               | 113 |
| #IF expr #ELSE #ELIF #ENDIF .....       | 114 |
| #IFDEF #IFNDEF #ELSE #ELIF #ENDIF ..... | 115 |
| #IGNORE_WARNINGS .....                  | 116 |
| #IMPORT (options) .....                 | 116 |
| #INCLUDE .....                          | 117 |
| #INLINE .....                           | 118 |
| #INT_xxxx .....                         | 118 |
| #INT_DEFAULT .....                      | 120 |
| __LINE__ .....                          | 120 |
| #LIST .....                             | 120 |
| #LINE .....                             | 121 |
| #LOCATE .....                           | 121 |
| #MODULE .....                           | 122 |
| #NOLIST .....                           | 122 |
| #OCS .....                              | 123 |
| #OPT .....                              | 123 |
| #ORG .....                              | 123 |
| __PCD__ .....                           | 125 |
| #PRAGMA .....                           | 125 |
| #RECURSIVE .....                        | 126 |
| #RESERVE .....                          | 126 |
| #ROM .....                              | 127 |
| #SEPARATE .....                         | 128 |
| #SERIALIZE .....                        | 129 |
| #TASK .....                             | 130 |
| __TIME__ .....                          | 131 |
| #TYPE .....                             | 131 |
| #UNDEF .....                            | 133 |
| #USE DELAY .....                        | 133 |
| #USE DYNAMIC_MEMORY .....               | 134 |
| #USE FAST_IO .....                      | 134 |
| #USE FIXED_IO .....                     | 135 |
| #USE I2C .....                          | 135 |
| #USE RS232 .....                        | 137 |
| #USE RTOS .....                         | 140 |
| #USE SPI .....                          | 141 |
| #USE STANDARD_IO .....                  | 142 |
| #USE TIMER .....                        | 143 |
| #USE TOUCHPAD .....                     | 144 |
| #WARNING .....                          | 145 |
| #WORD .....                             | 145 |
| #ZERO_RAM .....                         | 146 |
| BUILT-IN FUNCTIONS Directory .....      | 147 |
| BUILT-IN-FUNCTIONS .....                | 147 |
| abs( ) .....                            | 151 |
| adc_done( ) adc_done2( ) .....          | 152 |

TEST PCD

|  |     |
|--|-----|
| assert( )  | 153 |
| atof( )  | 153 |
| atof48( ) atof64( )                                  | 154 |
| atoi( ) atol( ) atoi32( ) atoi48( ) atoi64( )        | 155 |
| bit_clear( )   | 155 |
| bit_first( )   | 156 |
| bit_last( )  | 156 |
| bit_set( )   | 157 |
| bit_test( )  | 158 |
| bsearch( )   | 158 |
| calloc( )  | 159 |
| ceil( )  | 160 |
| clear_interrupt( )                                   | 160 |
| crc_calc( ) crc_calc8( ) crc_calc16( ) crc_calc32( ) | 161 |
| crc_init(mode)                                       | 162 |
| dac_write( )   | 162 |
| dci_data_received( )                                 | 163 |
| dci_read( )  | 164 |
| dci_start( )   | 165 |
| dci_transmit_ready( )                                | 165 |
| dci_write( )   | 166 |
| delay_cycles( )                                      | 167 |
| delay_ms( )  | 167 |
| delay_us( )  | 168 |
| disable_interrupts( )                                | 169 |
| div( ) ldiv( )                                       | 170 |
| dma_start( )   | 170 |
| dma_status( )  | 171 |
| enable_interrupts( )                                 | 172 |
| erase_program_memory                                 | 173 |
| exp( )   | 173 |
| ext_int_edge( )                                      | 174 |
| fabs( )  | 174 |
| floor( )   | 175 |
| fmod( )  | 175 |
| free( )  | 176 |
| frexp( )   | 176 |
| get_capture( )                                       | 177 |
| get_motor_pwm_count( )                               | 178 |
| get_ticks( )   | 178 |
| get_timerA( )  | 179 |
| get_timerB( )  | 179 |
| get_timerx( )  | 180 |
| get_timerxy( )                                       | 180 |
| get_tris_x( )  | 181 |
| getc( ) getch( ) getchar( ) fgetc( )                 | 181 |
| getenv( )  | 182 |
| gets( ) fgets( )                                     | 185 |
| goto_address( )                                      | 186 |

## Table of Contents

|   |     |
|---|-----|
| high_speed_adc_done( )  | 186 |
| i2c_isr_state( )  | 187 |
| i2c_poll( )   | 188 |
| i2c_read( )   | 188 |
| i2c_slaveaddr( )  | 189 |
| i2c_speed( )  | 190 |
| i2c_start( )  | 190 |
| i2c_stop( )   | 191 |
| i2c_write( )  | 191 |
| input( )  | 192 |
| input_change_x( )   | 193 |
| input_state( )  | 193 |
| input_x( )  | 194 |
| interrupt_active( )   | 194 |
| isalnum(char) isalpha(char) isdigit(char) islower(char) isspace(char) isupper(char)<br>isxdigit(char) iscntrl(x) isgraph(x) isprint(x) ispunct(x) | 195 |
| isamong( )  | 196 |
| itoa( )   | 197 |
| kbhit( )  | 197 |
| label_address( )  | 198 |
| labs( )   | 199 |
| ldexp( )  | 199 |
| log( )  | 200 |
| log10( )  | 200 |
| longjmp( )  | 201 |
| make8( )  | 201 |
| make16( )   | 202 |
| make32( )   | 203 |
| malloc( )   | 203 |
| memcpy( ) memmove( )  | 204 |
| memset( )   | 205 |
| modf( )   | 205 |
| _mul( )   | 206 |
| nargs( )  | 206 |
| offsetof( ) offsetofbit( )  | 207 |
| output_x( )   | 208 |
| output_bit( )   | 209 |
| output_drive( )   | 210 |
| output_float( )   | 210 |
| output_high( )  | 211 |
| output_low( )   | 211 |
| output_toggle( )  | 212 |
| perror( )   | 212 |
| pmp_address(address)  | 212 |
| pmp_output_full( ) pmp_input_full( ) pmp_overflow( ) pmp_error( ) pmp_timeout( )  | 213 |
| pmp_read( )   | 214 |
| port_x_pullups( )   | 216 |
| pow( ) pwr( )   | 216 |
| printf( ) fprintf( )  | 217 |

TEST PCD

|  |     |
|--|-----|
| psp_output_full( ) psp_input_full( ) psp_overflow( ) psp_error( ) psp_timeout( ) ..... | 219 |
| psp_read( ) .....  | 219 |
| psp_write( ) .....   | 220 |
| putc( ) putchar( ) fputc( ) .....  | 221 |
| puts( ) fputs( ) .....   | 221 |
| qei_get_count( ) .....   | 222 |
| qei_set_count( ) .....   | 222 |
| qei_status( ) .....  | 223 |
| qsort( ) .....   | 223 |
| rand( ) .....  | 224 |
| read_adc( ) read_adc2( ) .....   | 224 |
| read_configuration_memory( ) .....   | 225 |
| read_eeprom( ) .....   | 226 |
| read_extended_ram( ) .....   | 226 |
| read_high_speed_adc( ) .....   | 227 |
| read_program_memory( ) .....   | 228 |
| read_rom_memory( ) .....   | 229 |
| realloc( ) .....   | 229 |
| reset_cpu( ) .....   | 230 |
| restart_cause( ) .....   | 230 |
| restart_wdt( ) .....   | 231 |
| rotate_left( ) .....   | 232 |
| rotate_right( ) .....  | 233 |
| rtc_alarm_read( ) .....  | 233 |
| rtc_alarm_write( ) .....   | 234 |
| rtc_read( ) .....  | 234 |
| rtc_write( ) .....   | 235 |
| rtos_await( ) .....  | 235 |
| rtos_disable( ) .....  | 235 |
| rtos_enable( ) .....   | 236 |
| rtos_msg_poll( ) .....   | 236 |
| rtos_msg_read( ) .....   | 237 |
| rtos_msg_send( ) .....   | 237 |
| rtos_overrun( ) .....  | 238 |
| rtos_run( ) .....  | 238 |
| rtos_signal( ) .....   | 238 |
| rtos_stats( ) .....  | 239 |
| rtos_terminate( ) .....  | 239 |
| rtos_wait( ) .....   | 240 |
| rtos_yield( ) .....  | 240 |
| set_adc_channel( ) set_adc_channel2( ) .....   | 241 |
| set_compare_time( ) .....  | 241 |
| set_motor_pwm_duty( ) .....  | 242 |
| set_motor_pwm_event( ) .....   | 242 |
| set_motor_unit( ) .....  | 243 |
| set_pullup( ) .....  | 243 |
| set_ticks( ) .....   | 244 |
| set_timerA( ) .....  | 245 |
| set_timerB( ) .....  | 245 |



## Table of Contents

|   |     |
|---|-----|
| set_timerx( ) .....   | 246 |
| set_timerxy( ) .....  | 246 |
| set_tris_x( ) .....   | 247 |
| set_uart_speed( ) .....   | 247 |
| setjmp( ) .....   | 248 |
| setup_adc(mode) setup_adc2(mode).....   | 249 |
| setup_adc_ports( ) setup_adc_ports2( ).....   | 249 |
| setup_capture( ) .....  | 250 |
| setup_comparator( ) .....   | 251 |
| setup_compare( ) .....  | 251 |
| setup_crc(mode) .....   | 252 |
| setup_dac( ) .....  | 253 |
| setup_dci( ) .....  | 253 |
| setup_dma( ) .....  | 255 |
| setup_high_speed_adc( ).....  | 255 |
| setup_high_speed_adc_pair( ).....   | 256 |
| setup_low_volt_detect( ) .....  | 257 |
| setup_motor_pwm( ) .....  | 257 |
| setup_oscillator( ).....  | 258 |
| setup_pmp(option,address_mask) .....  | 259 |
| setup_power_pwm_pins( ) .....   | 260 |
| setup_psp(option,address_mask) .....  | 260 |
| setup_qei( ) .....  | 261 |
| setup_rtc( ) .....  | 262 |
| setup_rtc_alarm( ) .....  | 262 |
| setup_spi( ) setup_spi2( ).....   | 263 |
| setup_timerx( ) .....   | 264 |
| setup_timer_A( ).....   | 265 |
| setup_timer_B( ).....   | 266 |
| setup_uart( ) .....   | 266 |
| setup_vref( ) .....   | 267 |
| setup_wdt( ) .....  | 268 |
| shift_left( ) .....   | 268 |
| shift_right( ) .....  | 269 |
| sin( ) cos( ) tan( ) asin( ) acos( ) atan( ) sinh( ) cosh( ) tanh( ) atan2( ) .....             | 270 |
| sleep( ) .....  | 271 |
| spi_data_is_in( ) spi_data_is_in2( ).....   | 272 |
| spi_read( ) spi_read2( ) .....  | 272 |
| spi_write( ) spi_write2( ) .....  | 273 |
| spi_xfer( ) .....   | 273 |
| sprintf( ) .....  | 274 |
| sqrt( ).....  | 274 |
| srand( ).....   | 275 |
| STANDARD STRING FUNCTIONS( ) memchr( ) memcmp( ) strcat( ) strchr( )                            |     |
| strcmp( ) strcoll( ) strcspn( ) strerror( ) strcmp( ) strlen( ) strlwr( ) strncat( ) strncmp( ) |     |
| strncpy( ) strpbrk( ) strrchr( ) strspn( ) strstr( ) strxfrm( ).....                            | 275 |
| strcat( ).....  | 277 |
| strchr( ).....  | 277 |
| strcmp( ) .....   | 277 |

## TEST PCD

|  |     |
|--|-----|
| strcoll( ) .....   | 277 |
| strcpy( ) strcpy( ) .....                                    | 278 |
| STRCSPN( ) .....   | 278 |
| strlen( ) .....  | 278 |
| strlwr( ) .....  | 278 |
| strncat( ) .....   | 279 |
| strncmp( ) .....   | 279 |
| strncpy( ) .....   | 279 |
| strpbrk( ) .....   | 279 |
| strchr( ) .....  | 279 |
| strcspn( ) .....   | 279 |
| strstr( ) .....  | 279 |
| strtod( ) strtod( ) strtod48( ) .....                        | 279 |
| strtok( ) .....  | 280 |
| strtol( ) .....  | 281 |
| strtoul( ) .....   | 282 |
| strxfrm( ) .....   | 283 |
| swap( ) .....  | 283 |
| tolower( ) toupper( ) .....                                  | 283 |
| touchpad_getc( ) .....                                       | 284 |
| touchpad_hit( ) .....  | 285 |
| touchpad_state( ) .....                                      | 285 |
| va_arg( ) .....  | 286 |
| va_end( ) .....  | 287 |
| va_start .....   | 287 |
| write_configuration_memory( ) .....                          | 288 |
| write_eeprom( ) .....  | 289 |
| write_extended_ram( ) .....                                  | 289 |
| write_program_memory( ) .....                                | 290 |
| Standard C Include Files .....                               | 291 |
| errno.h .....  | 291 |
| float.h .....  | 291 |
| limits.h .....   | 292 |
| locale.h .....   | 293 |
| setjmp.h .....   | 293 |
| stddef.h .....   | 293 |
| stdio.h .....  | 293 |
| stdlib.h .....   | 293 |
| Error Messages .....   | 295 |
| Compiler Error Messages .....                                | 295 |
| Compiler Warning Messages .....                              | 305 |
| Compiler Warning Messages .....                              | 305 |
| Common Questions and Answers .....                           | 309 |
| How are type conversions handled? .....                      | 309 |
| How can a constant data table be placed in ROM? .....        | 310 |
| How can I use two or more RS-232 ports on one PIC®? .....    | 311 |
| How do I directly read/write to internal registers? .....    | 312 |
| How do I do a printf to a string? .....                      | 312 |
| How do I get getc() to timeout after a specified time? ..... | 313 |

## Table of Contents

|  |     |
|--|-----|
| How do I make a pointer to a function? .....                         | 314 |
| How do I wait only a specified time for a button press?.....         | 314 |
| How do I write variables to EEPROM that are not a word? .....        | 315 |
| How does one map a variable to an I/O port? .....                    | 315 |
| How does the compiler determine TRUE and FALSE on expressions? ..... | 316 |
| How does the PIC® connect to a PC? .....                             | 317 |
| How does the PIC® connect to an I2C device? .....                    | 318 |
| How much time do math operations take? .....                         | 319 |
| What are the various Fuse options for the dsPIC/PIC 24 chips?.....   | 319 |
| What can be done about an OUT OF RAM error? .....                    | 321 |
| What is an easy way for two or more PICs® to communicate? .....      | 322 |
| What is an easy way for two or more PICs® to communicate? .....      | 323 |
| What is the format of floating point numbers? .....                  | 323 |
| Why does the .LST file look out of order? .....                      | 325 |
| Why is the RS-232 not working right? .....                           | 326 |
| Example Programs .....   | 329 |
| EXAMPLE PROGRAMS .....   | 329 |
| Software License Agreement.....                                      | 341 |
| SOFTWARE LICENSE AGREEMENT .....                                     | 341 |
| Index.....   | 343 |



# OVERVIEW



## PCD

PCD is a C Compiler for Microchip's 24bit opcode family of microcontrollers, which include the dsPIC30, dsPIC33 and PIC24 families. The compiler is specifically designed to meet the unique needs of the dsPIC® microcontroller. This allows developers to quickly design applications software in a more readable, high-level language.

The compiler can efficiently implement normal C constructs, input/output operations, and bit twiddling operations. All normal C data types are supported along with special built in functions to perform common functions in the MPU with ease.

Extended constructs like bit arrays, multiple address space handling and effective implementation of constant data in Rom make code generation very effective.

## PCW Overview

Beginning in version 4.XXX of PCW, the menus and toolbars are set-up in specially organized Ribbons. Each Ribbon relates to a specific type of activity and is only shown when selected. CCS has included a "User Toolbar" Ribbon that allows the user to customize the Ribbon for individual needs.

### File Menu

Click on this icon for the following items:



|           |  |
|-----------|--|
| New       | Creates a new File   |
| Open      | Opens a file to the editor. Includes options for Source, Project, Output, RTF, Flow Chart, Hex or Text. Ctrl+O is the shortcut.                                  |
| Close     | Closes the file currently open for editing. Note, that while a file is open in PCW for editing, no other program may access the file. Shift+F11 is the shortcut. |
| Close All | Closes all files open in the PCW.  |
| Save      | Saves the file currently selected for editing. Ctrl+S is the shortcut.   |
| Save      | Prompts for a file name to save the currently selected file.   |

## TEST PCD

|              |  |
|--------------|--|
| As           |  |
| Save All     | All open files are saved.  |
| Encrypt      | Creates an encrypted include file. The standard compiler #include directive will accept files with this extension and decrypt them when read. This allows include files to be distributed without releasing the source code. |
| Print        | Prints the currently selected file.  |
| Recent Files | The right-side of the menu has a Recent Files list for commonly used files.  |
| Exit         | The bottom of the menu has an icon to terminate PCW.   |

## Project Menu Ribbon

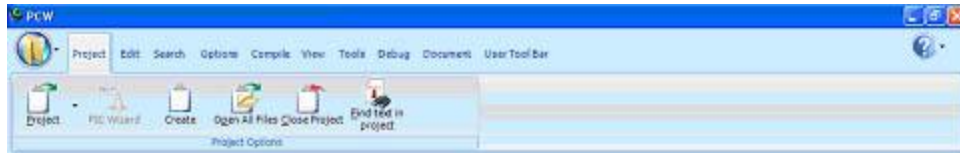

|                      |   |
|----------------------|---|
| Project              | Open an existing project (.PJT) file as specified and the main source file is loaded.   |
| PIC Wizard           | This command is a fast way to start a new project. It will bring up a screen with fill-in-the-blanks to create a new project. When items such as RS232 I/O, i2C, timers, interrupts, A/D options, drivers and pin name are specified by the user, the Wizard will select required pins and pins that may have combined use. After all selections are made, the initial .c and .h files are created with #defines, #includes and initialization commands required for the project. |
| Create               | Create a new project with the ability to add/remove source files, include files, global defines and specify output files.   |
| Open All Files       | Open all files in a project so that all include files become known for compilation.   |
| Close Project        | Close all files associated with project.  |
| Find Text in Project | Ability to search all files for specific text string.   |

## Edit Menu Ribbon



|                    |  |
|--------------------|--|
| Undo               | Undoes the last deletion   |
| Redo               | Re-does the last undo  |
| Cut                | Moves the selected text from the file to the clipboard.                |
| Copy               | Copies the selected text to the clipboard.                             |
| Paste              | Applies the clipboard contents to the cursor location.                 |
| Unindent Selection | Selected area of code will not be indented.                            |
| Indent Selection   | Selected area of code will be properly indented.                       |
| Select All         | Highlighting of all text.  |
| Copy from File     | Copies the contents of a file to the cursor location.                  |
| Past to File       | Applies the selected text to a file.                                   |
| Macros             | Macros for recording, saving and loading keystrokes and mouse-strokes. |

## Search Menu Ribbon



|                      |   |
|----------------------|---|
| Find                 | Locate text in file.                                    |
| Find Text in Project | Searches all files in project for specific text string. |

## TEST PCD

|                          |   |
|--------------------------|---|
| Find Next Word at Cursor | Locates the next occurrence of the text selected in the file. |
| Goto Line                | Cursor will move to the user specified line number.           |
| Toggle Bookmark          | Set/Remove bookmark (0-9) at the cursor location.             |
| Goto Bookmark            | Move cursor to the specified bookmark (0-9).                  |

## Options Menu Ribbon



|                             |  |
|-----------------------------|--|
| Project Options             | Add/remove files, include files, global defines and output files.  |
| Editor Properties           | Allows user to define the set-up of editor properties for Windows options.   |
| Tools                       | Window display of User Defined Tools and options to add and apply.   |
| Software Updates Properties | Ability for user to select which software to update, frequency to remind Properties user and where to archive files. |
| Printer Setup               | Set the printer port and paper and other properties for printing.  |
| Toolbar Setup               | Customize the toolbar properties to add/remove icons and keyboard commands.  |
| File Associations           | Customize the settings for files according to software being used.   |



## Compile Menu Ribbon



|              |   |
|--------------|---|
| Compile      | Compiles the current project in status bar using the current compiler.  |
| Build        | Compiles one or more files within a project.  |
| Compiler     | Pull-down menu to choose the compiler needed.   |
| Lookup Part  | Choose a device and the compiler needed will automatically be selected.   |
| Program Chip | Lists the options of CCS ICD or Mach X programmers and will connect to SLOW program.  |
| Debug        | Allows for input of .hex and will output .asm for debugging.  |
| C/ASM List   | Opens listing file in read-only mode. Will show each C source line code and the associated assembly code generated.                             |
| Symbol Map   | Opens the symbol file in read-only mode. Symbol map shows each register location and what program variable are saved in each location.          |
| Call Tree    | Opens the tree file in read-only mode. The call tree shows each function and what functions it calls along with the ROM and RAM usage for each. |
| Statistics   | Opens the statistics file in read-only mode. The statistics file shows each function, the ROM and RAM usage by file, segment and name.          |
| Debug File   | Opens the debug file in read-only mode. The listing file shows each C source line code and the associated assembly code generated.              |

## View Menu Ribbon



|                  |  |
|------------------|--|
| Valid Interrupts | This displays a list of valid interrupts used with the #INT_keyword for the chip used in the current project. The interrupts for other chips can be viewed using the |
|------------------|--|

## TEST PCD

drop down menu.

|                    |   |
|--------------------|---|
| Valid Fuses        | This displays a list of valid FUSE used with the #FUSES directive associated with the chip used in the current project. The fuses for other chips can be viewed using the drop down menu. |
| Data Sheets        | This tool is used to view the Manufacturer data sheets for all the Microchip parts supported by the compiler.   |
| Part Errata        | This allows user to view the errata database to see what errata is associated with a part and if the compiler has compensated for the problem.  |
| Special Registers  | This displays the special function registers associated with the part.  |
| New Edit Window    | This will open a new edit window which can be tiled to view files side by side.   |
| Dock Editor Window | Selecting this checkbox will dock the editor window into the IDE.   |
| Project Files      | When this checkbox is selected, the Project files slide out tab is displayed. This will allow quicker access to all the project source files and output files.                            |
| Project List       | Selecting this checkbox displays the Project slide out tab. The Project slide out tab displays all the recent project files.  |
| Output             | Selecting this checkbox will enable the display of warning and error messages generated by the compiler.  |
| Identifier List    | Selecting this checkbox displays the Identifier slide out tab. It allows quick access to project identifiers like functions, types, variables and defines.                                |

## Tools Menu Ribbon



|               |   |
|---------------|---|
| Device Editor | This tool is used to edit the device database used by the compiler to control compilations. The user can edit the chip memory, interrupts, fuses and other peripheral settings for all the supported devices. |
|---------------|---|

|                     |   |
|---------------------|---|
| Device Selector     | This tool uses the device database to allow for parametric selection of devices. The tool displays all eligible devices based on the selection criteria.  |
| File Compare        | This utility is used to compare two files. Source or text files can be compared line by line and list files can be compared by ignoring the RAM/ROM addresses to make the comparisons more meaningful.  |
| Numeric Converter   | This utility can be used to convert data between different formats. The user can simultaneously view data in various formats like binary, hex, IEEE, signed and unsigned.                               |
| Serial Port Monitor | This tool is an easy way of connecting a PIC to a serial port. Data can be viewed in ASCII or hex format. An entire hex file can be transmitted to the PIC which is useful for bootloading application. |
| Disassembler        | This tool will take an input hex file and output an ASM.  |
| Convert Data to C   | This utility will input data from a text file and generate code in form of a #ROM or CONST statement.   |
| Extract Calibration | This tool will input a hex file and extract the calibration data to a C include file. This feature is useful for saving calibration data stored at top of program memory from certain PIC chips.        |
| MACH X              | This will call the Mach-X.exe program and will download the hex file for the current project onto the chip.   |
| ICD                 | This will call the ICD.exe program and will download the hex file for the current project onto the chip.  |

## Debug Menu Ribbon



|                 |  |
|-----------------|--|
| Enable Debugger | Enables the debugger. Opens the debugger window, downloads the code and on-chip debugger and resets the target into the debugger.  |
| Reset           | This will reset the target into the debugger.  |
| Single Step     | Executes one source code line at a time. A single line of C source code or ASM code is executed depending on whether the source code or the list file tab in the editor is active. |

## TEST PCD

|               |  |
|---------------|--|
| Step Over     | This steps over the target code. It is useful for stepping over function calls.  |
| Run to Cursor | Runs the target code to the cursor. Place the cursor at the desired location in the code and click on this button to execute the code till that address.   |
| Snapshot      | This allows users to record various debugging information. Debug information like watches, ram values, data eeprom values, rom values , peripheral status can be conveniently logged. This log can be saved, printed, overwritten or appended. |
| Run Script    | This tool allows the IDE's integrated debugger to execute a C-style script. The functions and variable of the program can be accesses and the debugger creates a report of the results.  |
| Debug Windows | This drop down menu allows viewing of a particular debug tab. Click on the tab name in the drop down list which you want to view and it will bring up that tab in the debugger window.   |

## Document Menu Ribbon



|                   |   |
|-------------------|---|
| Format Source     | This utility formats the source file for indenting, color syntax highlighting, and other formatting options.  |
| Generate Document | This will call the document generator program which uses a user generated template in .RTF format to merge with comment from the source code to produce an output file in .RTF format as source code documentation. |
| RTF Editor        | Open the RTF editor program which is a fully featured RTF editor to make integration of documentation into your project easier.   |
| Flow Chart        | Opens a flow chart program for quick and easy charting. This tool can be used to generate simple graphics including schematics.   |
| Quotes            | Performs a spell check on all the words within quotes.  |
| Comments          | Performs a spell check on all the comments in your source code.   |
| Print all Files   | Print all the files of the current project.   |

## Help Menu

Click on this icon for the following items:



|                            |  |
|----------------------------|--|
| Contents                   | Help File table of contents  |
| Index                      | Help File index  |
| Keyword at Cursor          | Index search in Help File for the keyword at the cursor location. Press F1 to use this feature.                        |
| Debugger Help              | Help File specific to debugger functionality.  |
| Editor                     | Lists the Editor Keys available for use in PCW. Shft+F12 will also call this function help file page for quick review. |
| Data Types                 | Specific Help File page for basic data types.  |
| Operators                  | Specific Help File page for table of operators that may be used in PCW.  |
| Statements                 | Specific Help File page for table of commonly used statements.   |
| Preprocessor Commands      | Specific Help File page for listing of commonly used preprocessor commands.  |
| Built-in Functions         | Specific Help File page for listing of commonly used built-in functions provided by the compiler.                      |
| Technical Support          | Technical Support wizard to directly contact Technical Support via email and the ability to attach files.              |
| Check for Software Updates | Automatically invokes Download Manager to view local and current versions of software.                                 |
| Internet                   | Direct links to specific CCS website pages for additional information.   |
| About                      | Shows the version of compiler(s) and IDE installed.  |

## Technical Support

Compiler, software, and driver updates are available to download at:  
<http://www.ccsinfo.com/download>

Compilers come with 30 or 60 days of download rights with the initial purchase. One year maintenance plans may be purchased for access to updates as released.

The intent of new releases is to provide up-to-date support with greater ease of use and minimal, if any, transition difficulty.

To ensure any problem that may occur is corrected quickly and diligently, it is recommended to send an email to "x-text-underline: normal; support@ccsinfo.com or use the Technical Support Wizard in PCW. Include the version of the compiler, an outline of the problem and attach any files with the email request. CCS strives to answer technical support timely and thoroughly.

Technical Support is available by phone during business hours for urgent needs or if email responses are not adequate. Please call 262-522-6500 x32.

## Directories

The compiler will search the following directories for Include files.

- Directories listed on the command line
- Directories specified in the .PJT file
- The same directory as the source file

By default, the compiler files are put in C:\Program Files\PICC and the example programs and all Include files are in C:\Program Files\PICC\EXAMPLES.

The compiler itself is a DLL file. The DLL files are in a DLL directory by default in C:\Program Files\PICC\DLL. Old compiler versions may be kept by renaming this directory.

Compiler Version 4 and above can tolerate two compilers of different versions in the same directory. Install an older version (4.xx ) and rename the devices4.dat file to devices4X.dat where X is B for PCB, M is for PCM, and H is for PCH. Install the newer compiler and do the same rename of the devices4.dat file.

## File Formats

|      |  |
|------|--|
| .C   | This is the source file containing user C source code.   |
| .H   | These are standard or custom header files used to define pins, register, register bits, functions and preprocessor directives. |
| .PJT | This is the project file which contains information related to the project.  |

**.LST** This is the listing file which shows each C source line and the associated assembly code generated for that line.

The elements in the .LST file may be selected in PCW under Options>Project Options>File Formats

|            |   |
|------------|---|
| Match code | -Includes the HEX opcode for each instruction   |
| SFR names  | -Instead of an address a name is used. For example instead of 044 is will show CORCON   |
| Symbols    | -Shows variable names instead of addresses  |
| Interpret  | -Adds a pseudo code interpretation to the right of assembly instruction to help understand the operation.<br>For example:<br><code>LSR W4, #8, W5 : W5=W4&gt;&gt;8</code> |

**.SYM** This is the symbol map which shows each register location and what program variables are stored in each location.

**.STA** The statistics file shows the RAM, ROM, and STACK usage. It provides information on the source codes structural and textual complexities using Halstead and McCabe metrics.

**.TRE** The tree file shows the call tree. It details each function and what functions it calls along with the ROM and RAM usage for each function.

**.HEX** The compiler generates standard HEX files that are compatible with all programmers.

**.COF** This is a binary containing machine code and debugging information.

**.COD** This is a binary file containing debug information.

**.RTF** The output of the Documentation Generator is exported in a Rich Text File format which can be viewed using the RTF editor or wordpad.

**.RVF** The Rich View Format is used by the RTF Editor within the IDE to view the Rich Text File.

**.DGR** The .DGR file is the output of the flowchart maker.

**.ESYM** This file is generated for the IDE users. The file contains Identifiers and Comment information. This data can be used for automatic documentation generation and for the IDE helpers.

**.OSYM** This file is generated when the compiler is set to export a relocatable object file. This file is a .sym file for just the one unit.

## Invoking the Command Line Compiler

The command line compiler is invoked with the following command:

```
CCSC [options] [cfilename]
```

Valid options:

|     |                     |     |                                 |
|-----|---------------------|-----|---------------------------------|
| +FB | Select PCB (12 bit) | -D  | Do not create debug file        |
| +FM | Select PCM (14 bit) | +DS | Standard .COD format debug file |

## TEST PCD

|     |  |     |  |
|-----|--|-----|--|
| +FH | Select PCH (PIC18XXX)                    | +DM | .MAP format debug file   |
| +Yx | Optimization level x (0-9)               | +DC | Expanded .COD format debug file  |
| +FS | Select SXC (SX)                          | +EO | Old error file format  |
| +ES | Standard error file                      | -T  | Do not generate a tree file  |
| +T  | Create call tree (.TRE)                  | -A  | Do not create stats file (.STA)  |
| +A  | Create stats file (.STA)                 | -EW | Suppress warnings (use with +EA)   |
| +EW | Show warning messages                    | -E  | Only show first error  |
| +EA | Show all error messages and all warnings | +EX | Error/warning message format uses GCC's "brief format" (compatible with GCC editor environments) |
| +FD | Select PCD (dsPIC30/dsPIC33/PIC24)       | +DF | Enables the output of an OFF debug file.   |

The xxx in the following are optional. If included it sets the file extension:

|        |                         |        |                              |
|--------|-------------------------|--------|------------------------------|
| +LNxxx | Normal list file        | +O8xxx | 8-bit Intel HEX output file  |
| +LSxxx | MPASM format list file  | +OWxxx | 16-bit Intel HEX output file |
| +LOxxx | Old MPASM list file     | +OBxxx | Binary output file           |
| +LYxxx | Symbolic list file      | -O     | Do not create object file    |
| -L     | Do not create list file |        |                              |

|      |  |
|------|--|
| +P   | Keep compile status window up after compile        |
| +Pxx | Keep status window up for xx seconds after compile |
| +PN  | Keep status window up only if there are no errors  |
| +PE  | Keep status window up only if there are errors     |

|          |  |
|----------|--|
| +Z       | Keep scratch files on disk after compile                             |
| +DF      | COFF Debug file  |
| I+="..." | Same as I="..." Except the path list is appended to the current list |

I="..." Set include directory search path, for example:  
I="c:\picc\examples;c:\picc\myincludes"  
If no I= appears on the command line the .PJT file will be used to supply the include file paths.

|            |  |
|------------|--|
| -P         | Close compile window after compile is complete                                 |
| +M         | Generate a symbol file (.SYM)  |
| -M         | Do not create symbol file  |
| +J         | Create a project file (.PJT)   |
| -J         | Do not create PJT file   |
| +ICD       | Compile for use with an ICD  |
| #xxx="yyy" | Set a global #define for id xxx with a value of yyy, example:<br>#debug="true" |

|             |                       |
|-------------|-----------------------|
| +Gxxx="yyy" | Same as #xxx="yyy"    |
| +?          | Brings up a help file |



|             |   |
|-------------|---|
| -?          | Same as +?  |
| +STDOUT     | Outputs errors to STDOUT (for use with third party editors)   |
| +SETUP      | Install CCSC into MPLAB (no compile is done)  |
| sourceline= | Allows a source line to be injected at the start of the source file.<br>Example: CCSC +FM myfile.c sourceline="#include <16F887.h>" |
| +V          | Show compiler version (no compile is done)  |
| +Q          | Show all valid devices in database (no compile is done)   |

A / character may be used in place of a + character. The default options are as follows:  
+FM +ES +J +DC +Y9 -T -A +M +LNlst +O8hex -P -Z

If @filename appears on the CCSC command line, command line options will be read from the specified file. Parameters may appear on multiple lines in the file.

If the file CCSC.INI exists in the same directory as CCSC.EXE, then command line parameters are read from that file before they are processed on the command line.

**Examples:**

```
CCSC +FM C:\PICSTUFF\TEST.C
CCSC +FM +P +T TEST.C
```



## Overall Structure

A program is made up of the following four elements in a file:

Comment

Pre-Processor Directive

Data Definition

Function Definition

Every C program must contain a main function which is the starting point of the program execution. The program can be split into multiple functions according to their purpose and the functions could be called from main or the subfunctions. In a large project functions can also be placed in different C files or header files that can be included in the main C file to group the related functions by their category. CCS C also requires to include the appropriate device file using `#include` directive to include the device specific functionality. There are also some preprocessor directives like `#fuses` to specify the fuses for the chip and `#use delay` to specify the clock speed. The functions contain the data declarations, definitions, statements and expressions. The compiler also provides a large number of standard C libraries as well as other device drivers that can be included and used in the programs. CCS also provides a large number of built-in functions to access the various peripherals included in the PIC microcontroller.

## Comment

**Comments** – Standard Comments

A comment may appear anywhere within a file except within a quoted string. Characters between `/*` and `*/` are ignored. Characters after a `//` up to the end of the line are ignored.

**Comments for Documentation Generator-**

The compiler recognizes comments in the source code based on certain markups. The compiler recognizes these special types of comments that can be later exported for use in the documentation generator. The documentation generator utility uses a user selectable template to export these comments and create a formatted output document in Rich Text File Format. This utility is only available in the IDE version of the compiler. The source code markups are as follows.

**Global Comments** – These are named comments that appear at the top of your source code. The comment names are case sensitive and they must match the case used in the documentation template.

For example:

```
/*PURPOSE This program implements a Bootloader.  
/*AUTHOR John Doe
```

A `'''` followed by an `*` will tell the compiler that the keyword which follows it will be the named comment. The actual comment that follows it will be exported as a paragraph to the documentation generator.

## TEST PCD

Multiple line comments can be specified by adding a : after the \*, so the compiler will not concatenate the comments that follow. For example:

```
/**:CHANGES
    05/16/06  Added PWM loop
    05/27.06  Fixed Flashing problem
*/
```

Variable Comments – A variable comment is a comment that appears immediately after a variable declaration. For example:

```
int seconds; // Number of seconds since last entry
long day,    // Current day of the month
int month,  /* Current Month */
long year;   // Year
```

Function Comments – A function comment is a comment that appears just before a function declaration. For example:

```
// The following function initializes outputs
void function_foo()
{
  init_outputs();
}
```

Function Named Comments – The named comments can be used for functions in a similar manner to the Global Comments. These comments appear before the function, and the names are exported as-is to the documentation generator.

For example:

```
/**PURPOSE This function displays data in BCD format
    void display_BCD( byte n)
{
  display_routine();
}
```

## Trigraph Sequences

The compiler accepts three character sequences instead of some special characters not available on all keyboards as follows:

| Sequence | Same as |
|----------|---------|
| ??=      | #       |
| ??{      | [       |
| ??/      | \       |
| ??)      | ]       |
| ??'      | ^       |
| ??<      | {       |
| ??!      |         |
| ??>      | }       |
| ??-      | ~       |

## Multiple Project Files

When there are multiple files in a project they can all be included using the `#include` in the main file or the subfiles to use the automatic linker included in the compiler. All the header files, standard libraries and driver files can be included using this method to automatically link them.

For example: if you have `main.c`, `x.c`, `x.h`, `y.c,y.h` and `z.c` and `z.h` files in your project, you can say in:

|                  |  |                                   |                                   |                                   |
|------------------|--|-----------------------------------|-----------------------------------|-----------------------------------|
| <b>main.c</b>    | <code>#include &lt;device header file&gt;</code> | <code>#include &lt;x.c&gt;</code> | <code>#include &lt;y.c&gt;</code> | <code>#include &lt;z.c&gt;</code> |
| <code>x.c</code> | <code>#include &lt;x.h&gt;</code>                |                                   |                                   |                                   |
| <b>y.c</b>       | <code>#include &lt;y.h&gt;</code>                |                                   |                                   |                                   |
| <b>z.c</b>       | <code>#include &lt;z.h&gt;</code>                |                                   |                                   |                                   |

In this example there are 8 files and one compilation unit. `Main.c` is the only file compiled.

Note that the `#module` directive can be used in any include file to limit the visibility of the symbol in that file.

To separately compile your files see the section "multiple compilation units".

## Multiple Compilation Units

Traditionally, the CCS C compiler used only one compilation unit and multiple files were implemented with `#include` files. When using multiple compilation units, care must be given that pre-processor commands that control the compilation are compatible across all units. It is recommended that directives such as `#FUSES`, `#USE` and the device header file all put in an include file included by all units. When a unit is compiled it will output a relocatable object file (`*.o`) and symbol file (`*.osym`).

The following is an overview of a multiple compilation unit example. For the example used here, see the `MCU.zip` in the examples directory.

Files Included in Project Example:

|                        |  |
|------------------------|--|
| <code>main.c</code>    | Primary file for the first compilation unit.   |
| <code>filter.c</code>  | Primary file for the second compilation unit.  |
| <code>report.c</code>  | Primary file for the third compilation unit.   |
| <code>project.h</code> | Include file with project wide definitions that should be included by all units.                                 |
| <code>filter.h</code>  | Include file with external definitions for filter that should be included by all units that use the filter unit. |

## TEST PCD

|              |  |
|--------------|--|
| report.h     | Include file with external definitions for report that should be included by all units that use the report unit. |
| project.c    | Import file used to list the units in the project for the linker.bat file.                                       |
| project.pjt  | Project file used to list the units in the project for the build.bat file.                                       |
| build.bat    | Batch file that re-compiles files that need compiling and linking.   |
| buildall.bat | Batch file that compiles and links all units.  |
| linker.bat   | Batch file that compiles and links all units using a script.   |

### File Overview:

|  |  |   |
|--|--|---|
| <pre>main #include:     project.h     filter.h     report.h  Definitions:     main() program  Uses:     clear_data()     filter_data()     report_data_line()     report_line_number</pre> | <pre>filter #include:     project.h     report.h  Public Definitions:     clear_data()     filter_data()  Uses:     report_error()</pre> | <pre>report #include:     project.h  Public Definitions:     report_data_line()     report_line_number     report_error()</pre> |
|--|--|---|

### Compilation Files:

|             |   |
|-------------|---|
| *.o         | Relocatable object file that is generated by each unit. |
| *.err       | Error file that is generated by each unit.              |
| *.osym      | Unit symbol file that is generated by each unit.        |
| project.hex | Final load image file generated by the project.         |
| project.lst | C and ASM listing file generated by the project.        |
| project.sym | Project symbols file generated by the project.          |
| project.cof | Debugger file generated by the project.                 |

Using Command-Line to Build a Project:

Move all of the source files for the project into a single directory.

Using a text editor, create the file *buildall.bat*, based off of the following example in order to compile the files and build the project.

- The path should point to the *CCSC.exe* file in the PIC-C installation directory.
- Add any additional compiler options.
- Use the *EXPORT* option to include the necessary \*.c files.
- Use the *LINK* option to generate a \*.hex file.

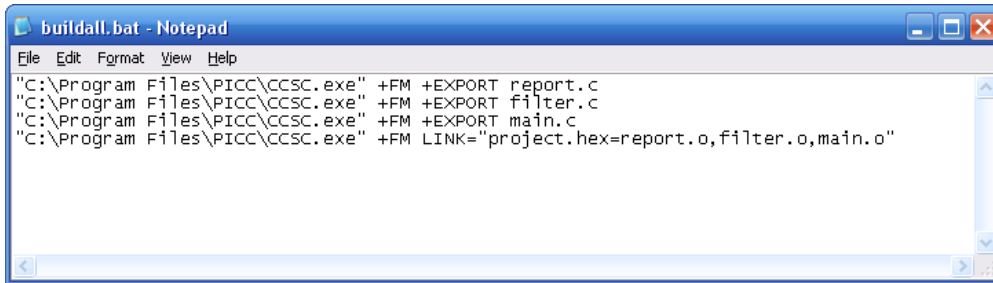

```

"C:\Program Files\PICC\CCSC.exe" +FM +EXPORT report.c
"C:\Program Files\PICC\CCSC.exe" +FM +EXPORT filter.c
"C:\Program Files\PICC\CCSC.exe" +FM +EXPORT main.c
"C:\Program Files\PICC\CCSC.exe" +FM LINK="project.hex=report.o,filter.o,main.o"

```

Double-click on the *builddall.bat* file created earlier or use a command prompt by changing the default directory to the project directory. Then use the command BUILDALL to build the project using all of the files.

Using Command Line to Re-Build Changed Files in a Project:

Using a text editor, create the file *project.pjt* based off of the following example in order to include the files that need to be linked for the project.

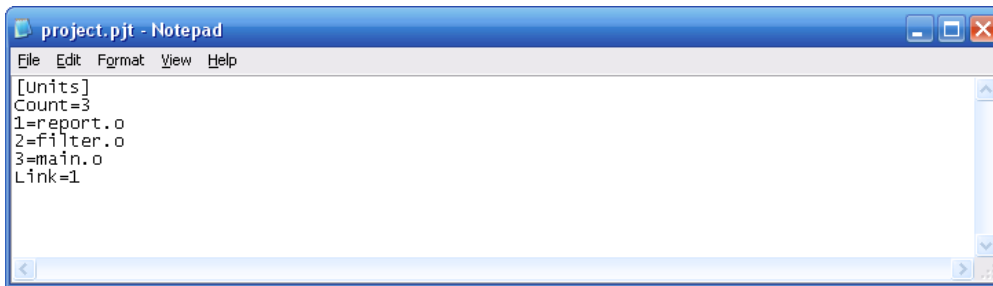

```

[units]
Count=3
1=report.o
2=filter.o
3=main.o
Link=1

```

Using a text editor, create the file *build.bat* based off of the following example in order to compile only the files that changed and re-build the project.

- The path should point to the CCSC.exe file in the PIC-C installation directory.
- Add any additional compiler options.
- Use the BUILD option to specify the \*.pjt file.

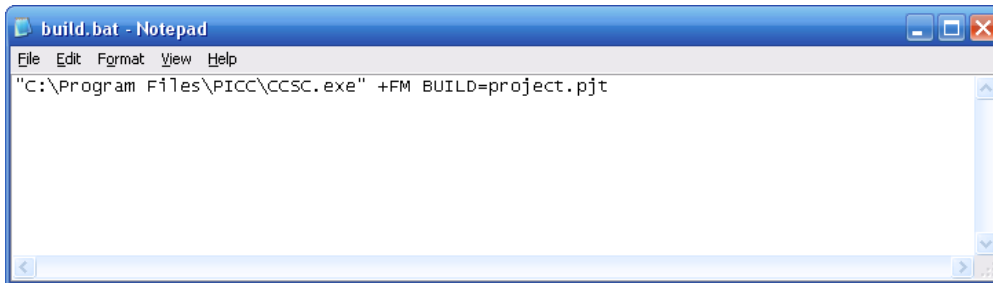

```

"C:\Program Files\PICC\CCSC.exe" +FM BUILD=project.pjt

```

## TEST PCD

Double-click on the *build.bat* file created earlier or use a command prompt by changing the default directory to the project directory and then use the command BUILD to re-build the project using only the necessary files that changed.

### Using a Linker Script:

Using a text editor, create the file *project.c* based off of the following example in order to include the files that need to be linked for the project.

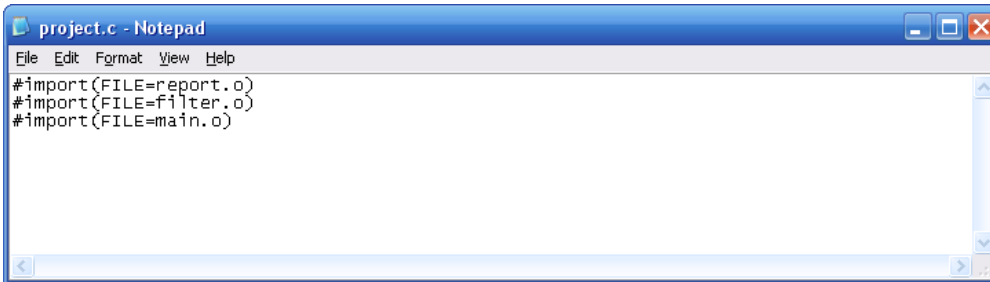

```
project.c - Notepad
File Edit Format View Help
#import(FILE=report.o)
#import(FILE=filter.o)
#import(FILE=main.o)
```

Using a text editor, create the file *linker.bat* based off of the following example in order to compile the files and build the project.

- The path should point to the CCSC.exe file in the PIC-C installation directory.
- Add any additional compiler options.
- Use the EXPORT option to include the necessary \*.c files.
- The LINK option is replaced with the \*.c file containing the #import commands.

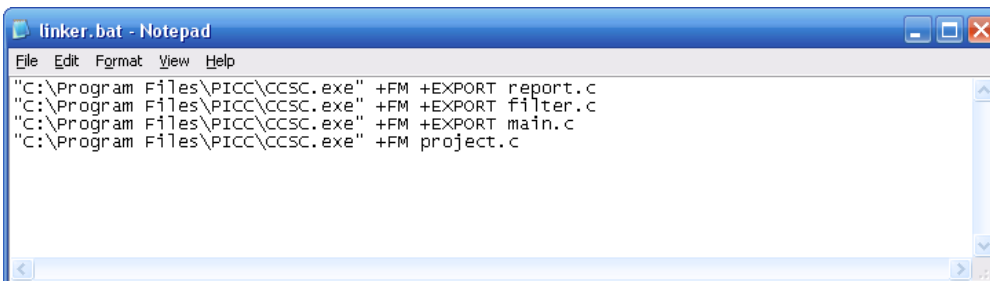

```
linker.bat - Notepad
File Edit Format View Help
"C:\Program Files\PICC\CCSC.exe" +FM +EXPORT report.c
"C:\Program Files\PICC\CCSC.exe" +FM +EXPORT filter.c
"C:\Program Files\PICC\CCSC.exe" +FM +EXPORT main.c
"C:\Program Files\PICC\CCSC.exe" +FM project.c
```

Double-click on the *linker.bat* file created earlier or use a command prompt by changing the default directory to the project directory and then use the command LINKER to build the project using all of the files.

### Using the CCS PCW IDE with Multiple Compilation Units:

Open the PCW IDE and select the *Project* tab in the ribbon along the top of the main window or in the menu bar if the IDE view style has been changed, then select the *Create* option. A window will be displayed asking to select the main source file of the project.



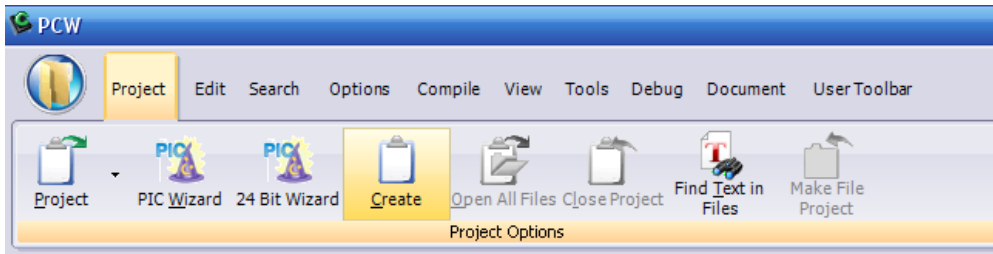

After selecting the main source file the *Project Options* window will appear. In this window, select the type of chip being used in the project. Then, check the boxes next to the *Multiple Compilation Units* and *Link Separately* options. This will allow additional source files to be added. Click the *Add* button and select the other source files used in the project to add them to the list. Click the *Apply* button to create the project.

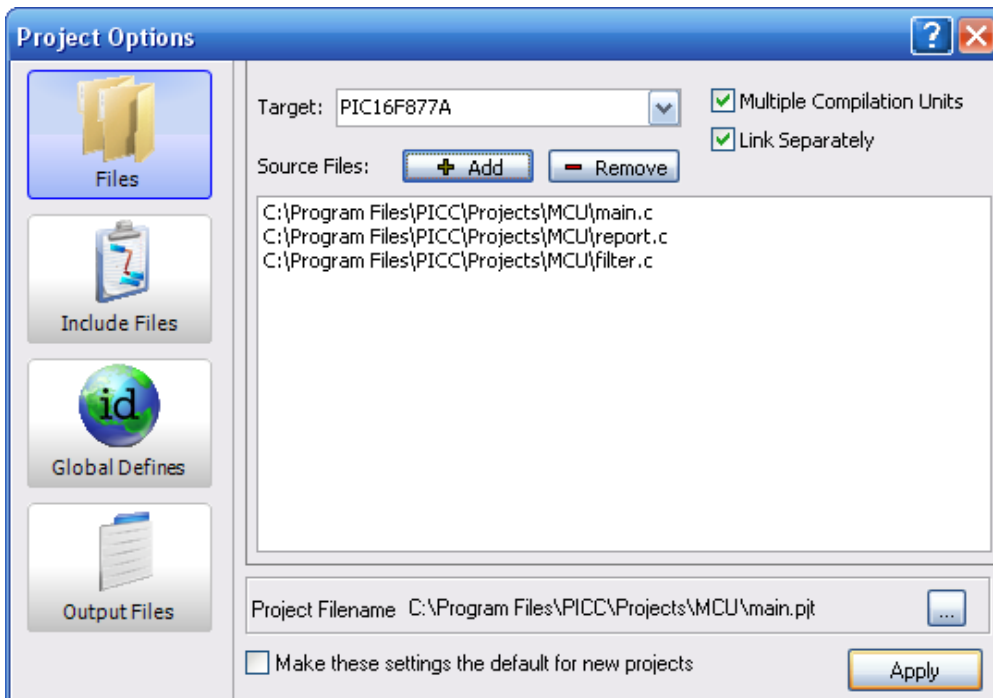

To compile the files in a project and build the project itself, select either the *Compile* tab in the ribbon along the top of the main window, in the menu bar if the IDE view style has been changed, or right-click on the files in the *Files* pane along the left side of the editor window.

- *Compile*: Compiles all the units in the current project or a single unit selected from the drop-down menu.
- *Build*: Compiles units that have changed since the last compile and rebuilds the project.

## TEST PCD

- Build All: Compiles all the units and builds the project.
- Clean: Deletes the output files for the project.

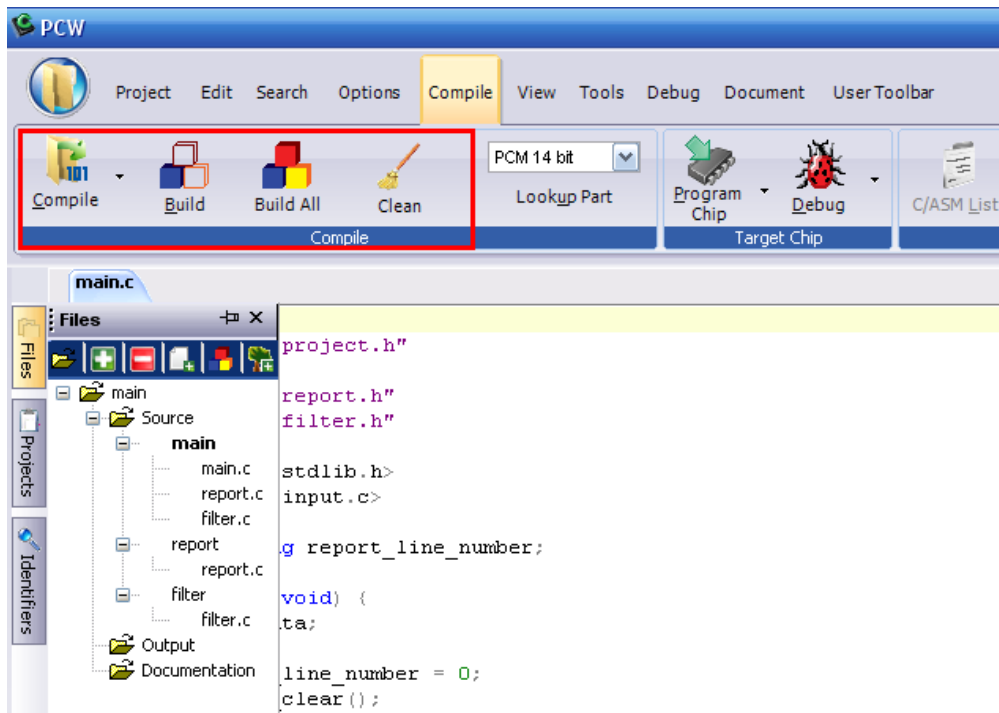

After a file has been compiled, the files used during the compilation will appear under the unit's name in the *Files* pane.

### Using the MPLAB IDE with Multiple Compilation Units:

Open the MPLAB IDE, select the *Project* tab in the menu bar and select the *New* option. A window will be displayed asking to select the main source file of the project.

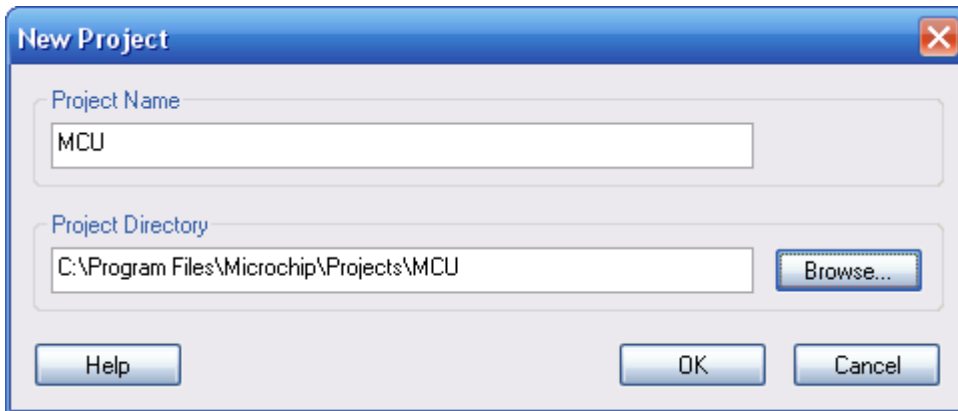

Select the *Project* tab in the menu bar and select the *Select Language Toolsuite* option. A window will be displayed, select the *CCS C Compiler* from the drop-down list in the *Active Toolsuite* field. Make sure the correct directory location is displayed for the compiler.

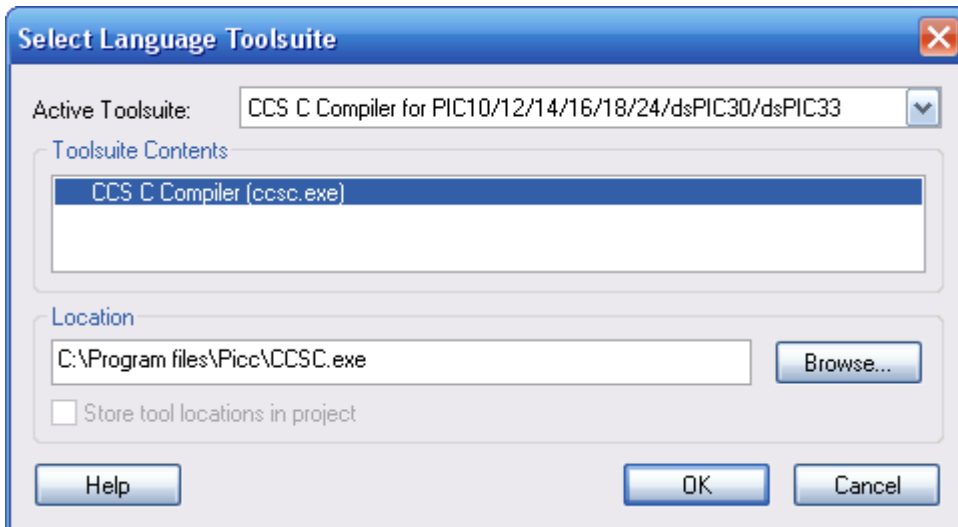

Select the *Configure* tab in the menu bar and select the *Select Device* option. A window will be displayed, select the correct PIC from the list provided.

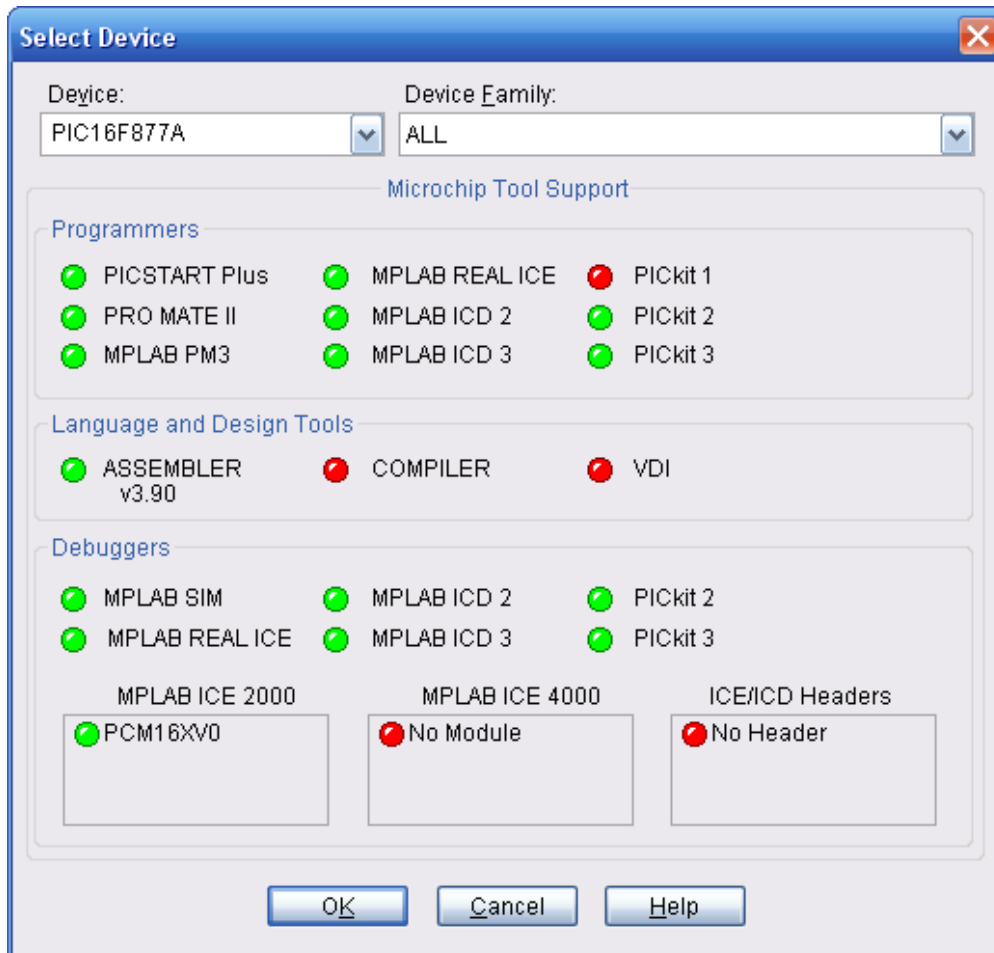

Add source files to the project by either selecting the *Project* tab in the menu bar and then the *Add File to Project* option or by right-clicking on the *Source Files* folder in the project window and selecting *Add Files*. A window will be displayed, select the source files to add to the project.

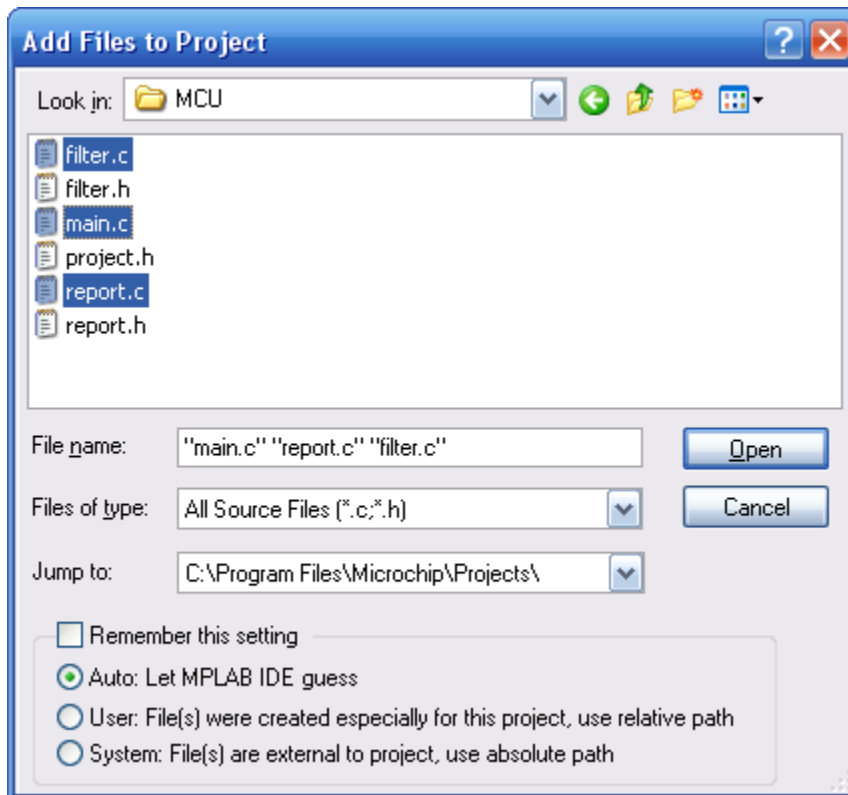

Select the *Project* tab in the menu bar and select *Build Options*. This will allow changes to be made to the output directory, include directories, output files generated, etc for the entire project or just individual units.

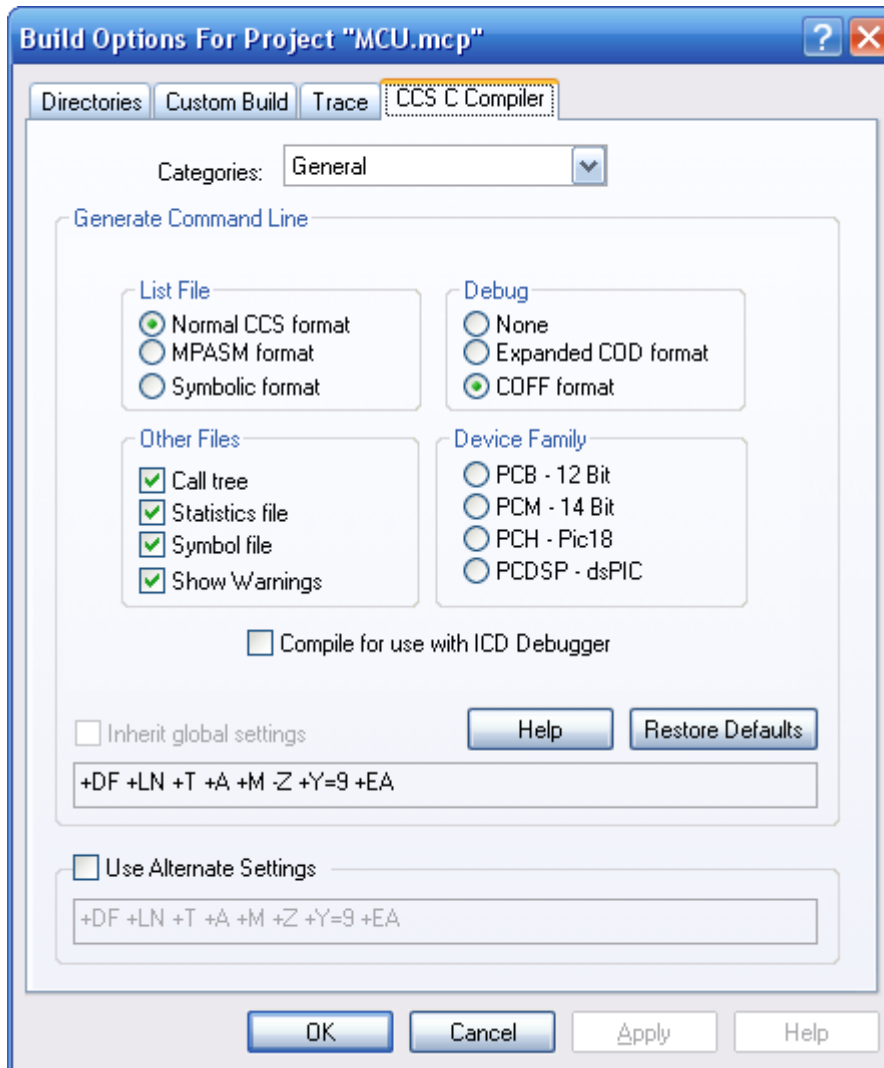

To compile the files in a project and build the project itself, select either the *Project* tab in the menu bar or right-click on the files in the Project window.

- Compile: Compiles the selected unit and will not re-link the project after compilation.
- Make: Compiles units that have changed since the last compile and rebuilds the project.
- Build All: Compiles all the units, deletes intermediate files, and builds the project.
- Clean: Deletes the output files for the project.

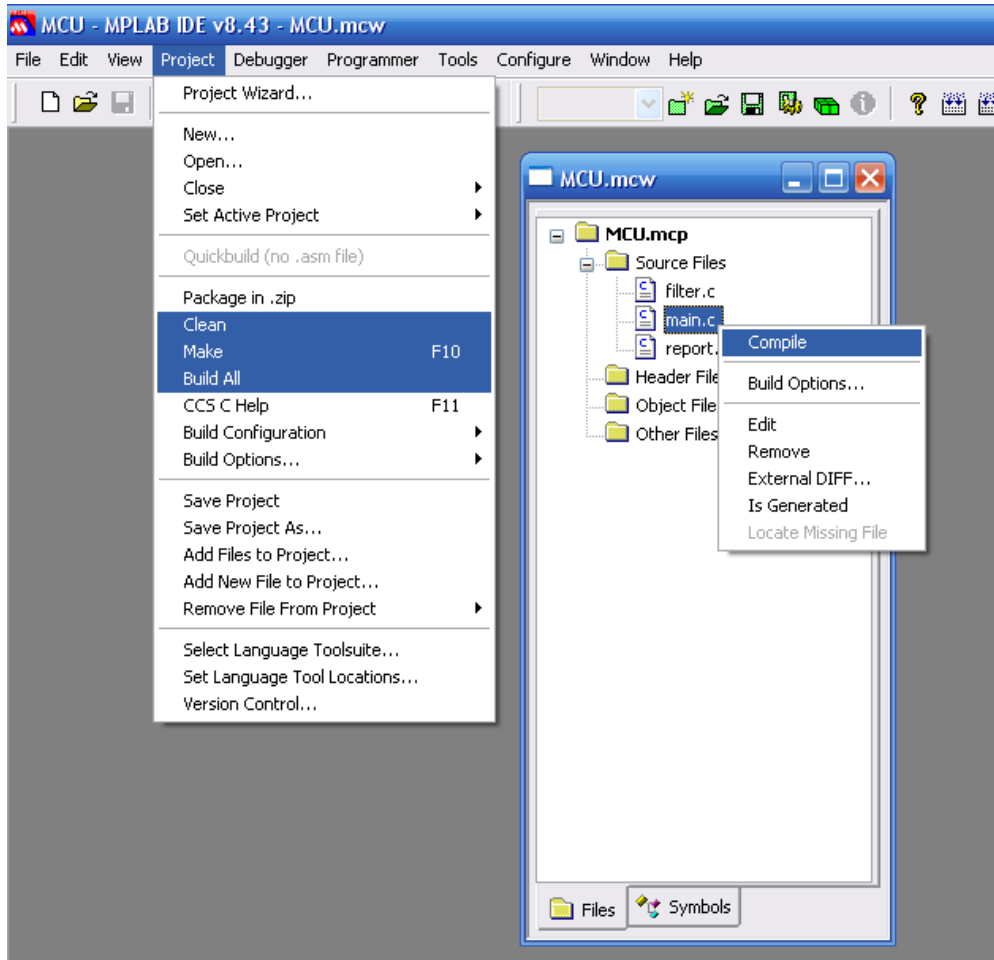

Additional Note: If there is only one source file in the project, it will be compiled and linked in one step, a \*.o file will not be created. A \*.o file, that has already been compiled can be added to the project and linked during the make / build process.

**Additional Notes:**

To make a variable or function private to a single unit, use the keyword `static`. By default, variables declared outside a function at the unit level are visible to all other units in the project. If the `static` keyword is used on a function or variable that is accessed outside of the local unit, a link time error will occur.

If two units have a function or a unit level variable of the same name, an error will occur unless one of the following conditions is true:

- The identifier is qualified with the keyword `static`.

## TEST PCD

- The argument list is different for both functions, allowing them to co-exist according to normal overload rules.
- The contents of the functions are identical, such as when the same \*.h file is included in multiple files, then the linker will delete the duplicate functions.

For a project with multiple compilation units, it is best to include a file such as *project.h* which includes the #includes, #defines, pre-processor directives, and any other compiler settings that are the same for all the units in a project.

When a setting such as a pre-processor directive is included in the main include file between the units, a library is created in each of the units. The linker is able to determine that the libraries are duplicates and removes them during the final linking process.

When building a project, each unit being used in the project has its own error file. When using a \*.bat file to do the unit compilations, it may be useful to terminate the process on the first error. Using the +CC command option, the compiler will return an error code if the compilation fails.

## Example

Here is a sample program with explanation using CCS C to read adc samples over rs232:

```
////////////////////////////////////  
// This program displays the min and max of 30, //  
// comments that explains what the program does, //  
// and A/D samples over the RS-232 interface. //  
////////////////////////////////////  
  
#if defined(__PCM__)  
    // preprocessor directive that chooses the compiler  
#include <16F877.h>  
    // preprocessor directive that selects the chip PIC16F877  
#fuses HS,NOWDT,NOPROTECT,NOLVP  
    // preprocessor directive that defines fuses for the chip  
  
#use delay(clock=20000000)  
    // preprocessor directive that specifies the clock speed  
#use rs232(baud=9600, xmit=PIN_C6, rcv=PIN_C7)  
    // preprocessor directive that includes the rs232 libraries  
#elif defined(__PCH__)  
    // same as above but for the PCH compiler and PIC18F452  
#include <18F452.h>  
#fuses HS,NOWDT,NOPROTECT,NOLVP  
#use delay(clock=20000000)  
#use rs232(baud=9600, xmit=PIN_C6, rcv=PIN_C7)  
#endif  
void main() { // main function  
    int i, value, min, max; // local variable declaration  
    printf("Sampling:");  
    // printf function included in the RS232 library
```



```

    setup_port_a( ALL_ANALOG );           // A/D setup functions- built-
in
    setup_adc( ADC_CLOCK_INTERNAL );     // A/D setup functions- built-
in
    set_adc_channel( 0 );                // A/D setup functions- built-
in
    do {                                  // do while statement
        min=255;                          // expression
        max=0;
        for(i=0; i<=30; ++i) {           // for statement
            delay_ms(100);                // delay built-in function
call
            value = Read_ADC();           // A/D read functions- built-
in
            if(value<min)                  // if statement
                min=value;
            if(value>max)                  // if statement
                max=value;
        }
        printf("\n\rMin: %2X  Max: %2X\n\r",min,max);
    } while (TRUE);
}

```



# STATEMENTS



## Statements

| STATEMENT  |  |
|--|--|
| <a href="#">if</a> (expr) stmt; [else stmt;]   | <pre>if (x==25) x=1; else x=x+1;</pre>   |
| <a href="#">while</a> (expr) stmt;   | <pre>while (get_rtcc() !=0) putc('n');</pre>   |
| <a href="#">do</a> stmt while (expr);  | <pre>do { putc(c=getc()); } while (c!=0);</pre>  |
| <a href="#">for</a> (expr1;expr2;expr3) stmt;  | <pre>for (i=1;i&lt;=10;++i) printf("%u\r\n",i);</pre>  |
| <a href="#">switch</a> (expr) {<br>case cexpr: stmt; //one or more case<br>[default:stmt]<br>... } | <pre>switch (cmd) { case 0: printf("cmd 0"); break; case 1: printf("cmd 1"); break; default: printf("bad cmd"); break; }</pre> |
| <a href="#">return</a> [expr];   | <pre>return (5);</pre>   |
| <a href="#">goto</a> label;  | <pre>goto loop;</pre>  |
| <a href="#">label</a> : stmt;  | <pre>loop: I++;</pre>  |
| <a href="#">break</a> ;  | <pre>break;</pre>  |
| <a href="#">continue</a> ;   | <pre>continue;</pre>   |
| <a href="#">expr</a> ;   | <pre>i=1;</pre>  |
| <a href="#">i</a>  | <pre>;</pre>   |
| { <a href="#">stmt</a> }   | <pre>{a=1; b=1;}</pre>   |
| Zero or more   |  |

Note: Items in [ ] are optional

## if

### if-else

The if-else statement is used to make decisions.

The syntax is:

```
if (expr)
    stmt-1;
[else
    stmt-2;]
```

The expression is evaluated; if it is true stmt-1 is done. If it is false then stmt-2 is done.

### else-if

This is used to make multi-way decisions.

The syntax is:

```
if (expr)
    stmt;
[else if (expr)
    stmt;]
...
[else
    stmt;]
```

The expression's are evaluated in order; if any expression is true, the statement associated with it is executed and it terminates the chain. If none of the conditions are satisfied the last else part is executed.

Example:

```
if (x==25)
    x=1;
else
    x=x+1;
```

Also See: [Statements](#)

## while

While is used as a loop/iteration statement.

The syntax is

```
while (expr)
    statement
```

The expression is evaluated and the statement is executed until it becomes false in which case the execution continues after the statement.

Example:

```
while (get_rtcc()!=0)
    putc('\n');
```

Also See: [Statements](#)

## do

Statement: **do** stmt **while** (expr);

Example:

```
do {
    putchar(c=getc());
} while (c!=0);
```

Also See: [Statements](#) , [While](#)

## do-while

It differs from While and For loop in that the termination condition is checked at the bottom of the loop rather than at the top and so the body of the loop is always executed at least once. The syntax is

```
do
    statement
while (expr);
```

The statement is executed; the expr is evaluated. If true, the same is repeated and when it becomes false the loop terminates.

Also See: [Statements](#) , [While](#)

## for

For is also used as a loop/iteration statement.  
The syntax is

```
for (expr1;expr2;expr3)
    statement
```

The expressions are loop control statements. expr1 is the initialization, expr2 is the termination check and expr3 is re-initialization. Any of them can be omitted.

Example:

```
for (i=1;i<=10;++i)
    printf("%u\r\n",i);
```

Also See: [Statements](#)

## switch

Switch is also a special multi-way decision maker. The syntax is

```
switch (expr) {  
    case const1: stmt sequence;  
                break;  
  
    ...  
    [default:stmt]  
}
```

This tests whether the expression matches one of the constant values and branches accordingly. If none of the cases are satisfied the default case is executed. The break causes an immediate exit, otherwise control falls through to the next case.

Example:

```
switch (cmd) {  
    case 0:printf("cmd 0");  
           break;  
    case 1:printf("cmd 1");  
           break;  
    default:printf("bad cmd");  
            break; }
```

Also See: [Statements](#)

## return

Statement: return [expr];

A return statement allows an immediate exit from a switch or a loop or function and also returns a value.

The syntax is  
return(expr);

Example:

```
return (5);
```

Also See: [Statements](#)

## goto

Statement: **goto** label;

The goto statement cause an unconditional branch to the label.

The syntax is

```
goto label;
```

A label has the same form as a variable name, and is followed by a colon. The goto's are used sparingly, if at all.

Example:

```
goto loop;
```

Also See: [Statements](#)

## label

Statement: label: stmt;

Example:

```
loop: i++;
```

Also See: [Statements](#)

## break

Statement: **break**;

The break statement is used to exit out of a control loop. It provides an early exit from while, for ,do and switch.

The syntax is

```
break;
```

It causes the innermost enclosing loop(or switch) to be exited immediately.

Example:

```
break;
```

Also See: [Statements](#)

## continue

Statement: **continue**;

The continue statement causes the next iteration of the enclosing loop(While, For, Do) to begin.

The syntax is

```
continue;
```

It causes the test part to be executed immediately in case of do and while and the control passes the re-initialization step in case of for.

Example:

```
continue;
```

Also See: [Statements](#)

## expr

Statement: expr;

Example:

```
i=1;
```

Also See: [Statements](#)

;

Statement: ;

Example:

```
;
```

Also See: [Statements](#)

## stmt

Statement: **{[stmt]}**

Zero or more semi colon separated

Example:

```
{ a=1;  
  b=1; }
```

Also See: [Statements](#)



# EXPRESSIONS



## Expressions

| Constants: |   |
|------------|---|
| 123        | Decimal   |
| 0123       | Octal   |
| 0x123      | Hex   |
| 0b010010   | Binary  |
| 'x'        | Character   |
| '\010'     | Octal Character   |
| '\xA5'     | Hex Character   |
| '\c'       | Special Character. Where c is one of:<br>\n Line Feed - Same as \x0a<br>\r Return Feed - Same as \x0d<br>\t TAB - Same as \x09<br>\b Backspace - Same as \x08<br>\f Form Feed - Same as \x0c<br>\a Bell - Same as \x07<br>\v Vertical Space - Same as \x0b<br>\? Question Mark - Same as \x3f<br>\' Single Quote - Same as \x22<br>\" Double Quote - Same as \x22<br>\\ A Single Backslash - Same as \x5c |
| "abcdef"   | String (null is added to the end)   |

| Identifiers: |   |
|--------------|---|
| ABCDE        | Up to 32 characters beginning with a non-numeric. Valid characters are A-Z, 0-9 and _ (underscore). |
| ID[X]        | Single Subscript  |
| ID[X][X]     | Multiple Subscripts   |
| ID.ID        | Structure or union reference  |
| ID-          | Structure or union reference  |
| >ID          |   |

## Operators

|     |   |
|-----|---|
| +   | Addition Operator   |
| +=  | Addition assignment operator, $x+=y$ , is the same as $x=x+y$             |
| &=  | Bitwise and assignment operator, $x&=y$ , is the same as $x=x&y$          |
| &   | Address operator  |
| &   | Bitwise and operator  |
| ^=  | Bitwise exclusive or assignment operator, $x^=y$ , is the same as $x=x^y$ |
| ^   | Bitwise exclusive or operator   |
| =   | Bitwise inclusive or assignment operator, $x =y$ , is the same as $x=x y$ |
|     | Bitwise inclusive or operator   |
| ?:  | Conditional Expression operator   |
| --  | Decrement   |
| /=  | Division assignment operator, $x/=y$ , is the same as $x=x/y$             |
| /   | Division operator   |
| ==  | Equality  |
| >   | Greater than operator   |
| >=  | Greater than or equal to operator   |
| ++  | Increment   |
| *   | Indirection operator  |
| !=  | Inequality  |
| <<= | Left shift assignment operator, $x<<=y$ , is the same as $x=x<<y$         |
| <   | Less than operator  |
| <<  | Left Shift operator   |
| <=  | Less than or equal to operator  |
| &&  | Logical AND operator  |
| !   | Logical negation operator   |
|     | Logical OR operator   |
| %=  | Modules assignment operator $x%=y$ , is the same as $x=x%y$               |

|        |   |
|--------|---|
| %      | Modules operator  |
| *=     | Multiplication assignment operator, $x*=y$ , is the same as $x=x*y$ |
| *      | Multiplication operator   |
| ~      | One's complement operator   |
| >>=    | Right shift assignment, $x>>=y$ , is the same as $x=x>>y$           |
| >>     | Right shift operator  |
| ->     | Structure Pointer operation   |
| -=     | Subtraction assignment operator                                     |
| -      | Subtraction operator  |
| sizeof | Determines size in bytes of operand                                 |

## Operator Precedence

| PIN DESCENDING PRECEDENCE |               |               |              |
|---------------------------|---------------|---------------|--------------|
| (expr)                    |               |               |              |
| ++expr                    | expr++        | - -expr       | expr - -     |
| !expr                     | ~expr         | +expr         | -expr        |
| (type)expr                | *expr         | &value        | sizeof(type) |
| expr*expr                 | expr/expr     | expr%expr     |              |
| expr+expr                 | expr-expr     |               |              |
| expr<<expr                | expr>>expr    |               |              |
| expr<expr                 | expr<=expr    | expr>expr     | expr>=expr   |
| expr==expr                | expr!=expr    |               |              |
| expr&expr                 |               |               |              |
| expr^expr                 |               |               |              |
| expr   expr               |               |               |              |
| expr&& expr               |               |               |              |
| expr    expr              |               |               |              |
| expr ? expr: expr         |               |               |              |
| lvalue = expr             | lvalue+=expr  | lvalue-=expr  |              |
| lvalue *=expr             | lvalue/=expr  | lvalue%=expr  |              |
| lvalue>>=expr             | lvalue<<=expr | lvalue &=expr |              |
| lvalue ^=expr             | lvalue =expr  |               |              |
| expr, expr                |               |               |              |

(Operators on the same line are equal in precedence)

## Reference Parameters

The compiler has limited support for reference parameters. This increases the readability of code and the efficiency of some inline procedures. The following two procedures are the same. The one with reference parameters will be implemented with greater efficiency when it is inline.

```

funcnt_a(int*x,int*y){
    /*Traditional*/
    if(*x!=5)
        *y=*x+3;
}

```

```

funcnt_a(&a, &b);

```

```

funcnt_b(int&x,int&y){
    /*Reference params*/
    if(x!=5)
        y=x+3;
}

```

```

funcnt_b(a,b);

```

## Variable Argument Lists

The compiler supports a variable number of parameters. This works like the ANSI requirements except that it does not require at least one fixed parameter as ANSI does. The function can be passed any number of variables and any data types. The access functions are VA\_START, VA\_ARG, and VA\_END. To view the number of arguments passed, the NARGS function can be used.

```

/*
stdarg.h holds the macros and va_list data type needed for variable
number of parameters.
*/
#include <stdarg.h>

```

A function with variable number of parameters requires two things. First, it requires the ellipsis (...), which must be the last parameter of the function. The ellipsis represents the variable argument list. Second, it requires one more variable before the ellipsis (...). Usually you will use this variable as a method for determining how many variables have been pushed onto the ellipsis.

Here is a function that calculates and returns the sum of all variables:

```
int Sum(int count, ...)
{
    //a pointer to the argument list
    va_list al;
    int x, sum=0;
    //start the argument list
    //count is the first variable before the ellipsis
    va_start(al, count);
    while(count-->0) {
        //get an int from the list
        x = var_arg(al, int);
        sum += x;
    }
    //stop using the list
    va_end(al);
    return(sum);
}
```

Some examples of using this new function:

```
x=Sum(5, 10, 20, 30, 40, 50);
y=Sum(3, a, b, c);
```

## Default Parameters

Default parameters allows a function to have default values if nothing is passed to it when called.

```
int mygetc(char *c, int n=100){
}
```

This function waits n milliseconds for a character over RS232. If a character is received, it saves it to the pointer c and returns TRUE. If there was a timeout it returns FALSE.

```
//gets a char, waits 100ms for timeout
mygetc(&c);
//gets a char, waits 200ms for a timeout
mygetc(&c, 200);
```

## Overloaded Functions

Overloaded functions allow the user to have multiple functions with the same name, but they must accept different parameters. The return types must remain the same.

Here is an example of function overloading: Two functions have the same name but differ in the types of parameters. The compiler determines which data type is being passed as a parameter and calls the proper function.

## TEST PCD

This function finds the square root of a long integer variable.

```
long FindSquareRoot(long n){  
}
```

This function finds the square root of a float variable.

```
float FindSquareRoot(float n){  
}
```

FindSquareRoot is now called. If variable is of long type, it will call the first FindSquareRoot() example. If variable is of float type, it will call the second FindSquareRoot() example.

```
result=FindSquareRoot(variable);
```

# DATA DEFINITIONS



## Basic and Special types

This section describes what the basic data types and specifiers are and how variables can be declared using those types. In C all the variables should be declared before they are used. They can be defined inside a function (local) or outside all functions (global). This will affect the visibility and life of the variables.

### Basic Types

| Type-Specifier | Size                            | Range   |   | Digits |
|----------------|---------------------------------|---|---|--------|
|                |                                 | Unsigned  | Signed                                      |        |
| <b>int1</b>    | 1 bit number                    | 0 to 1  | N/A   | 1/2    |
| <b>int8</b>    | 8 bit number                    | 0 to 255  | -128 to 127                                 | 2-3    |
| <b>int16</b>   | 16 bit number                   | 0 to 65535  | -32768 to 32767                             | 4-5    |
| <b>int32</b>   | 32 bit number                   | 0 to 4294967295                                     | -2147483648 to 2147483647                   | 9-10   |
| <b>int48</b>   | 48 bit number                   | 0 to 281474976710655                                | -140737488355328 to 140737488355327         | 14-15  |
| <b>int64</b>   | 64 bit number                   | N/A   | -9223372036854775808 to 9223372036854775807 | 18-19  |
| <b>float32</b> | 32 bit float                    | -1.5 x 10 <sup>45</sup> to 3.4 x 10 <sup>38</sup>   |   | 7-8    |
| <b>float48</b> | 48 bit float (higher precision) | -2.9 x 10 <sup>39</sup> to 1.7 x 10 <sup>38</sup>   |   | 11-12  |
| <b>float64</b> | 64 bit float                    | -5.0 x 10 <sup>324</sup> to 1.7 x 10 <sup>308</sup> |   | 15-16  |

| C Standard Type |     | Default Type  |
|-----------------|-----|---------------|
| short           |     | int8          |
| char            |     | unsigned int8 |
| int             |     | int16         |
| long            |     | int32         |
| long long       |     | int64         |
| float           |     | float32       |
| double          | N/A | float64       |

Note: All types, except char, by default are signed; however, may be preceded by unsigned or signed (Except int64 may only be signed). Short and long may have the keyword INT following them with no effect. Also see #TYPE to change the default size. INT1 is a special type used to generate very efficient code for bit operations and I/O. Arrays of bits (INT1 or SHORT) in RAM are now supported. Pointers to bits are not permitted. The device header files contain defines for BYTE as an int8 and BOOLEAN as an int1. Integers are stored in little endian format. The LSB is in the lowest address. Float formats are described in common questions.

**Type-Qualifier**

|                  |  |
|------------------|--|
| <b>static</b>    | Variable is globally active and initialized to 0. Only accessible from this compilation unit.  |
| <b>auto</b>      | Variable exists only while the procedure is active. This is the default and AUTO need not be used.   |
| <b>extern</b>    | External variable used with multiple compilation units. No storage is allocated. Is used to make otherwise out of scope data accessible. there must be a non-extern definition at the global level in some compilation unit. |
| <b>register</b>  | If possible a CPU register instead of a RAM location.  |
| <b>_fixed(n)</b> | Creates a fixed point decimal number where <i>n</i> is how many decimal places to implement.   |
| <b>unsigned</b>  | Data is always positive.   |
| <b>signed</b>    | Data can be negative or positive. This is the default data type if not specified.  |
| <b>volatile</b>  | Tells the compiler optimizer that this variable can be changed at any point during execution.  |
| <b>const</b>     | Data is read-only. Depending on compiler configuration, this qualifier may just make the data read-only -AND/OR- it may place the data into program memory to save space. (see #DEVICE const=)                               |
| <b>void</b>      | Built-in basic type. Type void is used to indicate no specific type in places where a type is required.  |
| <b>_readonly</b> | writes to this variable should be dis-allowed  |

**Special types**

**Enum** enumeration type: creates a list of integer constants.

```
enum      [id]                { [ id [= cexpr]] }
                                One or more comma separated
```

The id after **ENUM** is created as a type large enough to the largest constant in the list. The ids in the list are each created as a constant. By default the first id is set to zero and they increment by one. If a = cexpr follows an id that id will have the value of the constant expression and the following list will increment by one.

For example:

```
enum colors{red, green=2, blue}; // red will be 0, green will be 2
                                // and blue will be 3
```



**Struct** structuretype: creates a collection of one or more variables, possibly of different types, grouped together as a single unit.

```
struct[*][id] { type-qualifier [*] id [:bits]; } [id]
```

|   |                 |
|---|-----------------|
| One or more,<br>semi-colon<br>separated | Zero<br>or more |
|---|-----------------|

For example:

```
struct data_record {
    int a [2];
    int b : 2; /*2 bits */
    int c : 3; /*3 bits*/
    int d;
} data_var; // data_record is a structure type
//data_var is a variable
```

#### Field Allocation

- Fields are allocated in the order they appear.
- The low bits of a byte are filled first.
- Fields 16 bits and up are aligned to an even byte boundary. Some Bits may be unused.
- No Field will span from an odd byte to an even byte unless the field width is a multiple of 16 bits.

**Union** union type: holds objects of different types and sizes, with the compiler keeping track of size and alignment requirements. They provide a way to manipulate different kinds of data in a single area of storage.

```
union[*][id] { type-qualifier [*] id [:bits]; } [id]
```

|   |                 |
|---|-----------------|
| One or more,<br>semi-colon<br>separated | Zero<br>or more |
|---|-----------------|

```
For example:
union u_tag {
    int ival;
    long lval;
    float fval;
}; // u_tag is a union type that can hold a float
```

If **typedef** is used with any of the basic or special types it creates a new type name that can be used in declarations. The identifier does not allocate space but rather may be used as a type specifier in other data definitions.

**typedef** [type-qualifier] [type-specifier] [declarator];

For example:

```
typedef int mybyte;           // mybyte can be used in declaration to
                             // specify the int type
typedef short mybit;        // mybyte can be used in declaration to
                             // specify the int type
typedef enum {red, green=2,blue}colors; //colors can be used to
declare
                             //variables of this enum type
```

**\_\_ADDRESS\_\_**: A predefined symbol **\_\_ADDRESS\_\_** may be used to indicate a type that must hold a program memory address.

For example:

```
__ADDRESS__ testa = 0x1000 //will allocate 16 bits for test a and
                           //initialize to 0x1000
```

## Declarations

A declaration specifies a type qualifier and a type specifier, and is followed by a list of one or more variables of that type.

For e.g.:

```
int a,b,c,d;
mybit e,f;
mybyte g[3][2];
char *h;
colors j;
struct data_record data[10];
static int i;
extern long j;
```

Variables can also be declared along with the definitions of the *special* types.

For eg:

```
enum colors{red, green=2,blue}i,j,k; // colors is the enum type and
                                     // i,j,k are variables of that type
```

## Non-RAM Data Definitions

CCS C compiler also provides a custom qualifier `addressmod` which can be used to define a memory region that can be RAM, program eeprom, data eeprom or external memory. `Addressmod` replaces the older `typemod` (with a different syntax).

The usage is :

```
addressmod (name, read_function, write_function, start_address, end_address);
```

Where the `read_function` and `write_function` should be blank for RAM, or for other memory should be the following prototype:

```

// read procedure for reading n bytes from
// the memory starting at location addr
void read_function(int32 addr,int8 *ram, int nbytes){
}
//write procedure for writing n bytes to the
//memory starting at location addr
void write_function(int32 addr,int8 *ram, int nbytes){
}

```

**Example:**

```

void DataEE_Read(int32 addr, int8 * ram, int bytes) {
    int i;
    for(i=0;i<bytes;i++,ram++,addr++)
        *ram=read_eeeprom(addr);
}
void DataEE_Write(int32 addr, int8 * ram, int bytes) {
    int i;
    for(i=0;i<bytes;i++,ram++,addr++)
        write_eeeprom(addr,*ram);
}
addressmod (DataEE,DataEE_read,DataEE_write,5,0xff);
// would define a region called DataEE between
// 0x5 and 0xff in the chip data EEPROM.
void main (void)
{
    int DataEE test;
    int x,y;
    x=12;
    test=x; // writes x to the Data EEPROM
    y=test; // Reads the Data EEPROM
}

```

**Note:** If the area is defined in RAM then read and write functions are not required, the variables assigned in the memory region defined by the addressmod can be treated as a regular variable in all valid expressions. Any structure or data type can be used with an addressmod. Pointers can also be made to an addressmod data type. The #type directive can be used to make this memory region as default for variable allocations.

**The syntax is :**

```

#type default=addressmodname // all the variable declarations that
// follow will use this memory region
#type default= // goes back to the default mode

```

**For example:**

```

Type default=emi //emi is the addressmod name defined
char buffer[8192];
#include <memoryhog.h>
#type default=

```

## Using Program Memory for Data

CCS C Compiler provides a few different ways to use program memory for data. The different ways are discussed below:

### Constant Data:

The `CONST` qualifier will place the variables into program memory. If the keyword `CONST` is used before the identifier, the identifier is treated as a constant. Constants should be initialized and may not be changed at run-time. This is an easy way to create lookup tables.

The ROM Qualifier puts data in program memory with 3 bytes per instruction space. The address used for ROM data is not a physical address but rather a true byte address. The `&` operator can be used on ROM variables however the address is logical not physical.

The syntax is:

```
const type id[cexpr] = {value}
```

For example:

Placing data into ROM

```
const int table[16]={0,1,2...15}
```

Placing a string into ROM

```
const char cstring[6]={"hello"}
```

Creating pointers to constants

```
const char *cptr;
cptr = string;
```

The `#org` preprocessor can be used to place the constant to specified address blocks.

For example:

The constant ID will be at 1C00.

```
#ORG 0x1C00, 0x1C0F
CONST CHAR ID[10]= {"123456789"};
```

*Note:* Some extra code will precede the 123456789.

The function `label_address` can be used to get the address of the constant. The constant variable can be accessed in the code. This is a great way of storing constant data in large programs. Variable length constant strings can be stored into program memory.

A special method allows the use of pointers to ROM. This method does not contain extra code at the start of the structure as does constant.

For example:

```
char rom commands[] = {"put|get|status|shutdown"};
```

The compiler allows a non-standard C feature to implement a constant array of variable length strings.

The syntax is:

```
const char id[n] [*] = { "string", "string" ...};
```

Where `n` is optional and `id` is the table identifier.

For example:

```
const char colors[] [*] = {"Red", "Green", "Blue"};
```

#ROM directive:

Another method is to use #rom to assign data to program memory.

The syntax is:

```
#rom address = {data, data, ... , data}
```

For example:

Places 1,2,3,4 to ROM addresses starting at 0x1000

```
#rom 0x1000 = {1, 2, 3, 4}
```

Places null terminated string in ROM

```
#rom 0x1000={"hello"}
```

This method can only be used to initialize the program memory.

Built-in-Functions:

The compiler also provides built-in functions to place data in program memory, they are:

- 
- `write_program_memory(address, dataptr, count);`
  - Writes **count** bytes of data from **dataptr** to **address** in program memory.
  - Every fourth byte of data will not be written, fill with 0x00.

Please refer to the help of these functions to get more details on their usage and limitations regarding erase procedures. These functions can be used only on chips that allow writes to program memory. The compiler uses the flash memory erase and write routines to implement the functionality.

The data placed in program memory using the methods listed above can be read from with the following functions:

- `read_program_memory((address, dataptr, count)`
  - Reads count bytes from program memory at address to RAM at dataptr. Every fourth byte of data is read as 0x00
- `read_rom_memory((address, dataptr, count)`
  - Reads count bytes from program memory at the logical address to RAM at dataptr.

These functions can be used only on chips that allow reads from program memory. The compiler uses the flash memory read routines to implement the functionality.

## Function Definition

The format of a function definition is as follows:

[qualifier] id



Optional See Below

( [type-specifier id] )



Zero or more comma separated.  
See Data Types

{ [stmt] }



Zero or more Semi-colon separated. See Statements.

## TEST PCD

The qualifiers for a function are as follows:

- VOID
- type-specifier
- #separate
- #inline
- #int\_..

When one of the above are used and the function has a prototype (forward declaration of the function before it is defined) you must include the qualifier on both the prototype and function definition.

A (non-standard) feature has been added to the compiler to help get around the problems created by the fact that pointers cannot be created to constant strings. A function that has one CHAR parameter will accept a constant string where it is called. The compiler will generate a loop that will call the function once for each character in the string.

Example:

```
void lcd_putc(char c ) {  
    ...  
}  
  
lcd_putc ("Hi There.");
```

# FUNCTIONAL OVERVIEWS



## I2C

I2C™ is a popular two-wire communication protocol developed by Phillips. Many PIC microcontrollers support hardware-based I2C™. CCS offers support for the hardware-based I2C™ and a software-based master I2C™ device. (For more information on the hardware-based I2C module, please consult the datasheet for your target device; not all PICs support I2C™.)

### Relevant Functions:

|                                 |   |
|---------------------------------|---|
| <a href="#">i2c_start()</a>     | Issues a start command when in the I2C master mode.               |
| <a href="#">i2c_write(data)</a> | Sends a single byte over the I2C interface.                       |
| <a href="#">i2c_read()</a>      | Reads a byte over the I2C interface.                              |
| <a href="#">i2c_stop()</a>      | Issues a stop command when in the I2C master mode.                |
| <a href="#">i2c_poll()</a>      | Returns a TRUE if the hardware has received a byte in the buffer. |

### Relevant Preprocessor:

|                          |   |
|--------------------------|---|
| <a href="#">#USE I2C</a> | Configures the compiler to support I2C™ to your specifications. |
|--------------------------|---|

### Relevant Interrupts:

|                              |  |
|------------------------------|--|
| <a href="#">#INT_SSP</a>     | I2C or SPI activity                                  |
| <a href="#">#INT_BUSCOL</a>  | Bus Collision  |
| <a href="#">#INT_I2C</a>     | I2C Interrupt (Only on 14000)                        |
| <a href="#">#INT_BUSCOL2</a> | Bus Collision (Only supported on some PIC18's)       |
| <a href="#">#INT_SSP2</a>    | I2C or SPI activity (Only supported on some PIC18's) |
| <a href="#">#INT_mi2c</a>    | Interrupts on activity from the master I2C module    |
| <a href="#">#INT_si2c</a>    | Interrupts on activity from the slave I2C module     |

### Relevant Include Files:

None, all functions built-in

### Relevant getenv()

#### Parameters:

|                            |  |
|----------------------------|--|
| <a href="#">I2C_SLAVE</a>  | Returns a 1 if the device has I2C slave H/W    |
| <a href="#">I2C_MASTER</a> | Returns a 1 if the device has a I2C master H/W |

### Example Code:

```
#define Device_SDA PIN_C3 // Pin defines
#define Device_SLC PIN_C4
```

## TEST PCD

```
#use i2c(master,           // Configure Device as Master
sda=Device_SDA,
scl=Device_SCL)
..
..
BYTE data;               // Data to be transmitted
i2c_start();             // Issues a start command when in the I2C master mode.
i2c_write(data);        // Sends a single byte over the I2C interface.
i2c_stop();              //Issues a stop command when in the I2C master mode.
```

## ADC

These options let the user configure and use the analog to digital converter module. They are only available on devices with the ADC hardware. The options for the functions and directives vary depending on the chip and are listed in the device header file. On some devices there are two independent ADC modules, for these chips the second module is configured using secondary ADC setup functions (Ex. setup\_ADC2).

### Relevant Functions:

|  |  |
|--|--|
| setup_adc(mode)                                    | Sets up the a/d mode like off, the adc clock etc.  |
| setup_adc_ports(value)                             | Sets the available adc pins to be analog or digital.   |
| set_adc_channel(channel)                           | Specifies the channel to be use for the a/d call.  |
| read_adc(mode)                                     | Starts the conversion and reads the value. The mode can also control the functionality.                    |
| <a href="#">adc_done()</a>                         | Returns 1 if the ADC module has finished its conversion.   |
| <br>   |  |
| <a href="#">setup_adc2(mode)</a>                   | Sets up the ADC2 module, for example the ADC clock and ADC sample time.                                    |
| <a href="#">setup_adc_ports2(ports, reference)</a> | Sets the available ADC2 pins to be analog or digital, and sets the voltage reference for ADC2.             |
| <a href="#">set_adc_channel2(channel)</a>          | Specifies the channel to use for the ADC2 input.   |
| <a href="#">read_adc2(mode)</a>                    | Starts the sample and conversion sequence and reads the value The mode can also control the functionality. |
| <a href="#">adc_done()</a>                         | Returns 1 if the ADC module has finished its conversion  |

### Relevant Preprocessor:

|                                |  |
|--------------------------------|--|
| <a href="#">#DEVICE ADC=xx</a> | Configures the read_adc return size. For example, using a PIC with a 10 bit A/D you can use 8 or 10 for xx- 8 will return the most significant byte, 10 will return the full A/D reading of 10 bits. |
|--------------------------------|--|



Relevant Interrupts:

|          |   |
|----------|---|
| INT_AD   | Interrupt fires when a/d conversion is complete   |
| INT_ADOF | Interrupt fires when a/d conversion has timed out |

Relevant Include Files:

None, all functions built-in

Relevant getenv() parameters:

|                |                                     |
|----------------|-------------------------------------|
| ADC_CHANNELS   | Number of A/D channels              |
| ADC_RESOLUTION | Number of bits returned by read_adc |

Example Code:

```
#DEVICE ADC=10
...
long value;
...
setup_adc(ADC_CLOCK_INTERNAL); //enables the a/d module
                                //and sets the clock to internal adc clock
setup_adc_ports(ALL_ANALOG); //sets all the adc pins to analog
set_adc_channel(0);          //the next read_adc call will read channel 0
delay_us(10);                //a small delay is required after setting the channel
                                //and before read
value=read_adc();             //starts the conversion and reads the result
                                //and store it in value
read_adc(ADC_START_ONLY);    //only starts the conversion
value=read_adc(ADC_READ_ONLY); //reads the result of the last conversion and store it
                                //in value. Assuming the device hat a 10bit ADC
                                //module, value will range between 0-3FF. If
                                //DEVICE ADC=8 had been used instead the result
                                //will yield 0-FF. If #DEVICE ADC=16 had been used
                                //instead the result will yield 0-FFC0
```

## Analog Comparator

These functions sets up the analog comparator module. Only available in some devices.

Relevant Functions:

|                        |   |
|------------------------|---|
| setup_comparator(mode) | Enables and sets the analog comparator module. The options vary depending on the chip, please refer to the header file for details. |
|------------------------|---|

Relevant Preprocessor:

None

## TEST PCD

### Relevant Interrupts:

INT\_COMP

Interrupt fires on comparator detect. Some chips have more than one comparator unit, and hence more interrupts.

### Relevant Include Files:

None, all functions built-in

### Relevant getenv() parameters:

COMP

Returns 1 if the device has comparator

### Example Code:

```
setup_comparator(A4_A5_NC_NC);  
if(C1OUT)  
output_low(PIN_D0);  
else  
output_high(PIN_D1);
```

## CAN Bus

These functions allow easy access to the Controller Area Network (CAN) features included with the MCP2515 CAN interface chip and the PIC24, dsPIC30 and dsPIC33 MCUs. These functions will only work with the MCP2515 CAN interface chip and PIC microcontroller units containing either a CAN or an ECAN module. Some functions are only available for the ECAN module and are specified by the word ECAN at the end of the description. The listed interrupts are not available to the MCP2515 interface chip.

### Relevant Functions:

can\_init(void);

Initializes the module to 62.5k baud for ECAN and 125k baud for CAN and clears all the filters and masks so that all messages can be received from any ID.

can\_set\_baud(void);

Initializes the baud rate of the bus to 62.5kHz for ECAN and 125kHz for CAN. It is called inside the can\_init() function so there is no need to call it.

can\_set\_mode  
(CAN\_OP\_MODE mode);

Allows the mode of the CAN module to be changed to listen all mode, configuration mode, listen mode, loop back mode, disabled mode, or normal mode.

|   |   |
|---|---|
| <code>can_set_functional_mode</code><br>(CAN_FUN_OP_MODE mode);                           | Allows the functional mode of ECAN modules to be changed to legacy mode, enhanced legacy mode, or first in firstout (fifo) mode. ECAN             |
| <code>can_set_id</code> (int16 *addr, int32 id, int1 ext)                                 | Can be used to set the filter and mask ID's to the value specified by addr. It is also used to set the ID of the message to be sent on CAN chips. |
| <code>can_set_buffer_id</code> (BUFFER buffer, int32 id, int1 ext)                        | Can be used to set the ID of the message to be sent for ECAN chips. ECAN  |
| <code>can_get_id</code> (BUFFER buffer, int1 ext)   | Returns the ID of a received message.   |
| <code>can_putd</code> (int32 id, int8 *data, int8 len, int8 priority, int1 ext, int1 rtr) | Constructs a CAN packet using the given arguments and places it in one of the available transmit buffers.   |
| <code>can_getd</code> (int32 &id, int8 *data, int8 &len, struct rx_stat &stat)            | Retrieves a received message from one of the CAN buffers and stores the relevant data in the referenced function parameters.                      |
| <code>can_kbhit</code> ()   | Returns TRUE if valid CAN messages is available to be retrieved from one of the receive buffers.  |
| <code>can_tbe</code> ()   | Returns TRUE if a transmit buffer is available to send more data.   |
| <code>can_abort</code> ()   | Aborts all pending transmissions.   |
| <code>can_enable_b_transfer</code> (BUFFER b)   | Sets the specified programmable buffer to be a transmit buffer. ECAN  |
| <code>can_enable_b_receiver</code> (BUFFER b)   | Sets the specified programmable buffer to be a receive buffer. By default all programmable buffers are set to be receive buffers. ECAN            |
| <code>can_enable_rtr</code> (BUFFER b)  | Enables the automatic response feature which automatically sends a user created packet when a specified ID is received. ECAN                      |
| <code>can_disable_rtr</code> (BUFFER b)   | Disables the automatic response feature. ECAN   |
| <code>can_load_rtr</code> (BUFFER b, int8 *data, int8 len)                                | Creates and loads the packet that will automatically transmitted when the triggering ID is received. ECAN   |
| <code>can_set_buffer_size</code> (int8 size)  | Set the number of buffers to use. Size can be 4, 6, 8, 12, 16, 24, and 32. By default <code>can_init</code> () sets size to 32. ECAN              |
| <code>can_enable_filter</code><br>(CAN_FILTER_CONTROL filter)                             | Enables one of the acceptance filters included in the ECAN module. ECAN   |

## TEST PCD

|   |  |
|---|--|
| <code>can_disable_filter</code><br>(CAN_FILTER_CONTROL filter)  | Disables one of the acceptance filters included in the ECAN module. ECAN   |
| <code>can_associate_filter_to_buffer</code><br>(CAN_FILTER_ASSOCIATION_BUFFERS buffer, CAN_FILTER_ASSOCIATION filter) | Used to associate a filter to a specific buffer. This allows only specific buffers to be filtered and is available in the ECAN module. ECAN  |
| <code>can_associate_filter_to_mask</code><br>(CAN_MASK_FILTER_ASSOCIATION mask, CAN_FILTER_ASSOCIATION filter)        | Used to associate a mask to a specific buffer. This allows only specific buffer to have this mask applied. This feature is available in the ECAN module. ECAN  |
| <code>can_fifo_getd(int32 &amp;id, int8 *data, int8 &amp;len, struct rx_stat &amp;stat )</code>                       | Retrieves the next buffer in the FIFO buffer. Only available in the ECAN module. ECAN  |
| <code>can_trb0_putd(int32 id, int8 *data, int8 len, int8 pri, int1 ext, int1 rtr)</code>                              | Constructs a CAN packet using the given arguments and places it in transmit buffer 0. Similar functions available for all transmit buffers 0-7. Buffer must be made a transmit buffer with <code>can_enable_b_transfer()</code> function before function can be used. ECAN   |
| <code>can_enable_interrupts(INTERRUPT setting)</code>   | Enables specified interrupt conditions that cause the #INT_CAN1 interrupt to be triggered. Available options are:<br>TB - Transmitt Buffer Interrupt<br>ECAN<br>RB - Receive Buffer Interrupt<br>ECAN<br>RXOV - Receive Buffer Overflow Interrupt<br>ECAN<br>FIFO - FIFO Almost Full Interrupt<br>ECAN<br>ERR - Error interrupt<br>ECAN/CAN<br>WAK - Wake-Up Interrupt<br>ECAN/CAN<br>IVR - Invalid Message Received Interrupt<br>ECAN/CAN<br>RX0 - Receive Buffer 0 Interrupt<br>CAN<br>RX1 - Receive Buffer 1 Interrupt<br>CAN<br>TX0 - Transmit Buffer 0 Interrupt<br>CAN<br>TX1 - Transmit Buffer 1 Interrupt<br>CAN<br>TX2 - Transmit Buffer 2 Interrupt<br>CAN |
| <code>can_disable_interrupts(INTERRUPT setting)</code>  | Disable specified interrupt conditions so they doesn't cause the #INT_CAN1 interrupt to be triggered. Available options are the same as for  |

|  |  |
|--|--|
| <p>can_config_DMA(void)</p>  | <p>the can_enable_interrupts() function. By default all conditions are disabled.</p> <p>Configures the DMA buffers to use with the ECAN module. It is called inside the can_init() function so there is no need to call it. ECAN</p> <p>Examples:<br/> can2_init();<br/> can2_kbhit();</p>   |
| <p>For PICs that have two CAN or ECAN modules all the above function are available for the second module, and they start with can2 instead of can.</p> <p>Relevant Preprocessor:</p> | <p>None</p>  |
| <p>Relevant Interrupts:<br/> #INT_CAN1</p> <p>#INT_CAN2</p>  | <p>Interrupt for CAN or ECAN module 1. This interrupt is triggered when one of the conditions set by the can_enable_interrupts() is met.</p> <p>Interrupt for CAN or ECAN module 2. This interrupt is triggered when one of the conditions set by the can2_enable_interrupts() is met. This interrupt is only available on PICs that have two CAN or ECAN modules.</p> |
| <p>Relevant Include Files:<br/> can-mcp2510.c</p> <p>can-dsPIC30.c</p> <p>can-PIC24.c</p>  | <p>Drivers for the MCP2510 and MCP2515 interface chips.</p> <p>Drivers for the built in CAN module on dsPIC30F chips.</p> <p>Drivers for the built in ECAN module on PIC24HJ and dsPIC33FJ chips.</p>  |
| <p>Relevant getenv() Parameters:<br/> Example Code:<br/> can_init();<br/> can_putd(0x300,data,8,3,TRUE,FALSE);</p>   | <p>None</p> <p>// Initializes the CAN bus.<br/> // Places a message on the CAN bus with<br/> // ID = 0x300 and eight bytes of data pointed to by<br/> // "data", the TRUE causes an extended ID to be<br/> // sent, the FALSE causes no remote<br/> // transmission<br/> // to be requested.</p>   |
| <p>can_getd(ID,data,len,stat);</p>   | <p>// Retrieves a message from the CAN bus<br/> storing the<br/> // ID in the ID variable, the data at the array<br/> pointed<br/> // to by "data", the number of data bytes in len,<br/> // and statistics about the data in the stat<br/> structure.</p>   |

## Configuration Memory

On all dsPIC30, dsPIC33 and PIC24s the configuration memory is readable and writeable. The configuration memory contains the configuration bits for things such as the oscillator mode, watchdog timer enable, etc. These configuration bits are set by the CCS C compiler usually through a #fuse. CCS provides an API that allows these bits to be changed in run-time.

Relevant Functions:

`write_configuration_memory(ramPtr, n);`      Writes n bytes to configuration from ramPtr, no erase needed

or

`write_configuration_memory(offset, ramPtr, n);`      Write n bytes to configuration memory, starting at offset, from ramPtr \*/

`read_configuration_memory(ramPtr, n);`      Read n bytes of configuration memory, save to ramPtr

**Relevant Preprocessor:**      The initial value of the configuration memory is set through a #FUSE

Relevant Interrupts :      None

Relevant Include Files:      None, all functions built-in

**Relevant getenv() parameters:**      None

Example Code:

```
int16 data = 0x0C32;
write_configuration_memory (&data, 2);      //writes 2 bytes to the configuration memory
```

## CRC

The programmable Cyclic Redundancy Check (CRC) is a software configurable CRC checksum generator in select PIC24F, PIC24H, PIC24EP, and dsPIC33EP devices. The checksum is a unique number associated with a message or a block of data containing several bytes. The built-in CRC module has the following features:

- Programmable bit length for the CRC generator polynomial. (up to 32 bit length)
- Programmable CRC generator polynomial.
- Interrupt output.
- 4-deep, 8-deep, 16-bit, 16-deep or 32-deep, 8-bit FIFO for data input.
- Programmed bit length for data input. (32-bit CRC Modules Only)

Relevant Functions:

[setup\\_crc \(polynomial\)](#)  
[crc\\_init \(data\)](#)  
[crc\\_calc \(data\)](#)

This will setup the CRC polynomial.  
 Sets the initial value used by the CRC module.  
 Returns the calculated CRC value.

Relevant Preprocessor:

None

**Relevant Interrupts :**

#INT\_CRC                      On completion of CRC calculation.

Relevant Include Files:

None, all functions built-in

Relevant getenv() parameters:

None

Example Code:

```
Int16 data[8];
int16 result;
```

```
setup_crc(15, 3, 1);                      // CRC Polynomial is X16 + X15 + X3 + X1 + 1 or
                                         Polynomial = 8005h
crc_init(0xFEEE);                         Starts the CRC accumulator out at 0xFEEE
Result = crc_calc(&data[0], 8);         Calculate the CRC
```

## DAC

These options let the user configure and use the digital to analog converter module. They are only available on devices with the DAC hardware. The options for the functions and directives vary depending on the chip and are listed in the device header file.

Relevant Functions:

[setup\\_dac\(divisor\)](#)                      Sets up the DAC e.g. Reference voltages

[dac\\_write\(value\)](#)                         Writes the 8-bit value to the DAC module

[setup\\_dac\(mode, divisor\)](#)                 Sets up the d/a mode e.g. Right enable, clock divisor

[dac\\_write\(channel, value\)](#)                 Writes the 16-bit value to the specified channel

Relevant Preprocessor:

#USE\_DELAY                      Must add an auxiliary clock in the #use delay preprocessor.

## TEST PCD

For example:

```
#USE DELAY(clock=20M, Aux: crystal=6M, clock=3M)
```

Relevant Interrupts:

None

Relevant Include Files:

None, all functions built-in

**Relevant getenv()**

**parameters:**

None

Example Code:

```
int16 i = 0;
setup_dac(DAC_RIGHT_ON, //enables the d/a module with right channel enabled and a
5); //division of the clock by 5
While(1){
i++;
dac_write(DAC_RIGHT, i); //writes i to the right DAC channel
}
```

## Data Eeprom

The data eeprom memory is readable and writable in some chips. These options lets the user read and write to the data eeprom memory. These functions are only available in flash chips.

Relevant Functions:

*(8 bit or 16 bit depending on the device)*

|  |   |
|--|---|
| <code>read_eeprom(address)</code>              | Reads the data EEPROM memory location   |
| <code>write_eeprom(address, value)</code>      | Erases and writes value to data EEPROM location address.  |
| <code>read_eeprom(address, [N])</code>         | Reads N bytes of data EEPROM starting at memory location address. The maximum return size is int64. |
| <code>read_eeprom(address, [variable])</code>  | Reads from EEPROM to fill variable starting at address  |
| <code>read_eeprom(address, pointer, N)</code>  | Reads N bytes, starting at address, to pointer  |
| <code>write_eeprom(address, value)</code>      | Writes value to EEPROM address  |
| <code>write_eeprom(address, pointer, N)</code> | Writes N bytes to address from pointer  |

Relevant Preprocessor:

`#ROM address={list}` Can also be used to put data EEPROM memory data into the hex file.

`write_eeprom = noint` Allows interrupts to occur while the `write_eeprom()` operations is polling the done bit to check if the write



operations has completed. Can be used as long as no EEPROM operations are performed during an ISR.

Relevant Interrupts:

INT\_EEPROM

Interrupt fires when EEPROM write is complete

Relevant Include Files:

None, all functions built-in

**Relevant getenv() parameters:**

DATA\_EEPROM

Size of data EEPROM memory.

Example Code:

```
#ROM // Inserts this data into the hex file
0x007FFC00={1,2,3,4,5}

// The data EEPROM address differs between PICs
// Please refer to the device editor for device specific values.
write_eeprom(0x10, 0x1337); // Writes 0x1337 to data EEPROM location 10.
value=read_eeprom(0x0); // Reads data EEPROM location 10 returns 0x1337.
```

## DCI

DCI is an interface that is found on several dsPIC devices in the 30F and the 33FJ families. It is a multiple-protocol interface peripheral that allows the user to connect to many common audio codecs through common (and highly configurable) pulse code modulation transmission protocols. Generic multichannel protocols, I2S and AC'97 (16 & 20 bit modes) are all supported.

Relevant Functions:

[setup\\_dci\(configuration, data size, rx config, tx config, sample rate\);](#)

Initializes the DCI module.

[setup\\_adc\\_ports\(value\)](#)

Sets the available adc pins to be analog or digital.

[set\\_adc\\_channel\(channel\)](#)

Specifies the channel to be use for the a/d call.

[read\\_adc\(mode\)](#)

Starts the conversion and reads the value. The mode can also control the functionality.

[adc\\_done\(\)](#)

Returns 1 if the ADC module has finished its conversion.

Relevant Preprocessor:

#DEVICE ADC=xx

Configures the read\_adc return size. For example, using a PIC with a 10 bit A/D you can use 8 or 10 for xx- 8 will return the most significant byte, 10 will return the full A/D reading of 10 bits.

## TEST PCD

Relevant Interrupts:

INT\_DCI                                      Interrupt fires on a number (user configurable) of data words received.

Relevant Include Files:                    None, all functions built-in

Relevant getenv() parameters:

None

Example Code:

```
signed int16 left_channel, right_channel;
```

```
dc_i_initialize((I2S_MODE | DCI_MASTER | DCI_CLOCK_OUTPUT |  
SAMPLE_RISING_EDGE | UNDERFLOW_LAST |  
MULTI_DEVICE_BUS),DCI_1WORD_FRAME  
| DCI_16BIT_WORD | DCI_2WORD_INTERRUPT, RECEIVE_SLOT0 | RECEIVE_SLOT1,  
TRANSMIT_SLOT0 | TRANSMIT_SLOT1, 6000);
```

```
...
```

```
dc_i_start();
```

```
...
```

```
while(1)
```

```
{  
    dc_i_read(&left_channel, &right_channel);  
    dc_i_write(&left_channel, &right_channel);  
}
```

## DMA

The Direct Memory Access (DMA) controller facilitates the transfer of data between the CPU and its peripherals without the CPU's assistance. The transfer takes place between peripheral data registers and data space RAM. The module has 8 channels and since each channel is unidirectional, two channels must be allocated to read and write to a peripheral. Each DMA channel can move a block of up to 1024 data elements after it generates an interrupt to the CPU to indicate that the lock is available for processing. Some of the key features of the DMA module are:

- Eight DMA Channels.
- Byte or word transfers.
- CPU interrupt after half or full block transfer complete.
- One-Shot or Auto-Repeat block transfer modes.
- Ping-Pong Mode (automatic switch between two DSPRAM start addresses after each block transfer is complete).

Relevant Functions:

`setup_dma(channel, peripheral, mode)`

Configures the DMA module to copy data from the specified peripheral to RAM allocated for the DMA channel.

`dma_start(channel, mode, address)`

Starts the DMA transfer for the specified channel in the specified mode of operation.

`dma_status(channel)`

This function will return the status of the specified channel in the DMA module.

Relevant Preprocessor:

None

**Relevant Interrupts :**

`#INT_DMA_X`

Interrupt on channel X after DMA block or half block transfer.

Relevant Include Files:

None, all functions built-in

Relevant `getenv()` parameters:

None

Example Code:

```
setup_dma(1, DMA_IN_SPI1, DMA_BYTE);
```

Setup channel 1 of the DMA module to read the SPI1 channel in byte mode.

```
dma_start(1, DMA_CONTINUOUS|
```

Start the DMA channel with the DMA RAM address of 0x2000

```
DMA_PING_PONG, 0x2000);
```

## Data Signal Modulator

The Data Signal Modulator (DSM) allows the user to mix a digital data stream (the “modulator signal”) with a carrier signal to produce a modulated output. Both the carrier and the modulator signals are supplied to the DSM module, either internally from the output of a peripheral, or externally through an input pin. The modulated output signal is generated by performing a logical AND operation of both the carrier and modulator signals and then it is provided to the MDOUT pin. Using this method, the DSM can generate the following types of key modulation schemes:

- Frequency Shift Keying (FSK)
- Phase Shift Keying (PSK)
- On-Off Keying (OOK)

## TEST PCD

### Relevant Functions:

*(8 bit or 16 bit depending on the device)*

|   |  |
|---|--|
| <code>setup_dsm(mode,source,carrier)</code> | Configures the DSM module and selects the source signal and carrier signals. |
| <code>setup_dsm(TRUE)</code>                | Enables the DSM module.  |
| <code>setup_dsm(FALSE)</code>               | Disables the DSM module.   |

Relevant Preprocessor: None

Relevant Interrupts: None

Relevant Include Files: None, all functions built-in

**Relevant `getenv()` parameters:** None

### Example Code:

```
setup_dsm(DSM_ENABLED |  
          DSM_OUTPUT_ENABLED,  
          DSM_SOURCE_UART1,  
          DSM_CARRIER_HIGH_VSS |  
          DSM_CARRIER_LOW_OC1);  
  
if(input(PIN_B0))  
    setup_dsm(FALSE);  
else  
    setup_dsm(TRUE);
```

//Enables DSM module with the output enabled and selects UART1  
//as the source signal and VSS as the high carrier signal and OC1's  
//PWM output as the low carrier signal.

Disable DSM module

Enable DSM module

## Extended RAM

Some PIC24 devices have more than 30K of RAM. For these devices a special method is required to access the RAM above 30K. This extended RAM is organized into pages of 32K bytes each, the first page of extended RAM starts on page 1.

### Relevant Functions:

[`write\_extended\_ram\(p,addr,ptr,n\);`](#)

Writes n bytes from ptr to extended RAM page p starting at address addr.

[`read\_extended\_ram\(p,addr,ptr,n\);`](#)

Reads n bytes from extended RAM page p

starting a address addr to ptr.

Relevant Preprocessor:  
None

Relevant Interrupts :  
None

**Relevant Include Files:**  
None, all functions built-in

Relevant getenv() parameters:  
None

Example Code:

```
write_extended_ram(1,0x100,WriteData,8); //Writes 8 bytes from WriteData to addresses
0x100
//to 0x107 of extended RAM page 1.
read_extended_ram(1,0x100,ReadData,8); //Reads 8 bytes from addresses 0x100 to
0x107 of
//extended RAM page 1 to ReadData.
```

## General Purpose I/O

These options let the user configure and use the I/O pins on the device. These functions will affect the pins that are listed in the device header file.

Relevant Functions:

|                                       |  |
|---------------------------------------|--|
| <a href="#">output_high(pin)</a>      | Sets the given pin to high state.  |
| <a href="#">output_low(pin)</a>       | Sets the given pin to the ground state.  |
| <a href="#">output_float(pin)</a>     | Sets the specified pin to the output mode. This will allow the pin to float high to represent a high on an open collector type of connection.                              |
| <a href="#">output_x(value)</a>       | Outputs an entire byte to the port.  |
| <a href="#">output_bit(pin,value)</a> | Outputs the specified value (0,1) to the specified I/O pin.  |
| <a href="#">input(pin)</a>            | The function returns the state of the indicated pin.   |
| <a href="#">input_state(pin)</a>      | This function reads the level of a pin without changing the direction of the pin as INPUT() does.  |
| <a href="#">set_tris_x(value)</a>     | Sets the value of the I/O port direction register. A '1' is an input and '0' is for output.  |
| <a href="#">input_change_x( )</a>     | This function reads the levels of the pins on the port, and compares them to the last time they were read to see if there was a change, 1 if there was, 0 if there wasn't. |

Relevant Preprocessor:  
[#USE STANDARD\\_IO\(port\)](#)

This compiler will use this directive by default and it will

## TEST PCD

`#USE FAST_IO(port)`

`#USE FIXED_IO  
(port_outputs=;in,pin?)`

### Relevant Interrupts:

None

### Relevant Include Files:

None, all functions built-in

### Relevant getenv() parameters:

PIN:pb

automatically inserts code for the direction register whenever an I/O function like `output_high()` or `input()` is used.

This directive will configure the I/O port to use the fast method of performing I/O. The user will be responsible for setting the port direction register using the `set_tris_x()` function.

This directive set particular pins to be used an input or output, and the compiler will perform this setup every time this pin is used.

Returns a 1 if bit b on port p is on this part

### Example Code:

```
#use fast_io(b)
...
Int8 Tris_value= 0x0F;
int1 Pin_value;
...
set_tris_b(Tris_value); //Sets B0:B3 as input and B4:B7 as output
output_high(PIN_B7); //Set the pin B7 to High
If(input(PIN_B0)){ //Read the value on pin B0, set B7 to low if pin B0
                    //is high
output_high(PIN_B7)
;}
```

## Input Capture

These functions allow for the configuration of the input capture module. The timer source for the input capture operation can be set to either Timer 2 or Timer 3. In capture mode the value of the selected timer is copied to the ICxBUF register when an input event occurs and interrupts can be configured to fire as needed.

### Relevant Functions:

`setup_capture(x, mode)`  
`get_capture(x, wait)`

Sets the operation mode of the input capture module x  
Reads the capture event time from the ICxBUF result register. If wait is true, program flow waits until a new result is present. Otherwise the oldest value in the buffer is returned.

### Relevant Preprocessor:

None

Relevant Interrupts:  
 INT\_ICx Interrupt fires on capture event as configured

Relevant Include Files: None, all functions built-in.

Relevant getenv() parameters: None

**Example Code:**

```

setup_timer3(TMR_INTERNAL | TMR_DIV_BY_8);
setup_capture(2, CAPTURE_FE | CAPTURE_TIMER3);
while(TRUE) {
    timerValue = get_capture(2, TRUE);
    printf("A module 2 capture event occurred at: %LU", timerValue);
}

```

## Internal Oscillator

Two internal oscillators are present in PCD compatible chips, a fast RC and slow RC oscillator circuit. In many cases (consult your target datasheet or family data sheet for target specifics) the fast RC oscillator may be connected to a PLL system, allowing a broad range of frequencies to be selected. The Watchdog timer is derived from the slow internal oscillator.

Relevant Functions:  
[setup\\_oscillator\(\)](#) Explicitly configures the oscillator.

Relevant Preprocessor:  
[#FUSES](#) Specifies the values loaded in the device configuration memory. May be used to setup the oscillator configuration.

Relevant Interrupts:  
[#int\\_oscfail](#) Interrupts on oscillator failure

Relevant Include Files: None, all functions built-in

Relevant getenv() parameters:  
 CLOCK Returns the clock speed specified by #use delay()  
 FUSE\_SETxxxx Returns 1 if the fuse xxxx is set.

Example Code: None

## Interrupts

The following functions allow for the control of the interrupt subsystem of the microcontroller. With these functions, interrupts can be enabled, disabled, and cleared. With the preprocessor directives, a default function can be called for any interrupt that does not have an associated isr, and a global function can replace the compiler generated interrupt dispatcher.

### Relevant Functions:

|                                   |  |
|-----------------------------------|--|
| <code>disable_interrupts()</code> | Disables the specified interrupt.  |
| <code>enable_interrupts()</code>  | Enables the specified interrupt.   |
| <code>ext_int_edge()</code>       | Enables the edge on which the edge interrupt should trigger. This can be either rising or falling edge.  |
| <code>clear_interrupt()</code>    | This function will clear the specified interrupt flag. This can be used if a global isr is used, or to prevent an interrupt from being serviced. |

### Relevant Preprocessor:

|                               |  |
|-------------------------------|--|
| <code>#INT_XXX level=x</code> | x is an int 0-7, that selects the interrupt priority level for that interrupt.                                     |
| <code>#INT_XXX fast</code>    | This directive makes use of shadow registers for fast register save.<br>This directive can only be used in one ISR |

### Relevant Interrupts:

|                           |   |
|---------------------------|---|
| <code>#int_default</code> | This directive specifies that the following function should be called if an interrupt is triggered but no routine is associated with that interrupt.  |
| <code>#int_global</code>  | This directive specifies that the following function should be called whenever an interrupt is triggered. This function will replace the compiler generated interrupt dispatcher.   |
| <code>#int_xxx</code>     | This directive specifies that the following function should be called whenever the xxx interrupt is triggered. If the compiler generated interrupt dispatcher is used, the compiler will take care of clearing the interrupt flag bits. |

### Relevant Include Files:

none, all functions built in.

### Relevant getenv() Parameters:

none

### Example Code:

```
#int_timer0
void timer0interrupt() // #int_timer associates the following function with the
```



```

enable_interrupts(TIMER0); // interrupt service routine that should be called
disable_interrtups(TIMER0); // enables the timer0 interrupt
clear_interrupt(TIMER0); // disables the timer0 interrupt
                        // clears the timer0 interrupt flag

```

## Linker

[#EXPORT \(options\)](#)

[#IMPORT \(options\)](#)

[#MODULE](#)

## Output Compare/PWM Overview

The following functions are used to configure the output compare module. The output compare has three modes of functioning. Single compare, dual compare, and PWM. In single compare the output compare module simply compares the value of the OCxR register to the value of the timer and triggers a corresponding output event on match. In dual compare mode, the pin is set high on OCxR match and then placed low on an OCxRS match. This can be set to either occur once or repeatedly. In PWM mode the selected timer sets the period and the OCxRS register sets the duty cycle. Once the OC module is placed in PWM mode the OCxR register becomes read only so the value needs to be set before placing the output compare module in PWM mode. For all three modes of operation, the selected timer can either be Timer 2 or Timer 3.

Relevant Functions:

|   |  |
|---|--|
| <a href="#">setup_comparex (x, mode)</a>            | Sets the <i>mode</i> of the output compare / PWM module <i>x</i>         |
| <a href="#">set_comparex_time ( x, ocr, [ocrs])</a> | Sets the OCR and optionally OCRS register values of module <i>x</i> .    |
| <a href="#">set_pwm_duty (x, value)</a>             | Sets the PWM duty cycle of module <i>x</i> to the specified <i>value</i> |

Relevant Preprocessor:

None

Relevant Interrupts:

|         |  |
|---------|--|
| INT_OCx | Interrupt fires after a compare event has occurred |
|---------|--|

Relevant Include Files:

None, all functions built-in.

Relevant getenv() parameters:

None

## TEST PCD

### Example Code:

```
// Outputs a 1 second pulse on the OC2 PIN
// using dual compare mode on a PIC
// with an instruction clock of (20Mhz/4)
int16 OCR_2 = 0x1000; // Start pulse when timer is at 0x1000
int16 OCRS_2 = 0x5C4B; // End pulse after 0x04C4B timer counts
                        // (0x1000 + 0x04C4B
                        // (1 sec)/[(4/20000000)*256] = 0x04C4B
                        // 256 = timer prescaler value (set in
                        // code below)

set_compare_time(2, OCR_2, OCRS_2);
setup_compare(2, COMPARE_SINGLE_PULSE | COMPARE_TIMER3);

setup_timer3(TMR_INTERNAL | TMR_DIV_BY_256);
```

## Motor Control PWM

These options lets the user configure the Motor Control Pulse Width Modulator (MCPWM) module. The MCPWM is used to generate a periodic pulse waveform which is useful is motor control and power control applications. The options for these functions vary depending on the chip and are listed in the device header file.

### Relevant Functions:

|  |   |
|--|---|
| <code>setup_motor_pwm(pwm,options, timebase);</code>                               | Configures the motor control PWM module.            |
| <code>set_motor_pwm_duty(pwm,unit,time)</code>                                     | Configures the motor control PWM unit duty.         |
| <code>set_motor_pwm_event(pwm,time)</code>   | Configures the PWM event on the motor control unit. |
| <code>set_motor_unit(pwm,unit,options, active_deadtime, inactive_deadtime);</code> | Configures the motor control PWM unit.              |
| <code>get_motor_pwm_event(pwm);</code>   | Returns the PWM event on the motor control unit.    |

### Relevant Preprocessor:

None

### Relevant Interrupts :

#INT\_PWM1 PWM Timebase Interrupt

### Relevant Include Files:

None, all functions built-in

Relevant getenv() parameters:

None

Example Code:

```
// Sets up the motor PWM module
setup_motor_pwm(1,MPWM_FREE_RUN | MPWM_SYNC_OVERRIDES, timebase);

// Sets the PWM1, Group 1 duty cycle value to 0x55
set_motor_pwm_duty(1,1,0x55);

//Set the motor PWM event
set_motor_pwm_event(pwm,time);
//Enable pwm pair
set_motor_unit(1,1,mpwm_ENABLE,0,0); //Enables pwm1, Group 1 in complementary
//mode, no deadtime
```

## PMP/EPMP

The Parallel Master Port (PMP)/Enhanced Parallel Master Port (EPMP) is a parallel 8-bit/16-bit I/O module specifically designed to communicate with a wide variety of parallel devices. Key features of the PMP module are:

- 8 or 16 Data lines
- Up to 16 or 32 Programmable Address Lines
- Up to 2 Chip Select Lines
- Programmable Strobe option
- Address Auto-Increment/Auto-Decrement
- Programmable Address/Data Multiplexing
- Programmable Polarity on Control Signals
- Legacy Parallel Slave(PSP) Support
- Enhanced Parallel Slave Port Support
- Programmable Wait States

Relevant Functions:

[setup\\_pmp](#)  
(options,address\_mask)

This will setup the PMP/EPMP module for various mode and specifies which address lines to be used.

[setup\\_psp](#)  
(options,address\_mask)

This will setup the PSP module for various mode and specifies which address lines to be used.



Relevant Functions:

|   |   |
|---|---|
| <code>read_program_eeprom(address)</code>                   | Reads the program memory location(16 bit or 32 bit depending on the device).  |
| <code>write_program_eeprom(address, value)</code>           | Writes value to program memory location address.  |
| <code>erase_program_eeprom(address)</code>                  | Erases FLASH_ERASE_SIZE bytes in program memory.  |
| <code>write_program_memory(address,dataptr,count)</code>    | Writes count bytes to program memory from dataptr to address. When address is a mutiple of FLASH_ERASE_SIZE an erase is also performed. |
| <code>read_program_memory(address,dataptr,count)</code>     | Read count bytes from program memory at address to dataptr.   |
| <code>write_rom_memory<br/>(address, dataptr, count)</code> | Writes <i>count</i> bytes to program memory from <i>address</i> (32 bits)   |
| <code>read_rom_memory (address, dataptr, count)</code>      | Read <i>count</i> bytes to program memory from <i>address</i> (32 bits)   |

Relevant Preprocessor:

|  |   |
|--|---|
| <code>#ROM address={list}</code>         | Can be used to put program memory data into the hex file.   |
| <code>#DEVICE(WRITE_EEPROM=ASYNC)</code> | Can be used with #DEVICE to prevent the write function from hanging. When this is used make sure the eeprom is not written both inside and outside the ISR. |

Relevant Interrupts:

|                         |  |
|-------------------------|--|
| <code>INT_EEPROM</code> | Interrupt fires when eeprom write is complete. |
|-------------------------|--|

Relevant Include Files:

None, all functions built-in

Relevant getenv() parameters

|                               |   |
|-------------------------------|---|
| <code>PROGRAM_MEMORY</code>   | Size of program memory                    |
| <code>READ_PROGRAM</code>     | Returns 1 if program memory can be read   |
| <code>FLASH_WRITE_SIZE</code> | Smallest number of bytes written in flash |
| <code>FLASH_ERASE_SIZE</code> | Smallest number of bytes erased in flash  |

## TEST PCD

### Example Code:

```
#ROM 0x300={1,2,3,4} // Inserts this data into the hex
                        // file.
erase_program_eeprom(0x00000300); // Erases 32 instruction
                                   // locations starting at 0x0300
write_program_eeprom(0x00000300,0x123456); // Writes 0x123456 to 0x0300
value=read_program_eeprom(0x00000300); // Reads 0x0300 returns 0x123456
write_program_memory(0x00000300,data,12); // Erases 32 instructions
                                           // starting
                                           // at 0x0300 (multiple of erase
                                           // block)
                                           // Writes 12 bytes from data to
                                           // 0x0300
read_program_memory(0x00000300,value,12); //reads 12 bytes to value from
                                           // 0x0300
```

For chips where `getenv("FLASH_ERASE_SIZE") > getenv("FLASH_WRITE_SIZE")`

`WRITE_PROGRAM_EEPROM`

- Writes 3 bytes, does not erase (use `ERASE_PROGRAM_EEPROM`)

`WRITE_PROGRAM_MEMORY`

- Writes any number of bytes, will erase a block whenever the first (lowest) byte in a block is written to. If the first address is not the start of a block that block is not erased

- While writing, every fourth byte will be ignored. Fill ignored bytes with 0x00. This is due to the 32 bit addressing and 24 bit instruction length on the PCD devices.

`WRITE_ROM_MEMORY`

- Writes any number of bytes, will erase a block whenever the first (lowest) byte in a block is written to. If the first address is not the start of a block that block is not erased.

`ERASE_PROGRAM_EEPROM`

- Erases a block of size `FLASH_ERASE_SIZE`. The lowest address bits are not used.

For chips where `getenv("FLASH_ERASE_SIZE") = get("FLASH_WRITE_SIZE")`

`WRITE_PROGRAM_EEPROM`

- Writes 3 bytes, no erase is needed.

`WRITE_PROGRAM_MEMORY`

- Writes any numbers of bytes, bytes outside the range of the write block are not changed. No erase is needed.

- While writing, every fourth byte will be ignored. Fill ignored bytes with 0x00. This is due to the 32 bit addressing and 24 bit instruction length on the PCD devices.

`WRITE_ROM_MEMORY`

- Writes any numbers of bytes, bytes outside the range of the write block are not changed. No erase is needed.

ERASE\_PROGRAM\_EEPROM

- Erase a block of size FLASH\_ERASE\_SIZE. The lowest address bits are not used.

## QEI

The Quadrature Encoder Interface (QEI) module provides the interface to incremental encoders for obtaining mechanical positional data.

Relevant Functions:

`setup_qei(options, filter,maxcount)`

Configures the QEI module.

`qei_status( )`

Returns the status of the QEI module.

`qei_set_count(value)`

Write a 16-bit value to the position counter.

`qei_get_count( )`

Reads the current 16-bit value of the position counter.

Relevant Preprocessor:

None

**Relevant Interrupts :**

`#INT_QEI`

Interrupt on rollover or underflow of the position counter.

Relevant Include Files:

None, all functions built-in

Relevant getenv() parameters:

None

Example Code:

`int16 Value;`

`setup_qei(QEI_MODE_X2 |`

Setup the QEI module

`QEI_TIMER_INTERNAL,`

`QEI_FILTER_DIV_2,QEI_FORWARD);`

`Value = qei_get_count( );`

Read the count.

## RS232 I/O

These functions and directives can be used for setting up and using RS232 I/O functionality.

Relevant Functions:

`getc()` or `getch()`

Gets a character on the receive pin(from the specified stream in case of `fgetc`, `stdin` by default). Use `KBHIT` to check if the character is available.

`getchar()` or `fgetc()`

## TEST PCD

|  |   |
|--|---|
| <code>gets()</code> or <code>fgets()</code>  | Gets a string on the receive pin(from the specified stream in case of <code>fgets</code> , <code>STDIN</code> by default). Use <code>getc</code> to receive each character until return is encountered.   |
| <code>putc()</code> or <code>putchar()</code> or <code>fputc()</code>                        | Puts a character over the transmit pin(on the specified stream in the case of <code>fputc</code> , <code>stdout</code> by default)  |
| <code>puts()</code> or <code>fputs()</code>  | Puts a string over the transmit pin(on the specified stream in the case of <code>fputc</code> , <code>stdout</code> by default). Uses <code>putc</code> to send each character.   |
| <code>printf()</code> or <code>fprintf()</code>  | Prints the formatted string(on the specified stream in the case of <code>fprintf</code> , <code>stdout</code> by default). Refer to the <code>printf</code> help for details on format string.  |
| <code>kbhit()</code>   | Return true when a character is received in the buffer in case of hardware RS232 or when the first bit is sent on the RCV pin in case of software RS232. Useful for polling without waiting in <code>getc</code> .  |
| <code>setup_uart(baud,[stream])</code><br>or<br><code>setup_uart_speed(baud,[stream])</code> | Used to change the baud rate of the hardware UART at run-time. Specifying stream is optional. Refer to the help for more advanced options.  |
| <code>assert(condition)</code>   | Checks the condition and if false prints the file name and line to <code>STDERR</code> . Will not generate code if <code>#DEFINE NODEBUG</code> is used.  |
| <code>perror(message)</code>   | Prints the message and the last system error to <code>STDERR</code> .   |
| Relevant Preprocessor:<br><code>#USE RS232(options)</code>                                   | This directive tells the compiler the baud rate and other options like transmit, receive and enable pins. Please refer to the <code>#USE RS232</code> help for more advanced options. More than one <code>RS232</code> statements can be used to specify different streams. If stream is not specified the function will use the last <code>#USE RS232</code> . |
| <b>Relevant Interrupts:</b><br><code>INT_RDA</code><br><code>INT_TBE</code>                  | <code>INT_RDA</code> Interrupt fires when the receive data available<br><code>INT_TBE</code> Interrupt fires when the transmit data empty   |

Some chips have more than one hardware uart, and hence more interrupts.

**Relevant Include Files:**  
None, all functions built-in



Relevant getenv() parameters:

UART – Returns the number of UARTs on this PIC

AUART – Returns true if this UART is an advanced UART

UART\_RX – Returns the receive pin for the first UART on this PIC (see PIN\_XX)

UART\_TX – Returns the transmit pin for the first UART on this PIC

UART2\_RX – Returns the receive pin for the second UART on this PIC

UART2\_TX – Returns the transmit pin for the second UART on this PIC

Example Code:

```
/* configure and enable uart, use first hardware UART on PIC */
#include rs232(uart1, baud=9600)

/* print a string */
printf("enter a character");

/* get a character */
if (kbhit()) //wait until a character has been received
    c = getch(); //read character from UART
```

## RTCC

The Real Time Clock and Calendar (RTCC) module is intended for applications where accurate time must be maintained for extended periods of time with minimum or no intervention from the CPU. The key features of the module are:

- Time: Hour, Minute and Seconds.
- 24-hour format (Military Time)
- Calendar: Weekday, Date, Month and Year.
- Alarm Configurable.
- Requirements: External 32.768 kHz Clock Crystal.

Relevant Functions:

|   |  |
|---|--|
| <a href="#">setup_rtc (options, calibration);</a>       | This will setup the RTCC module for operation and also allows for calibration setup. |
| <a href="#">rtc_write(time_t datetime)</a>              | Writes the date and time to the RTCC module.   |
| <a href="#">rtc_read(time_t datetime)</a>               | Reads the current value of Time and Date from the RTCC module.                       |
| <a href="#">setup_rtc_alarm(options, mask, repeat);</a> | Configures the alarm of the RTCC module.   |
| <a href="#">rtc_alarm_write(time_t datetime);</a>       | Writes the date and time to the alarm in the RTCC module.                            |
| <a href="#">rtc_alarm_read(time_t datetime);</a>        | Reads the date and time to the alarm in the RTCC module.                             |

Relevant Preprocessor:

None



|                                       |   |
|---------------------------------------|---|
| <code>rtos_msg_send(task,byte)</code> | Sends a byte of data to the specified task. The data is placed in the receiving task's message queue.   |
| <code>rtos_yield()</code>             | Called with in one of the RTOS tasks and returns control of the program to the <code>rtos_run()</code> function. All tasks should call this function when finished.               |
| <code>rtos_signal(sem)</code>         | Increments a semaphore which is used to broadcast the availability of a limited resource.   |
| <code>rtos_wait(sem)</code>           | Waits for the resource associated with the semaphore to become available and then decrements to semaphore to claim the resource.  |
| <code>rtos_await(expre)</code>        | Will wait for the given expression to evaluate to true before allowing the task to continue.  |
| <code>rtos_overrun(task)</code>       | Will return true if the given task over ran its allotted time.  |
| <code>rtos_stats(task,stat)</code>    | Returns the specified statistic about the specified task. The statistics include the minimum and maximum times for the task to run and the total time the task has spent running. |

Relevant Preprocessor:

**#USE RTOS(options)** This directive is used to specify several different RTOS attributes including the timer to use, the minor cycle time and whether or not statistics should be enabled.

**#TASK(options)** This directive tells the compiler that the following function is to be an RTOS task.

**#TASK** specifies the rate at which the task should be called, the maximum time the task shall be allowed to run, and how large it's queue should be.

**Relevant Interrupts:**

none

Relevant Include Files:

none all functions are built in

Relevant getenv() Parameters:

none

Example Code:

```
#USE RTOS(timer=0,minor_cycle=20ms) // RTOS will use timer zero, minor cycle will be 20ms
```

```
...
```

```
int sem;
```

## TEST PCD

```
...
#TASK(rate=1s,max=20ms,queue=5) // Task will run at a rate of once per second
void task_name();                // with a maximum running time of 20ms and
                                // a 5 byte queue
rtos_run();                       // begins the RTOS
rtos_terminate();                 // ends the RTOS

rtos_enable(task_name);          // enables the previously declared task.
rtos_disable(task_name);        // disables the previously declared task

rtos_msg_send(task_name,5);      // places the value 5 in task_names queue.
rtos_yield();                   // yields control to the RTOS
rtos_signal(sem);               // signals that the resource represented by sem is available.
```

For more information on the CCS RTOS please

## SPI

SPI™ is a fluid standard for 3 or 4 wire, full duplex communications named by Motorola. Most PIC devices support most common SPI™ modes. CCS provides a support library for taking advantage of both hardware and software based SPI™ functionality. For software support, see [#USE SPI](#).

Relevant Functions:

|   |  |
|---|--|
| <a href="#">setup_spi(mode)</a><br><a href="#">setup_spi2</a> | Configure the hardware SPI to the specified mode. The mode configures <a href="#">setup_spi2(mode)</a> thing such as master or slave mode, clock speed and clock/data trigger configuration. |
|---|--|

Note: for devices with dual SPI interfaces a second function, [setup\\_spi2\(\)](#), is provided to configure the second interface.

|   |  |
|---|--|
| <a href="#">spi_data_is_in()</a><br><a href="#">spi_data_is_in2()</a> | Returns TRUE if the SPI receive buffer has a byte of data. |
|---|--|

|   |  |
|---|--|
| <a href="#">spi_write(value)</a><br><a href="#">spi_write2(value)</a> | Transmits the value over the SPI interface. This will cause the data to be clocked out on the SDO pin. |
|---|--|

|   |   |
|---|---|
| <a href="#">spi_read(value)</a><br><a href="#">spi_read2(value)</a> | Performs an SPI transaction, where the value is clocked out on the SDO pin and data clocked in on the SDI pin is returned. If you just want to clock in data then you can use <a href="#">spi_read()</a> without a parameter. |
|---|---|

Relevant  
Preprocessor:  
None

## Relevant Interrupts:

|           |  |
|-----------|--|
| #int_sspA | Transaction (read or write) has completed on the indicated peripheral. |
| #int_ssp2 |  |
| #int_spi1 | Interrupts on activity from the first SPI module                       |
| #int_spi2 | Interrupts on activity from the second SPI module                      |

**Relevant Include Files:**

None, all functions built-in to the compiler.

## Relevant getenv() Parameters:

|     |  |
|-----|--|
| SPI | Returns TRUE if the device has an SPI peripheral |
|-----|--|

## Example Code:

```
//configure the device to be a master, data transmitted on H-to-L clock transition
setup_spi(SPI_MASTER | SPI_H_TO_L | SPI_CLK_DIV_16);
```

```
spi_write(0x80);           //write 0x80 to SPI device
value=spi_read();         //read a value from the SPI device
value=spi_read(0x80);     //write 0x80 to SPI device the same time you are reading a value.
```

## TimerA

These options lets the user configure and use timerA. It is available on devices with Timer A hardware. The clock/counter is 8 bit. It counts up and also provides interrupt on overflow. The options available are listed in the device's header file.

## Relevant Functions:

|                                     |  |
|-------------------------------------|--|
| <a href="#">setup_timer_A(mode)</a> | Disable or sets the source and prescale for timerA |
| <a href="#">set_timerA(value)</a>   | Initializes the timerA clock/counter               |
| <a href="#">value=get_timerA()</a>  | Returns the value of the timerA clock/counter      |

## Relevant Preprocessor:

None

## Relevant Interrupts :

|             |                                       |
|-------------|---------------------------------------|
| INT_TIMER_A | Interrupt fires when timerA overflows |
|-------------|---------------------------------------|

## Relevant Include Files:

None, all functions built-in

## TEST PCD

Relevant getenv() parameters:

TIMERA Returns 1 if the device has timerA

Example Code:

```
setup_timer_A(TA_OFF); //disable timerA  
  
or  
  
setup_timer_A //sets the internal clock as source  
(TA_INTERNAL | TA_DIV_8); //and prescale as 8. At 20MHz timerA will increment  
//every 1.6us in this setup and overflows every  
//409.6us  
  
set_timerA(0); //this sets timerA register to 0  
time=get_timerA(); //this will read the timerA register value
```

## TimerB

These options lets the user configure and use timerB. It is available on devices with Timer B hardware. The clock/counter is 8 bit. It counts up and also provides interrupt on overflow. The options available are listed in the device's header file.

Relevant Functions:

[setup\\_timer\\_B\(mode\)](#) Disable or sets the source and prescale for timerB  
[set\\_timerB\(value\)](#) Initializes the timerB clock/counter  
[value=get\\_timerB\(\)](#) Returns the value of the timerB clock/counter

Relevant Preprocessor:

None

Relevant Interrupts :

INT\_TIMERB Interrupt fires when timerB overflows

Relevant Include Files:

None, all functions built-in

Relevant getenv() parameters:

TIMERB Returns 1 if the device has timerB

Example Code:

```

setup_timer_B(TB_OFF); //disable timerB

or

setup_timer_B //sets the internal clock as source
(TB_INTERNAL | TB_DIV_8); //and prescale as 8. At 20MHz timerB will increment
//every 1.6us in this setup and overflows every
//409.6us

set_timerB(0); //this sets timerB register to 0

time=get_timerB(); //this will read the timerB register value

```

## Timers

The 16-bit DSC and MCU families implement 16 bit timers. Many of these timers may be concatenated into a hybrid 32 bit timer. Also, one timer may be configured to use a low power 32.768 kHz oscillator which may be used as a real time clock source.

Timer1 is a 16 bit timer. It is the only timer that may not be concatenated into a hybrid 32 bit timer. However, it alone may use a synchronous external clock. This feature may be used with a low power 32.768 kHz oscillator to create a real-time clock source.

Timers 2 through 9 are 16 bit timers. They may use external clock sources only asynchronously and they may not act as low power real time clock sources. They may however be concatenated into 32 bit timers. This is done by configuring an even numbered timer (timer 2, 4, 6 or 8) as the least significant word, and the corresponding odd numbered timer (timer 3, 5, 7 or 9, respectively) as the most significant word of the new 32 bit timer.

Timer interrupts will occur when the timer overflows. Overflow will happen when the timer surpasses its period, which by default is 0xFFFF. The period value may be changed when using `setup_timer_X`.

Relevant Functions:

`setup_timer_X()` Configures the timer peripheral. X may be any valid timer for the target device. Consult the target datasheet or use `getenv` to find the valid timers.

`get_timerX()` Retrieves the current 16 bit value of the timer.

`get_timerXY()` Gets the 32 bit value of the concatenated timers X and Y (where XY

## TEST PCD

`set_timerX()` may only be 23, 45, 67, 89)  
Sets the value of timerX  
`set_timerXY()` Sets the 32 bit value of the concatenated timers X and Y (where XY may only be 23, 45, 67, 89)

Relevant Preprocessor:  
None

Relevant Interrupts:  
`#int_timerX` Interrupts on timer overflow (period match). X is any valid timer number.  
\*When using a 32-bit timer, the odd numbered timer-interrupt of the hybrid timer must be used. (i.e. when using 32-bit Timer23, `#int_timer3`)

**Relevant Include Files:**  
None, all functions built-in

Relevant `getenv()` parameters:  
`TIMERX` Returns 1 if the device has the timer peripheral X. X may be 1 - 9

### Example Code:

```
/* Setup timer1 as an external real time clock that increments every 16 clock
cycles */
setup_timer1(T1_EXTERNAL_RTC | T2_DIV_BY_16 );
/* Setup timer2 as a timer that increments on every instruction cycle and has a
period of 0x0100 */
setup_timer2(TMR_INTERNAL, 0x0100);
byte value = 0x00;
value = get_timer2(); //retrieve the current value of timer2
```

## Voltage Reference

These functions configure the voltage reference module. These are available only in the supported chips.

**Relevant Functions:**  
`setup_vref(mode| value)` Enables and sets up the internal voltage reference value.  
Constants are defined in the devices .h file.

**Relevant Preprocessor:**  
None

Relevant Interrupts:  
None



Relevant Include Files:  
None, all functions built-in

Relevant getenv() parameters:

VREF Returns 1 if the device has VREF

Example Code:

For eg:

For PIC12F675

```
#INT_COMP //comparator interrupt handler
```

```
void isr() {
```

```
    safe_conditions=FALSE;
```

```
    printf("WARNING!! Voltage level is above 3.6 V. \r\n");
```

```
}
```

```
    setup_comparator(A1_VR_OUT_ON_A2); // sets two comparators(A1 and VR and A2 as the
                                        output)
```

```
    setup_vref(VREF_HIGH|15); //sets 3.6(vdd *value/32 +vdd/4) if vdd is 5.0V
```

```
    enable_interrupts(INT_COMP); //enables the comparator interrupt
```

```
    enable_interrupts(GLOBAL); //enables global interrupts
```

## WDT or Watch Dog Timer

Different chips provide different options to enable/disable or configure the WDT.

Relevant Functions:

setup\_wdt()

Enables/disables the wdt or sets the prescalar.

restart\_wdt()

Restarts the wdt, if wdt is enables this must be periodically called to prevent a timeout reset.

For PCB/PCM chips it is enabled/disabled using WDT or NOWDT fuses whereas on PCH device it is done using the setup\_wdt function.

The timeout time for PCB/PCM chips are set using the setup\_wdt function and on PCH using fuses like WDT16, WDT256 etc.

RESTART\_WDT when specified in #USE DELAY, #USE I2C and #USE RS232 statements like this #USE DELAY(clock=20000000, restart\_wdt) will cause the wdt to restart if it times out during the delay or I2C\_READ or GETC.

Relevant Preprocessor:

**#FUSES WDT/NOWDT**

Enabled/Disables wdt in PCB/PCM devices

**#FUSES WDT16**

Sets ups the timeout time in PCH devices

Relevant Interrupts:

## TEST PCD

None

Relevant Include Files:

None, all functions built-in

Relevant getenv() parameters:

None

Example Code:

For eg:

For PIC16F877

```
#fuses wdt
setup_wdt(WDT_2304MS);
while(true){
    restart_wdt();
    perform_activity();
}
```

For PIC18F452

```
#fuse WDT1
setup_wdt(WDT_ON);
while(true){
    restart_wdt();
    perform_activity();
}
```

Some of the PCB chips are share the WDT prescalar bits with timer0 so the WDT prescalar constants can be used with setup\_counters or setup\_timer0 or setup\_wdt functions.

# PRE-PROCESSOR



## #ASM #ENDASM

Syntax: #ASM or #ASM ASIS code #ENDASM

Elements: code is a list of assembly language instructions

Purpose: The lines between the #ASM and #ENDASM are treated as assembly code to be inserted. These may be used anywhere an expression is allowed. The syntax is described on the following page. Function return values are sent in W0 for 16-bit, and W0, w1 for 32 bit. Be aware that any C code after the #ENDASM and before the end of the function may corrupt the value. If the second form is used with ASIS then the compiler will not do any optimization on the assembly. The assembly code is used as-is.

Examples: 

```
int find_parity(int data){int count;#asm MOV #0x08, W0 MOV W0, count CLR W0 loop:XOR.B data,W0 RRC data, W0 DEC count,F BRA NZ, loop MOV #0x01,W0 ADD count, FMOV count, W0 MOV W0, _RETURN_ #endasm }
```

Example Files: ex\_glint.c

Also See: None

|       |               |                              |
|-------|---------------|------------------------------|
| ADD   | Wa,Wb,Wd      | Wd = Wa+Wb                   |
| ADD   | f,W           | W0 = f+Wd                    |
| ADD   | lit10,Wd      | Wd = lit10+Wd                |
| ADD   | Wa,lit5,Wd    | Wd = lit5+Wa                 |
| ADD   | f,F           | f = f+Wd                     |
| ADD   | acc           | Acc = AccA+AccB              |
| ADD   | Wd,{lit4},acc | Acc = Acc+(Wa shifted slit4) |
| ADD.B | lit10,Wd      | Wd = lit10+Wd (byte)         |
| ADD   | Wd,{lit4},acc | Acc = Acc+(Wa shifted slit4) |
| ADD.B | lit10,Wd      | Wd = lit10+Wd (byte)         |
| ADD.B | f,F           | f = f+Wd (byte)              |
| ADD.B | Wa,Wb,Wd      | Wd = Wa+Wb (byte)            |

## TEST PCD

|        |            |                               |
|--------|------------|-------------------------------|
| ADD.B  | Wa,lit5,Wd | Wd = lit5+Wa (byte)           |
| ADD.B  | f,W        | W0 = f+Wd (byte)              |
| ADDC   | f,W        | Wd = f+Wa+C                   |
| ADDC   | lit10,Wd   | Wd = lit10+Wd+C               |
| ADDC   | Wa,lit5,Wd | Wd = lit5+Wa+C                |
| ADDC   | f,F        | Wd = f+Wa+C                   |
| ADDC   | Wa,Wb,Wd   | Wd = Wa+Wb+C                  |
| ADDC.B | lit10,Wd   | Wd = lit10+Wd+C (byte)        |
| ADDC.B | Wa,Wb,Wd   | Wd = Wa+Wb+C (byte)           |
| ADDC.B | Wa,lit5,Wd | Wd = lit5+Wa+C (byte)         |
| ADDC.B | f,W        | Wd = f+Wa+C (byte)            |
| ADDC.B | f,F        | Wd = f+Wa+C (byte)            |
| AND    | Wa,Wb,Wd   | Wd = Wa.&.Wb                  |
| AND    | lit10,Wd   | Wd = lit10.&.Wd               |
| AND    | f,W        | W0 = f.&.Wa                   |
| AND    | f,F        | f = f.&.Wa                    |
| AND    | Wa,lit5,Wd | Wd = lit5.&.Wa                |
| AND.B  | f,W        | W0 = f.&.Wa (byte)            |
| AND.B  | Wa,Wb,Wd   | Wd = Wa.&.Wb (byte)           |
| AND.B  | lit10,Wd   | Wd = lit10.&.Wd (byte)        |
| AND.B  | f,F        | f = f.&.Wa (byte)             |
| AND.B  | Wa,lit5,Wd | Wd = lit5.&.Wa (byte)         |
| ASR    | f,W        | W0 = f >> 1 arithmetic        |
| ASR    | f,F        | f = f >> 1 arithmetic         |
| ASR    | Wa,Wd      | Wd = Wa >> 1 arithmetic       |
| ASR    | Wa,lit4,Wd | Wd = Wa >> lit4 arithmetic    |
| ASR    | Wa,Wb,Wd   | Wd = Wa >> Wb arithmetic      |
| ASR.B  | f,F        | f = f >> 1 arithmetic (byte)  |
| ASR.B  | f,W        | W0 = f >> 1 arithmetic (byte) |

|         |       |  |
|---------|-------|--|
| ASR.B   | Wa,Wd | Wd = Wa >> 1 arithmetic (byte)           |
| BCLR    | f,B   | f.bit = 0                                |
| BCLR    | Wd,B  | Wa.bit = 0                               |
| BCLR.B  | Wd,B  | Wa.bit = 0 (byte)                        |
| BRA     | a     | Branch unconditionally                   |
| BRA     | Wd    | Branch PC+Wa                             |
| BRA BZ  | a     | Branch if Zero                           |
| BRA C   | a     | Branch if Carry (no borrow)              |
| BRA GE  | a     | Branch if greater than or equal          |
| BRA GEU | a     | Branch if unsigned greater than or equal |
| BRA GT  | a     | Branch if greater than                   |
| BRA GTU | a     | Branch if unsigned greater than          |
| BRA LE  | a     | Branch if less than or equal             |
| BRA LEU | a     | Branch if unsigned less than or equal    |
| BRA LT  | a     | Branch if less than                      |
| BRA LTU | a     | Branch if unsigned less than             |
| BRA N   | a     | Branch if negative                       |
| BRA NC  | a     | Branch if not carry (Borrow)             |
| BRA NN  | a     | Branch if not negative                   |
| BRA NOV | a     | Branch if not Overflow                   |
| BRA NZ  | a     | Branch if not Zero                       |
| BRA OA  | a     | Branch if Accumulator A overflow         |
| BRA OB  | a     | Branch if Accumulator B overflow         |
| BRA OV  | a     | Branch if Overflow                       |
| BRA SA  | a     | Branch if Accumulator A Saturate         |
| BRA SB  | a     | Branch if Accumulator B Saturate         |
| BRA Z   | a     | Branch if Zero                           |
| BREAK   |       | ICD Break                                |
| BSET    | Wd,B  | Wa.bit = 1                               |

## TEST PCD

|         |              |                         |
|---------|--------------|-------------------------|
| BSET    | f,B          | f.bit = 1               |
| BSET.B  | Wd,B         | Wa.bit = 1 (byte)       |
| BSW.C   | Wa,Wd        | Wa.Wb = C               |
| BSW.Z   | Wa,Wd        | Wa.Wb = Z               |
| BTG     | Wd,B         | Wa.bit = ~Wa.bit        |
| BTG     | f,B          | f.bit = ~f.bit          |
| BTG.B   | Wd,B         | Wa.bit = ~Wa.bit (byte) |
| BTSC    | f,B          | Skip if f.bit = 0       |
| BTSC    | Wd,B         | Skip if Wa.bit4 = 0     |
| BTSS    | f,B          | Skip if f.bit = 1       |
| BTSS    | Wd,B         | Skip if Wa.bit = 1      |
| BTST    | f,B          | Z = f.bit               |
| BTST.C  | Wa,Wd        | C = Wa.Wb               |
| BTST.C  | Wd,B         | C = Wa.bit              |
| BTST.Z  | Wd,B         | Z = Wa.bit              |
| BTST.Z  | Wa,Wd        | Z = Wa.Wb               |
| BTSTS   | f,B          | Z = f.bit; f.bit = 1    |
| BTSTS.C | Wd,B         | C = Wa.bit; Wa.bit = 1  |
| BTSTS.Z | Wd,B         | Z = Wa.bit; Wa.bit = 1  |
| CALL    | a            | Call subroutine         |
| CALL    | Wd           | Call [Wa]               |
| CLR     | f,F          | f = 0                   |
| CLR     | acc,da,dc,pi | Acc = 0; prefetch=0     |
| CLR     | f,W          | W0 = 0                  |
| CLR     | Wd           | Wd = 0                  |
| CLR.B   | f,W          | W0 = 0 (byte)           |
| CLR.B   | Wd           | Wd = 0 (byte)           |
| CLR.B   | f,F          | f = 0 (byte)            |
| CLRWDT  |              | Clear WDT               |

|         |         |   |
|---------|---------|---|
| COM     | f,F     | f = ~f  |
| COM     | f,W     | W0 = ~f   |
| COM     | Wa,Wd   | Wd = ~Wa  |
| COM.B   | f,W     | W0 = ~f (byte)                                      |
| COM.B   | Wa,Wd   | Wd = ~Wa (byte)                                     |
| COM.B   | f,F     | f = ~f (byte)                                       |
| CP      | W,f     | Status set for f - W0                               |
| CP      | Wa,Wd   | Status set for Wb $\hat{=}$ Wa                      |
| CP      | Wd,lit5 | Status set for Wa $\hat{=}$ lit5                    |
| CP.B    | W,f     | Status set for f - W0 (byte)                        |
| CP.B    | Wa,Wd   | Status set for Wb $\hat{=}$ Wa (byte)               |
| CP.B    | Wd,lit5 | Status set for Wa $\hat{=}$ lit5 (byte)             |
| CP0     | Wd      | Status set for Wa $\hat{=}$ 0                       |
| CP0     | W,f     | Status set for f $\hat{=}$ 0                        |
| CP0.B   | Wd      | Status set for Wa $\hat{=}$ 0 (byte)                |
| CP0.B   | W,f     | Status set for f $\hat{=}$ 0 (byte)                 |
| CPB     | Wd,lit5 | Status set for Wa $\hat{=}$ lit5 $\hat{=}$ C        |
| CPB     | Wa,Wd   | Status set for Wb $\hat{=}$ Wa $\hat{=}$ C          |
| CPB     | W,f     | Status set for f $\hat{=}$ W0 - C                   |
| CPB.B   | Wa,Wd   | Status set for Wb $\hat{=}$ Wa $\hat{=}$ C (byte)   |
| CPB.B   | Wd,lit5 | Status set for Wa $\hat{=}$ lit5 $\hat{=}$ C (byte) |
| CPB.B   | W,f     | Status set for f $\hat{=}$ W0 - C (byte)            |
| CPSEQ   | Wa,Wd   | Skip if Wa = Wb                                     |
| CPSEQ.B | Wa,Wd   | Skip if Wa = Wb (byte)                              |
| CPSGT   | Wa,Wd   | Skip if Wa > Wb                                     |
| CPSGT.B | Wa,Wd   | Skip if Wa > Wb (byte)                              |
| CPSLT   | Wa,Wd   | Skip if Wa < Wb                                     |
| CPSLT.B | Wa,Wd   | Skip if Wa < Wb (byte)                              |
| CPSNE   | Wa,Wd   | Skip if Wa $\neq$ Wb                                |

TEST PCD

|         |                 |   |
|---------|-----------------|---|
| CPSNE.B | Wa,Wd           | Skip if Wa != Wb (byte)                   |
| DAW.B   | Wd              | Wa = decimal adjust Wa                    |
| DEC     | Wa,Wd           | Wd = Wa - 1                               |
| DEC     | f,W             | W0 = f - 1                                |
| DEC     | f,F             | f = f - 1                                 |
| DEC.B   | f,F             | f = f - 1 (byte)                          |
| DEC.B   | f,W             | W0 = f - 1 (byte)                         |
| DEC.B   | Wa,Wd           | Wd = Wa - 1 (byte)                        |
| DEC2    | Wa,Wd           | Wd = Wa - 2                               |
| DEC2    | f,W             | W0 = f - 2                                |
| DEC2    | f,F             | f = f - 2                                 |
| DEC2.B  | Wa,Wd           | Wd = Wa - 2 (byte)                        |
| DEC2.B  | f,W             | W0 = f - 2 (byte)                         |
| DEC2.B  | f,F             | f = f - 2 (byte)                          |
| DISI    | lit14           | Disable Interrupts lit14 cycles           |
| DIV.S   | Wa,Wd           | Signed 16/16-bit integer divide           |
| DIV.SD  | Wa,Wd           | Signed 16/16-bit integer divide (dword)   |
| DIV.U   | Wa,Wd           | Unsigned 16/16-bit integer divide         |
| DIV.UD  | Wa,Wd           | Unsigned 16/16-bit integer divide (dword) |
| DIVF    | Wa,Wd           | Signed 16/16-bit fractional divide        |
| DO      | lit14,a         | Do block lit14 times                      |
| DO      | Wd,a            | Do block Wa times                         |
| ED      | Wd*Wd,acc,da,db | Euclidean Distance (No Accumulate)        |
| EDAC    | Wd*Wd,acc,da,db | Euclidean Distance                        |
| EXCH    | Wa,Wd           | Swap Wa and Wb                            |
| FBCL    | Wa,Wd           | Find bit change from left (Msb) side      |
| FEX     |                 | ICD Execute                               |
| FF1L    | Wa,Wd           | Find first one from left (Msb) side       |
| FF1R    | Wa,Wd           | Find first one from right (Lsb) side      |



|        |               |                        |
|--------|---------------|------------------------|
| GOTO   | a             | GoTo                   |
| GOTO   | Wd            | GoTo [Wa]              |
| INC    | f,W           | W0 = f + 1             |
| INC    | Wa,Wd         | Wd = Wa + 1            |
| INC    | f,F           | f = f + 1              |
| INC.B  | Wa,Wd         | Wd = Wa + 1 (byte)     |
| INC.B  | f,F           | f = f + 1 (byte)       |
| INC.B  | f,W           | W0 = f + 1 (byte)      |
| INC2   | f,W           | W0 = f + 2             |
| INC2   | Wa,Wd         | Wd = Wa + 2            |
| INC2   | f,F           | f = f + 2              |
| INC2.B | f,W           | W0 = f + 2 (byte)      |
| INC2.B | f,F           | f = f + 2 (byte)       |
| INC2.B | Wa,Wd         | Wd = Wa + 2 (byte)     |
| IOR    | lit10,Wd      | Wd = lit10   Wd        |
| IOR    | f,F           | f = f   Wa             |
| IOR    | f,W           | W0 = f   Wa            |
| IOR    | Wa,lit5,Wd    | Wd = Wa. .lit5         |
| IOR    | Wa,Wb,Wd      | Wd = Wa. .Wb           |
| IOR.B  | Wa,Wb,Wd      | Wd = Wa. .Wb (byte)    |
| IOR.B  | f,W           | W0 = f   Wa (byte)     |
| IOR.B  | lit10,Wd      | Wd = lit10   Wd (byte) |
| IOR.B  | Wa,lit5,Wd    | Wd = Wa. .lit5 (byte)  |
| IOR.B  | f,F           | f = f   Wa (byte)      |
| LAC    | Wd,{lit4},acc | Acc = Wa shifted slit4 |
| LNK    | lit14         | Allocate Stack Frame   |
| LSR    | f,W           | W0 = f >> 1            |
| LSR    | Wa,lit4,Wd    | Wd = Wa >> lit4        |
| LSR    | Wa,Wd         | Wd = Wa >> 1           |

TEST PCD

|        |                    |   |
|--------|--------------------|---|
| LSR    | f,F                | $f = f \gg 1$                                     |
| LSR    | Wa,Wb,Wd           | $Wd = Wb \gg Wa$                                  |
| LSR.B  | f,W                | $W0 = f \gg 1$ (byte)                             |
| LSR.B  | f,F                | $f = f \gg 1$ (byte)                              |
| LSR.B  | Wa,Wd              | $Wd = Wa \gg 1$ (byte)                            |
| MAC    | Wd*Wd,acc,da,dc    | $Acc = Acc + Wa * Wa$ ; {prefetch}                |
| MAC    | Wd*Wc,acc,da,dc,pi | $Acc = Acc + Wa * Wb$ ; {[W13] = Acc}; {prefetch} |
| MOV    | W,f                | $f = Wa$  |
| MOV    | f,W                | $W0 = f$  |
| MOV    | f,F                | $f = f$   |
| MOV    | Wd,?               | $F = Wa$  |
| MOV    | Wa+lit,Wd          | $Wd = [Wa + Slit10]$                              |
| MOV    | ?,Wd               | $Wd = f$  |
| MOV    | lit16,Wd           | $Wd = lit16$                                      |
| MOV    | Wa,Wd              | $Wd = Wa$   |
| MOV    | Wa,Wd+lit          | $[Wd + Slit10] = Wa$                              |
| MOV.B  | lit8,Wd            | $Wd = lit8$ (byte)                                |
| MOV.B  | W,f                | $f = Wa$ (byte)                                   |
| MOV.B  | f,W                | $W0 = f$ (byte)                                   |
| MOV.B  | f,F                | $f = f$ (byte)                                    |
| MOV.B  | Wa+lit,Wd          | $Wd = [Wa + Slit10]$ (byte)                       |
| MOV.B  | Wa,Wd+lit          | $[Wd + Slit10] = Wa$ (byte)                       |
| MOV.B  | Wa,Wd              | $Wd = Wa$ (byte)                                  |
| MOV.D  | Wa,Wd              | $Wd:Wd+1 = Wa:Wa+1$                               |
| MOV.D  | Wa,Wd              | $Wd:Wd+1 = Wa:Wa+1$                               |
| MOVSAC | acc,da,dc,pi       | Move ? to ? and ? To ?                            |
| MPY    | Wd*Wc,acc,da,dc    | $Acc = Wa * Wb$                                   |
| MPY    | Wd*Wd,acc,da,dc    | Square to Acc                                     |
| MPY.N  | Wd*Wc,acc,da,dc    | $Acc = -(Wa * Wb)$                                |

|         |                    |   |
|---------|--------------------|---|
| MSC     | Wd*Wc,acc,da,dc,pi | Acc = Acc $\hat{a}$ €“ Wa*Wb              |
| MUL     | W,f                | W3:W2 = f * Wa                            |
| MUL.B   | W,f                | W3:W2 = f * Wa (byte)                     |
| MUL.SS  | Wa,Wd              | {Wd+1,Wd}= sign(Wa) * sign(Wb)            |
| MUL.SU  | Wa,Wd              | {Wd+1,Wd} = sign(Wa) * unsign(Wb)         |
| MUL.SU  | Wa,lit5,Wd         | {Wd+1,Wd}= sign(Wa) * unsign(lit5)        |
| MUL.US  | Wa,Wd              | {Wd+1,Wd} = unsign(Wa) * sign(Wb)         |
| MUL.UU  | Wa,Wd              | {Wd+1,Wd} = unsign(Wa) * unsign(Wb)       |
| MUL.UU  | Wa,lit5,Wd         | {Wd+1,Wd} = unsign(Wa) * unsign(lit5)     |
| NEG     | f,F                | f = - f                                   |
| PUSH    | Wd                 | Push Wa to TOS                            |
| PUSH.D  | Wd                 | PUSH double Wa:Wa + 1 to TOS              |
| PUSH.S  |                    | PUSH shadow registers                     |
| PWRSVAV | lit1               | Enter Power-saving mode lit1              |
| RCALL   | a                  | Call (relative)                           |
| RCALL   | Wd                 | Call Wa                                   |
| REPEAT  | lit14              | Repeat next instruction (lit14 + 1) times |
| REPEAT  | Wd                 | Repeat next instruction (Wa + 1) times    |
| RESET   |                    | Reset                                     |
| RETFIE  |                    | Return from interrupt enable              |
| RETLW   | lit10,Wd           | Return; Wa = lit10                        |
| RETLW.B | lit10,Wd           | Return; Wa = lit10 (byte)                 |
| RETURN  |                    | Return                                    |
| RLC     | Wa,Wd              | Wd = rotate left through Carry Wa         |
| RLC     | f,F                | f = rotate left through Carry f           |
| RLC     | f,W                | W0 = rotate left through Carry f          |
| RLC.B   | f,F                | f = rotate left through Carry f (byte)    |
| RLC.B   | f,W                | W0 = rotate left through Carry f (byte)   |
| RLC.B   | Wa,Wd              | Wd = rotate left through Carry Wa (byte)  |

TEST PCD

|        |               |   |
|--------|---------------|---|
| RLNC   | Wa,Wd         | Wd = rotate left (no Carry) Wa            |
| RLNC   | f,F           | f = rotate left (no Carry) f              |
| RLNC   | f,W           | W0 = rotate left (no Carry) f             |
| RLNC.B | f,W           | W0 = rotate left (no Carry) f (byte)      |
| RLNC.B | Wa,Wd         | Wd = rotate left (no Carry) Wa (byte)     |
| RLNC.B | f,F           | f = rotate left (no Carry) f (byte)       |
| RRC    | f,F           | f = rotate right through Carry f          |
| RRC    | Wa,Wd         | Wd = rotate right through Carry Wa        |
| RRC    | f,W           | W0 = rotate right through Carry f         |
| RRC.B  | f,W           | W0 = rotate right through Carry f (byte)  |
| RRC.B  | f,F           | f = rotate right through Carry f (byte)   |
| RRC.B  | Wa,Wd         | Wd = rotate right through Carry Wa (byte) |
| RRNC   | f,F           | f = rotate right (no Carry) f             |
| RRNC   | f,W           | W0 = rotate right (no Carry) f            |
| RRNC   | Wa,Wd         | Wd = rotate right (no Carry) Wa           |
| RRNC.B | f,F           | f = rotate right (no Carry) f (byte)      |
| RRNC.B | Wa,Wd         | Wd = rotate right (no Carry) Wa (byte)    |
| RRNC.B | f,W           | W0 = rotate right (no Carry) f (byte)     |
| SAC    | acc,{lit4},Wd | Wd = Acc slit 4                           |
| SAC.R  | acc,{lit4},Wd | Wd = Acc slit 4 with rounding             |
| SE     | Wa,Wd         | Wd = sign-extended Wa                     |
| SETM   | Wd            | Wd = 0xFFFF                               |
| SETM   | f,F           | W0 = 0xFFFF                               |
| SETM.B | Wd            | Wd = 0xFFFF (byte)                        |
| SETM.B | f,W           | W0 = 0xFFFF (byte)                        |
| SETM.B | f,F           | W0 = 0xFFFF (byte)                        |
| SFTAC  | acc,Wd        | Arithmetic shift Acc by (Wa)              |
| SFTAC  | acc,lit5      | Arithmetic shift Acc by Slit6             |
| SL     | f,W           | W0 = f << 1                               |

|        |            |   |
|--------|------------|---|
| SL     | Wa,Wb,Wd   | $Wd = Wa \ll Wb$                                |
| SL     | Wa,lit4,Wd | $Wd = Wa \ll \text{lit4}$                       |
| SL     | Wa,Wd      | $Wd = Wa \ll 1$                                 |
| SL     | f,F        | $f = f \ll 1$                                   |
| SL.B   | f,W        | $W0 = f \ll 1$ (byte)                           |
| SL.B   | Wa,Wd      | $Wd = Wa \ll 1$ (byte)                          |
| SL.B   | f,F        | $f = f \ll 1$ (byte)                            |
| SSTEP  |            | ICD Single Step                                 |
| SUB    | f,F        | $f = f \hat{=} W0$                              |
| SUB    | f,W        | $W0 = f \hat{=} W0$                             |
| SUB    | Wa,Wb,Wd   | $Wd = Wa \hat{=} Wb$                            |
| SUB    | Wa,lit5,Wd | $Wd = Wa \hat{=} \text{lit5}$                   |
| SUB    | acc        | $Acc = AccA \hat{=} AccB$                       |
| SUB    | lit10,Wd   | $Wd = Wd \hat{=} \text{lit10}$                  |
| SUB.B  | Wa,lit5,Wd | $Wd = Wa \hat{=} \text{lit5}$ (byte)            |
| SUB.B  | lit10,Wd   | $Wd = Wd \hat{=} \text{lit10}$ (byte)           |
| SUB.B  | f,W        | $W0 = f \hat{=} W0$ (byte)                      |
| SUB.B  | Wa,Wb,Wd   | $Wd = Wa \hat{=} Wb$ (byte)                     |
| SUB.B  | f,F        | $f = f \hat{=} W0$ (byte)                       |
| SUBB   | f,W        | $W0 = f \hat{=} W0 \hat{=} C$                   |
| SUBB   | Wa,Wb,Wd   | $Wd = Wa \hat{=} Wb \hat{=} C$                  |
| SUBB   | f,F        | $f = f \hat{=} W0 \hat{=} C$                    |
| SUBB   | Wa,lit5,Wd | $Wd = Wa \hat{=} \text{lit5} - C$               |
| SUBB   | lit10,Wd   | $Wd = Wd \hat{=} \text{lit10} \hat{=} C$        |
| SUBB.B | lit10,Wd   | $Wd = Wd \hat{=} \text{lit10} \hat{=} C$ (byte) |
| SUBB.B | Wa,Wb,Wd   | $Wd = Wa \hat{=} Wb \hat{=} C$ (byte)           |
| SUBB.B | f,F        | $f = f \hat{=} W0 \hat{=} C$ (byte)             |
| SUBB.B | Wa,lit5,Wd | $Wd = Wa \hat{=} \text{lit5} - C$ (byte)        |
| SUBB.B | f,W        | $W0 = f \hat{=} W0 \hat{=} C$ (byte)            |

TEST PCD

|          |            |  |
|----------|------------|--|
| SUBBR    | Wa,lit5,Wd | Wd = lit5 $\hat{=}$ Wa - C             |
| SUBBR    | f,W        | W0 = W0 $\hat{=}$ f $\hat{=}$ C        |
| SUBBR    | f,F        | f = W0 $\hat{=}$ f $\hat{=}$ C         |
| SUBBR    | Wa,Wb,Wd   | Wd = Wa $\hat{=}$ Wb - C               |
| SUBBR.B  | f,F        | f = W0 $\hat{=}$ f $\hat{=}$ C (byte)  |
| SUBBR.B  | f,W        | W0 = W0 $\hat{=}$ f $\hat{=}$ C (byte) |
| SUBBR.B  | Wa,Wb,Wd   | Wd = Wa $\hat{=}$ Wb - C (byte)        |
| SUBBR.B  | Wa,lit5,Wd | Wd = lit5 $\hat{=}$ Wa - C (byte)      |
| SUBR     | Wa,lit5,Wd | Wd = lit5 $\hat{=}$ Wb                 |
| SUBR     | f,F        | f = W0 $\hat{=}$ f                     |
| SUBR     | Wa,Wb,Wd   | Wd = Wa $\hat{=}$ Wb                   |
| SUBR     | f,W        | W0 = W0 $\hat{=}$ f                    |
| SUBR.B   | Wa,Wb,Wd   | Wd = Wa $\hat{=}$ Wb (byte)            |
| SUBR.B   | f,F        | f = W0 $\hat{=}$ f (byte)              |
| SUBR.B   | Wa,lit5,Wd | Wd = lit5 $\hat{=}$ Wb (byte)          |
| SUBR.B   | f,W        | W0 = W0 $\hat{=}$ f (byte)             |
| SWAP     | Wd         | Wa = byte or nibble swap Wa            |
| SWAP.B   | Wd         | Wa = byte or nibble swap Wa (byte)     |
| TBLRDH   | Wa,Wd      | Wd = ROM[Wa] for odd ROM               |
| TBLRDH.B | Wa,Wd      | Wd = ROM[Wa] for odd ROM (byte)        |
| TBLRDL   | Wa,Wd      | Wd = ROM[Wa] for even ROM              |
| TBLRDL.B | Wa,Wd      | Wd = ROM[Wa] for even ROM (byte)       |
| TBLWTH   | Wa,Wd      | ROM[Wa] = Wd for odd ROM               |
| TBLWTH.B | Wa,Wd      | ROM[Wa] = Wd for odd ROM (byte)        |
| TBLWTL   | Wa,Wd      | ROM[Wa] = Wd for even ROM              |
| TBLWTL.B | Wa,Wd      | ROM[Wa] = Wd for even ROM (byte)       |
| ULNK     |            | Deallocate Stack Frame                 |
| URUN     |            | ICD Run                                |
| XOR      | Wa,Wb,Wd   | Wd = Wa $\hat{^}$ Wb                   |

|       |            |                                      |
|-------|------------|--------------------------------------|
| XOR   | f,F        | $f = f \wedge W0$                    |
| XOR   | f,W        | $W0 = f \wedge W0$                   |
| XOR   | Wa,lit5,Wd | $Wd = Wa \wedge \text{lit5}$         |
| XOR   | lit10,Wd   | $Wd = Wd \wedge \text{lit10}$        |
| XOR.B | lit10,Wd   | $Wd = Wd \wedge \text{lit10}$ (byte) |
| XOR.B | f,W        | $W0 = f \wedge W0$ (byte)            |
| XOR.B | Wa,lit5,Wd | $Wd = Wa \wedge \text{lit5}$ (byte)  |
| XOR.B | Wa,Wb,Wd   | $Wd = Wa \wedge Wb$ (byte)           |
| XOR.B | f,F        | $f = f \wedge W0$ (byte)             |
| ZE    | Wa,Wd      | $Wd = Wa \& FF$                      |

## #BANK\_DMA

Syntax: #BANK\_DMA

Elements: None

Purpose: Tells the compiler to assign the data for the next variable, array or structure into DMA bank

Examples:

```
#bank_dma
struct {
  int r_w;
  int c_w;
  long unused :2;
  long data: 4;
}a_port; //the data for a_port will be forced into memory bank
DMA
```

Example: None

Files:

Also See: None

## #BANKX

Syntax: #BANKX

Elements: None

Purpose: Tells the compiler to assign the data for the next variable, array, or structure into Bank X.

Examples:

```
#bankx
struct {
  int r_w;
  int c_d;
  long unused : 2;
  long data : 4;
} a_port;
// The data for a_port will be forced into memory bank x.
```

Example Files: None

Also See: None

## #BANKY

Syntax: #BANKY

Elements: None

Purpose: Tells the compiler to assign the data for the next variable, array, or structure into Bank Y.

Examples:

```
#banky
struct {
  int r_w;
  int c_d;
  long unused : 2;
  long data : 4;
} a_port;
// The data for a port will be forced into memory bank y.
```

Example Files: None

Also See: None



## #BIT

Syntax: `#BIT id = x.y`

Elements: ***id*** is a valid C identifier,  
***x*** is a constant or a C variable,  
***y*** is a constant 0-7 (for 8-bit PICs)  
***y*** is a constant 0-15 (for 16-bit PICs)

Purpose: A new C variable (one bit) is created and is placed in memory at byte *x* and bit *y*. This is useful to gain access in C directly to a bit in the processors special function register map. It may also be used to easily access a bit of a standard C variable.

Examples: 

```
#bit T 1 IF = 0x 84.3
...
TSBS:1IF = 0; // Clear Timer 0 interrupt flag

int result;
#bit result_odd = result.0
...
if (result_odd)
```

Example Files: [ex\\_glint.c](#)

Also See: [#BYTE](#), [#RESERVE](#), [#LOCATE](#), [#WORD](#)

## #BUILD

Syntax: `#BUILD(segment = address)`  
`#BUILD(segment = address, segment = address)`  
`#BUILD(segment = start.end)`  
`#BUILD(segment = start.end, segment = start.end)`  
`#BUILD(nosleep)`  
`#BUILD(segment = size)` : For STACK use only  
`#BUILD(ALT_INTERRUPT)`

Elements: ***segment*** is one of the following memory segments which may be assigned a location: RESET, INTERRUPT , or STACK

***address*** is a ROM location memory address. Start and end are used to specify a range in memory to be used. Start is the first ROM location and end is the last ROM location to be used.

**RESET** will move the compiler's reset vector to the specified location. **INTERRUPT** will move the compiler's interrupt service routine to the specified location. This just changes the location the compiler puts its reset and ISR, it doesn't change the actual vector of the PIC. If you specify a range that is larger than actually needed, the extra space will not be used and prevented from use by the compiler.

**STACK** configures the range (start and end locations) used for the stack, if not specified the compiler uses the last 256 bytes. The **STACK** can be specified by only using the size parameters. In this case, the compiler uses the last RAM locations on the chip and builds the stack below it.

**ALT\_INTERRUPT** will move the compiler's interrupt service routine to the alternate location, and configure the PIC to use the alternate location.

**Nosleep** is used to prevent the compiler from inserting a sleep at the end of main()

**Purpose:** When linking multiple compilation units, this directive must appear exactly the same in each compilation unit.

These directives are commonly used in bootloaders, where the reset and interrupt needs to be moved to make space for the bootloading application.

**Examples:**

```
/* assign the location where the compiler will
place the reset and interrupt vectors */
#build(reset=0x200,interrupt=0x208)

/* assign the location and fix the size of the segments
used by the compiler for the reset and interrupt vectors */
#build(reset=0x200:0x207, interrupt=0x208:0x2ff)

/* assign stack space of 512 bytes */
#build(stack=0x1E00:0x1FFF)

#build(stack= 0x300) // When Start and End locations are not
specified, the compiler uses the last RAM locations available on
the chip.
```

**Example Files:** None

**Also See:** [#LOCATE](#), [#RESERVE](#), [#ROM](#), [#ORG](#)

## #BYTE

Syntax: `#BYTE id = x`

Elements: ***id*** is a valid C identifier,  
***x*** is a C variable or a constant

Purpose: If the *id* is already known as a C variable then this will locate the variable at address *x*. In this case the variable type does not change from the original definition. If the *id* is not known a new C variable is created and placed at address *x* with the type `int` (8 bit)

Warning: In both cases memory at *x* is not exclusive to this variable. Other variables may be located at the same location. In fact when *x* is a variable, then *id* and *x* share the same memory location.

```
Examples: #byte status_register = 0x42
          #byte b_port = 0x02C8

          struct {
            short int r_w;
            short int c_d;

            int data : 6 ; } E_port;
          #byte a_port = 0x2DA
          ...
          a_port.c_d = 1;
```

Example [ex\\_glint.c](#)  
Files:

Also See: [#BIT](#), [#LOCATE](#), [#RESERVE](#), [#WORD](#)

## #CASE

Syntax: `#CASE`

Elements: None

Purpose: Will cause the compiler to be case sensitive. By default the compiler is case insensitive. When linking multiple compilation units, this directive must appear exactly the same in each compilation unit.

Warning: Not all the CCS example programs, headers and drivers have been tested with case sensitivity turned on.

Examples: `#case`

## TEST PCD

```
int STATUS;  
  
void func() {  
    int status;  
    ...  
    STATUS = status; // Copy local status to  
                    //global  
}
```

Example [ex\\_cust.c](#)

Files:

Also See: None

## \_\_DATE\_\_

Syntax: `__DATE__`

Elements: None

Purpose: This pre-processor identifier is replaced at compile time with the date of the compile in the form: "31-JAN-03"

Examples: 

```
printf("Software was compiled on ");  
printf(__DATE__);
```

Example None

Files:

Also See: None

## #DEFINE

Syntax: `#DEFINE id text`  
or  
`#DEFINE id(x,y...) text`

Elements: *id* is a preprocessor identifier, text is any text, *x,y* and so on are local preprocessor identifiers, and in this form there may be one or more identifiers separated by commas.

Purpose: Used to provide a simple string replacement of the ID with the given text from this point of the program and on.

In the second form (a C macro) the local identifiers are matched up with similar

identifiers in the text and they are replaced with text passed to the macro where it is used.

If the text contains a string of the form `#idx` then the result upon evaluation will be the parameter `id` concatenated with the string `x`.

If the text contains a string of the form `#idx#idy` then parameter `idx` is concatenated with parameter `idy` forming a new identifier.

Within the `define` text two special operators are supported:

`#x` is the stringize operator resulting in `"x"`

`x##y` is the concatenation operator resulting in `xy`

```
Examples: #define BITS 8
a=a+BITS; //same as a=a+8;

#define hi(x) (x<<4)
a=hi(a); //same as a=(a<<4);

#define isequal(a,b) (primary_##a[b]==backup_##a[b])
// usage isequal(names,5) is the same as
// (primary_names[5]==backup_names[5])

#define str(s) #s
#define part(device) #include str(device##.h)
// usage part(16F887) is the same as
// #include "16F887.h"
```

Example Files: [ex\\_stwt.c](#), [ex\\_macro.c](#)

Also See: [#UNDEF](#), [#IFDEF](#), [#IFNDEF](#)

## #DEFINEDINC

Syntax: `value = definedinc( variable );`

Parameters: ***variable*** is the name of the variable, function, or type to be checked.

Returns: A C status for the type of ***id*** entered as follows:

- 0 – not known
- 1 – typedef or enum
- 2 – struct or union type
- 3 – typemod qualifier
- 4 – function prototype



|                        |   |
|------------------------|---|
|                        | completed. Can be used as long as no EEPROM operations are performed during an ISR.   |
| HIGH_INTS=TRUE         | Use this option for high/low priority interrupts on the PIC@ 18.  |
| %f=.                   | No 0 before a decimal point on %f numbers less than 1.  |
| OVERLOAD=KEYWORD       | Overloading of functions is now supported. Requires the use of the keyword for overloading.   |
| OVERLOAD=AUTO          | Default mode for overloading.   |
| PASS_STRINGS=IN_RAM    | A new way to pass constant strings to a function by first copying the string to RAM and then passing a pointer to RAM to the function.  |
| CONST=READ_ONLY        | Uses the ANSI keyword CONST definition, making CONST variables read only, rather than located in program memory.  |
| CONST=ROM              | Uses the CCS compiler traditional keyword CONST definition, making CONST variables located in program memory.   |
| NESTED_INTERRUPTS=TRUE | Enables interrupt nesting for PIC24, dsPIC30, and dsPIC33 devices. Allows higher priority interrupts to interrupt lower priority interrupts.  |
| NORETFIE               | ISR functions (preceded by a #int_XXX) will use a RETURN opcode instead of the RETFIE opcode. This is not a commonly used option; used rarely in cases where the user is writing their own ISR handler. |

Both chip and options are optional, so multiple #DEVICE lines may be used to fully define the device. Be warned that a #DEVICE with a chip identifier, will clear all previous #DEVICE and #FUSE settings.

#### **Compilation mode selection-**

The #DEVICE directive supports compilation mode selection. The valid keywords are CCS2, CCS3, CCS4 and ANSI. The default mode is CCS4. For the CCS4 and ANSI mode, the compiler uses the default fuse settings NOLVP, PUT for chips with these fuses. The NOWDT fuse is default if no call is made to restart\_wdt().

|              |   |
|--------------|---|
| CCS4         | This is the default compilation mode.   |
| ANSI         | Default data type is SIGNED all other modes default is UNSIGNED. Compilation is case sensitive, all other modes are case insensitive. |
| CCS2<br>CCS3 | var16 = NegConst8 is compiled as: var16 = NegConst8 & 0xff (no sign extension) . The overload keyword is required.                    |

CCS2 only      The default #DEVICE ADC is set to the resolution of the part, all other modes default to 8.  
 onebit = eightbits is compiled as onebit = (eightbits != 0)  
 All other modes compile as: onebit = (eightbits & 1)

Purpose:      **Chip Options** -Defines the target processor. Every program must have exactly one #DEVICE with a chip. When linking multiple compilation units, this directive must appear exactly the same in each compilation unit.

**Compilation mode selection** - The compilation mode selection allows existing code to be compiled without encountering errors created by compiler compliance. As CCS discovers discrepancies in the way expressions are evaluated according to ANSI, the change will generally be made only to the ANSI mode and the next major CCS release.

Examples:      **Chip Options-**  

```
#device DSPIC33FJ64GP306
#device PIC24FJ64GA002 ICD=TRUE
#device ADC=10
#device ICD=TRUE ADC=10
```

**Float Options-**  

```
#device %f=.
printf("%f",.5); //will print .5, without the directive it will print 0.5
```

**Compilation mode selection-**  

```
#device CCS2
```

Example      None  
 Files:

Also See:      None

## \_\_DEVICE\_\_

Syntax:      \_\_DEVICE\_\_

Elements:      None

Purpose:      This pre-processor identifier is defined by the compiler with the base number of the current device (from a #DEVICE). The base number is usually the number after the C in the part number. For example the PIC16C622 has a base number of 622.

Examples:      

```
#if __device__==71
SETUP_ADC_PORTS( ALL_DIGITAL );
#endif
```



Example        None  
Files:

Also See:     [#DEVICE](#)

## #ERROR

Syntax:        **#ERROR *text***  
                 **#ERROR / warning *text***  
                 **#ERROR / information *text***

Elements:     ***text*** is optional and may be any text

Purpose:        Forces the compiler to generate an error at the location this directive appears in the file. The text may include macros that will be expanded for the display. This may be used to see the macro expansion. The command may also be used to alert the user to an invalid compile time situation.

Examples:     

```
#if BUFFER_SIZE>16
#error Buffer size is too large
#endif
#error Macro test: min(x,y)
```

Example        [ex\\_dsp.c](#)  
Files:

Also See:     [#WARNING](#)

## #EXPORT (options)

Syntax:        #EXPORT (options)

Elements:     ***FILE=filename***  
The filename which will be generated upon compile. If not given, the filename will be the name of the file you are compiling, with a .o or .hex extension (depending on output format).

***ONLY=symbol+symbol+.....+symbol***

Only the listed symbols will be visible to modules that import or link this relocatable object file. If neither ONLY or EXCEPT is used, all symbols are exported.

***EXCEPT=symbol+symbol+.....+symbol***

All symbols except the listed symbols will be visible to modules that import or link this relocatable object file. If neither ONLY or EXCEPT is used, all symbols are exported.

**RELOCATABLE**

CCS relocatable object file format. Must be imported or linked before loading into a PIC. This is the default format when the #EXPORT is used.

**HEX**

Intel HEX file format. Ready to be loaded into a PIC. This is the default format when no #EXPORT is used.

**RANGE=start:stop**

Only addresses in this range are included in the hex file.

**OFFSET=address**

Hex file address starts at this address (0 by default)

**ODD**

Only odd bytes place in hex file.

**EVEN**

Only even bytes placed in hex file.

**Purpose:** This directive will tell the compiler to either generate a relocatable object file or a stand-alone HEX binary. A relocatable object file must be linked into your application, while a stand-alone HEX binary can be programmed directly into the PIC. The command line compiler and the PCW IDE Project Manager can also be used to compile/link/build modules and/or projects. Multiple #EXPORT directives may be used to generate multiple hex files. this may be used for 8722 like devices with external memory.

**Examples:**

```
#EXPORT(RELOCATABLE, ONLY=TimerTask)
void TimerFunc1(void) { /* some code */ }
void TimerFunc2(void) { /* some code */ }
void TimerFunc3(void) { /* some code */ }
void TimerTask(void)
{
    TimerFunc1();
    TimerFunc2();
    TimerFunc3();
}
/*
This source will be compiled into a relocatable object, but the
object this is being linked to can only see TimerTask()
*/
```

**Example Files:** None

**See Also:** [#IMPORT](#), [#MODULE](#), [Invoking the Command Line Compiler](#), [Linker Overview](#)

## \_\_FILE\_\_

Syntax: \_\_FILE\_\_

Elements: None

Purpose: The pre-processor identifier is replaced at compile time with the file path and the filename of the file being compiled.

Examples: 

```
if(index>MAX_ENTRIES)
    printf("Too many entries, source file: "
           "__FILE__ " at line " __LINE__ "\r\n");
```

Example Files: [assert.h](#)

Also See: [line](#)

## \_\_FILENAME\_\_

Syntax: \_\_FILENAME\_\_

Elements: None

Purpose: The pre-processor identifier is replaced at compile time with the filename of the file being compiled.

Examples: 

```
if(index>MAX_ENTRIES)
    printf("Too many entries, source file: "
           "__FILENAME__ " at line " __LINE__ "\r\n");
```

Example Files: None

Also See: [line](#)

## **#FILL\_ROM**

Syntax: **#fill\_rom *value***

Elements: ***value*** is a constant 16-bit value

Purpose: This directive specifies the data to be used to fill unused ROM locations. When linking multiple compilation units, this directive must appear exactly the same in each

compilation unit.

Examples: `#fill_rom 0x36`

Example Files: None

Also See: [#ROM](#)

## #FUSES

Syntax: `#FUSES options`

Elements: ***options*** vary depending on the device. A list of all valid options has been put at the top of each devices .h file in a comment for reference. The PCW device edit utility can modify a particular devices fuses. The PCW pull down menu VIEW | Valid fuses will show all fuses with their descriptions.

Some common options are:

- LP, XT, HS, RC
- WDT, NOWDT
- PROTECT, NOPROTECT
- PUT, NOPUT (Power Up Timer)
- BROWNOUT, NOBROWNOUT

Purpose: This directive defines what fuses should be set in the part when it is programmed. This directive does not affect the compilation; however, the information is put in the output files. If the fuses need to be in Parallax format, add a PAR option. SWAP has the special function of swapping (from the Microchip standard) the high and low BYTES of non-program data in the Hex file. This is required for some device programmers.

Some fuses are set by the compiler based on other compiler directives. For example, the oscillator fuses are set up by the #USE delay directive. The debug, No debug and ICSPN Fuses are set by the #DEVICE ICD=directive.

Some processors allow different levels for certain fuses. To access these levels, assign a value to the fuse.

When linking multiple compilation units be aware this directive applies to the final object file. Later files in the import list may reverse settings in previous files.

To eliminate all fuses in the output files use:

```
#FUSES none
```

To manually set the fuses in the output files use:

```
#FUSES 1 = 0xC200 // sets config word 1 to 0xC200
```

Examples: #fuses HS, NOWDT

Example: None

Files:

Also See: None

## #HEXCOMMENT

Syntax: #HEXCOMMENT text comment for the top of the hex file  
#HEXCOMMENT\ text comment for the end of the hex file

Elements: None

Purpose: Puts a comment in the hex file

Some programmers (MPLAB in particular) do not like comments at the top of the hex file.

Examples: #HEXCOMMENT Version 3.1 – requires 20MHz crystal

Example: None

Files:

Also See: None

## #ID

Syntax: #ID *number 32*  
#ID *number, number, number, number*  
#ID "*filename*"  
#ID *CHECKSUM*

Elements: **Number 32** is a 32 bit number, **number** is a 8 bit number, filename is any valid PC filename and **checksum** is a keyword.

Purpose: This directive defines the ID word to be programmed into the part. This directive does not affect the compilation but the information is put in the output file.

The first syntax will take a 32 -bit number and put one byte in each of the four ID bytes in the traditional manner. The second syntax specifies the exact value to be used in

each of the four ID bytes .

When a filename is specified the ID is read from the file. The format must be simple text with a CR/LF at the end. The keyword CHECKSUM indicates the device checksum should be saved as the ID.

```
Examples: #id 0x12345678
          #id 0x12, 0x34, 0x45, 0x67
          #id "serial.num"
          #id CHECKSUM
```

Example [ex\\_cust.c](#)  
Files:

Also See: None

## #IF expr #ELSE #ELIF #ENDIF

```
Syntax:  #if expr
         code
         #elif expr //Optional, any number may be used
         code
         #else //Optional
         code
         #endif
```

Elements: **expr** is an expression with constants, standard operators and/or preprocessor identifiers. **Code** is any standard c source code.

Purpose: The pre-processor evaluates the constant expression and if it is non-zero will process the lines up to the optional #ELSE or the #ENDIF.

Note: you may NOT use C variables in the #IF. Only preprocessor identifiers created via #define can be used.

The preprocessor expression DEFINED(id) may be used to return 1 if the id is defined and 0 if it is not.

== and != operators now accept a constant string as both operands. This allows for compile time comparisons and can be used with GETENV() when it returns a string result.

```
Examples: #if MAX_VALUE > 255
          long value;
          #else
          int value;
          #endif
          #if getenv("DEVICE")== "PIC16F877"
```

```
//do something special for the PIC16F877
#endif
```

Example [ex\\_extee.c](#)

Files:

Also See: [#IFDEF](#), [#IFNDEF](#), [getenv\(\)](#)

## #IFDEF #IFNDEF #ELSE #ELIF #ENDIF

Syntax: **#IFDEF** *id*  
**code**  
**#ELIF**  
**code**  
**#ELSE**  
**code**  
**#ENDIF**

**#IFNDEF** *id*  
**code**  
**#ELIF**  
**code**  
**#ELSE**  
**code**  
**#ENDIF**

Elements: **id** is a preprocessor identifier, **code** is valid C source code.

Purpose: This directive acts much like the #IF except that the preprocessor simply checks to see if the specified ID is known to the preprocessor (created with a #DEFINE). #IFDEF checks to see if defined and #IFNDEF checks to see if it is not defined.

Examples: 

```
#define debug      // Comment line out for no debug

...
#ifdef DEBUG
printf("debug point a");
#endif
```

Example [ex\\_sqw.c](#)

Files:

Also See: [#IF](#)

## #IGNORE\_WARNINGS

Syntax:            `#ignore_warnings ALL`  
                   `#IGNORE_WARNINGS NONE`  
                   `#IGNORE_WARNINGS warnings`

Elements:         *warnings* is one or more warning numbers separated by commas

Purpose:            This function will suppress warning messages from the compiler. ALL indicates no warning will be generated. NONE indicates all warnings will be generated. If numbers are listed then those warnings are suppressed.

Examples:         `#ignore_warnings 203`  
                   `while(TRUE) {`  
                   `#ignore_warnings NONE`

Example           None

Files:

Also See:         [Warning messages](#)

## #IMPORT (options)

Syntax:            `#IMPORT (options)`

Elements:         ***FILE=filename***  
                   The filename of the object you want to link with this compilation.

***ONLY=symbol+symbol+.....+symbol***  
                   Only the listed symbols will imported from the specified relocatable object file. If neither ONLY or EXCEPT is used, all symbols are imported.

***EXCEPT=symbol+symbol+.....+symbol***  
                   The listed symbols will not be imported from the specified relocatable object file. If neither ONLY or EXCEPT is used, all symbols are imported.

***RELOCATABLE***  
                   CCS relocatable object file format. This is the default format when the #IMPORT is used.

***COFF***  
                   COFF file format from MPASM, C18 or C30.

***HEX***  
                   Imported data is straight hex data.



**RANGE=start:stop**

Only addresses in this range are read from the hex file.

**LOCATION=id**

The identifier is made a constant with the start address of the imported data.

**SIZE=id**

The identifier is made a constant with the size of the imported data.

**Purpose:** This directive will tell the compiler to include (link) a relocatable object with this unit during compilation. Normally all global symbols from the specified file will be linked, but the EXCEPT and ONLY options can prevent certain symbols from being linked. The command line compiler and the PCW IDE Project Manager can also be used to compile/link/build modules and/or projects.

**Examples:**

```
#IMPORT(FILE=timer.o, ONLY=TimerTask)
void main(void)
{
    while(TRUE)
        TimerTask();
}
/*
timer.o is linked with this compilation, but only TimerTask() is
visible in scope from this object.
*/
```

**Example Files:** None

**See Also:** [#EXPORT](#), [#MODULE](#), [Invoking the Command Line Compiler](#), Linker Overview

## #INCLUDE

**Syntax:** #INCLUDE <filename>  
or  
#INCLUDE "filename"

**Elements:** **filename** is a valid PC filename. It may include normal drive and path information. A file with the extension ".encrypted" is a valid PC file. The standard compiler #INCLUDE directive will accept files with this extension and decrypt them as they are read. This allows include files to be distributed without releasing the source code.

**Purpose:** Text from the specified file is used at this point of the compilation. If a full path is not specified the compiler will use the list of directories specified for the project to search for the file. If the filename is in "" then the directory with the main source file is searched first. If the filename is in <> then the directory with the main source file is searched last.

## TEST PCD

Examples: `#include <16C54.H>`  
`#include <C:\INCLUDES\COMLIB\MYRS232.C>`

Example Files: [ex\\_sqw.c](#)

Also See: None

## #INLINE

Syntax: `#INLINE`

Elements: None

Purpose: Tells the compiler that the function immediately following the directive is to be implemented INLINE. This will cause a duplicate copy of the code to be placed everywhere the function is called. This is useful to save stack space and to increase speed. Without this directive the compiler will decide when it is best to make procedures INLINE.

Examples: 

```
#inline
swapbyte(int &a, int &b) {
    int t;
    t=a;
    a=b;
    b=t;
}
```

Example Files: [ex\\_cust.c](#)

Also See: [#SEPARATE](#)

## #INT\_XXXX

Elements: NoCear, LEVEL=n, HIGH, FAST, ALT

Purpose: These directives specify the following function is an interrupt function. Interrupt functions may not have any parameters. Not all directives may be used with all parts. See the devices .h file for all valid interrupts for the part or in PCW use the pull down VIEW | Valid Ints

The MPU will jump to the function when the interrupt is detected. The compiler will

generate code to save and restore the machine state, and will clear the interrupt flag. To prevent the flag from being cleared add NOCLEAR after the #INT\_xxxx. The application program must call ENABLE\_INTERRUPTS(INT\_xxxx) to initially activate the interrupt.

An interrupt marked FAST uses the shadow feature to save registers. Only one interrupt may be marked fast. Any registers used in the FAST interrupt beyond the shadow registers is the responsibility of the user to save and restore.

Level=n specifies the level of the interrupt.

Enable\_interrupts specifies the levels that are enabled. The default is level 0 and level 7 is never disabled. High is the same as level = 7.

A summary of the different kinds of dsPIC/PIC24 interrupts:

#INT\_xxxx

Normal (low priority) interrupt. Compiler saves/restores key registers.

This interrupt will not interrupt any interrupt in progress.

#INT\_xxxx FAST

Compiler does a FAST save/restore of key registers.

Only one is allowed in a program.

#INT\_xxxx HIGHLevel=3

Interrupt is enabled when levels 3 and below are enabled.

#INT\_GLOBAL

Compiler generates no interrupt code. User function is located

at address 8 for user interrupt handling.

#INT\_xxxx ALT

Interrupt is placed in Alternate Interrupt Vector instead of Default Interrupt Vector.

```
Examples: #int_ad
adc_handler() {
    adc_active=FALSE;
}

#int_timer1 noclear
ISR() {
    ...
}
```

Example None  
Files:

Also See: enable\_interrupts(), disable\_interrupts(), [#INT\\_DEFAULT](#),

## #INT\_DEFAULT

Syntax: #INT\_DEFAULT

Elements: None

Purpose: The following function will be called if the ds PIC® triggers an interrupt and a #INT\_xxx hadler has not been defined for the interrupt.

Examples: 

```
#int_default
default_isr() {
    printf("Unexplained interrupt\r\n");
}
```

Example None

Files:

Also See: #INT\_xxxx,

## \_\_LINE\_\_

Syntax: \_\_line\_\_

Elements: None

Purpose: The pre-processor identifier is replaced at compile time with line number of the file being compiled.

Examples: 

```
if(index>MAX_ENTRIES)
    printf("Too many entries, source file: "
        __FILE__ " at line " __LINE__ "\r\n");
```

Example [assert.h](#)

Files:

Also See: [\\_\\_file\\_\\_](#)

## #LIST

Syntax: #LIST

Elements: None

Purpose: #LIST begins inserting or resumes inserting source lines into the .LST file after a #NOLIST.

Examples: 

```
#NOLIST // Don't clutter up the list file
#include <cdriver.h>
#LIST
```

Example [16c74.h](#)

Files:

Also See: [#NOLIST](#)

## #LINE

Syntax: #LINE number file name

Elements: Number is non-negative decimal integer. File name is optional.

Purpose: The C pre-processor informs the C Compiler of the location in your source code. This code is simply used to change the value of `_LINE_` and `_FILE_` variables.

Examples:

```

1. void main(){
    #line 10    // specifies the line number that
               // should be reported for
               // the following line of input

2. #line 7 "hello.c"
    // line number in the source file
    // hello.c and it sets the
    // line 7 as current line
    // and hello.c as current file

```

Example: None

Files:

Also See: None

## #LOCATE

Syntax: #LOCATE *id*=*x*

Elements: *id* is a C variable,  
*x* is a constant memory address

Purpose: #LOCATE allocates a C variable to a specified address. If the C variable was not previously defined, it will be defined as an INT8.

A special form of this directive may be used to locate all A functions local variables starting at a fixed location.

Use: #LOCATE Auto = address

This directive will place the indirected C variable at the requested address.

Examples:

```

// This will locate the float variable at 50-53
// and C will not use this memory for other
// variables automatically located.
float x;
#locate x=0x 800

```

Example: [ex\\_glint.c](#)

Files:

Also See: [#BYTE](#), [#BIT](#), [#RESERVE](#), [#WORD](#)

## #MODULE

Syntax: #MODULE

Elements: None

**Purpose:** All global symbols created from the #MODULE to the end of the file will only be visible within that same block of code (and files #INCLUDE within that block). This may be used to limit the scope of global variables and functions within include files. This directive also applies to pre-processor #defines.  
**Note:** The extern and static data qualifiers can also be used to denote scope of variables and functions as in the standard C methodology. #MODULE does add some benefits in that pre-processor #DEFINE can be given scope, which cannot normally be done in standard C methodology.

**Examples:**

```
int GetCount(void);
void SetCount(int newCount);
#MODULE
int g_count;
#define G_COUNT_MAX 100
int GetCount(void) {return(g_count);}
void SetCount(int newCount) {
    if (newCount>G_COUNT_MAX)
        newCount=G_COUNT_MAX;
    g_count=newCount;
}
/*
the functions GetCount() and SetCount() have global scope, but the
variable g_count and the #define G_COUNT_MAX only has scope to this
file.
*/
```

Example Files: None

See Also: [#EXPORT](#), [Invoking the Command Line Compiler](#), [Linker Overview](#)

## #NOLIST

Syntax: #NOLIST

Elements: None

**Purpose:** Stops inserting source lines into the .LST file (until a #LIST)

**Examples:**

```
#NOLIST // Don't clutter up the list file
#include <cdriver.h>
#LIST
```

Example Files: [16c74.h](#)

Also See: [#LIST](#)

## #OCS

|           |   |
|-----------|---|
| Syntax:   | #OCS <i>x</i>   |
| Elements: | <i>x</i> is the clock's speed and can be 1 Hz to 100 MHz.   |
| Purpose:  | Used instead of the #use delay(clock = <i>x</i> )   |
| Examples: | <pre>#include &lt;18F4520.h&gt; #device ICD=TRUE #OCS 20 MHz #use rs232(debugger)  void main() {     -----; }</pre> |

Example Files: None

Also See: [#USE DELAY](#)

## #OPT

|                |   |
|----------------|---|
| Syntax:        | #OPT <i>n</i>   |
| Elements:      | All dsPIC30/dsPIC33/PIC24 Devices: <i>n</i> is the optimization level 0-9   |
| Purpose:       | The optimization level is set with this directive. This setting applies to the entire program and may appear anywhere in the file. The default is 9 for full optimization. Levels 10 and 11 are for extended optimization. It may be used to reduce optimization below default if it is suspected that an optimization is causing a flaw in the code. |
| Examples:      | #opt 5  |
| Example Files: | None  |
| Also See:      | None  |

## #ORG

|         |  |
|---------|--|
| Syntax: | #ORG <i>start, end</i><br>or<br>#ORG <i>segment</i><br>or<br>#ORG <i>start, end {}</i><br>or |
|---------|--|

```
#ORG start, end auto=0
#ORG start,end DEFAULT
  or
#ORG DEFAULT
```

Elements: ***start*** is the first ROM location (word address) to use, ***end*** is the last ROM location, ***segment*** is the start ROM location from a previous #ORG

Purpose: This directive will fix the following function or constant declaration into a specific ROM area. End may be omitted if a segment was previously defined if you only want to add another function to the segment.

Follow the ORG with a *{}* to only reserve the area with nothing inserted by the compiler.

The RAM for a ORG'ed function may be reset to low memory so the local variables and scratch variables are placed in low memory. This should only be used if the ORG'ed function will not return to the caller. The RAM used will overlap the RAM of the main program. Add a AUTO=0 at the end of the #ORG line.

If the keyword DEFAULT is used then this address range is used for all functions user and compiler generated from this point in the file until a #ORG DEFAULT is encountered (no address range). If a compiler function is called from the generated code while DEFAULT is in effect the compiler generates a new version of the function within the specified address range.

When linking multiple compilation units be aware this directive applies to the final object file. It is an error if any #ORG overlaps between files unless the #ORG matches exactly.

```
Examples: #ORG 0x1E00, 0x1FFF
MyFunc() {
//This function located at 1E00
}

#ORG 0x1E00
Anotherfunc(){
// This will be somewhere 1E00-1F00
}

#ORG 0x800, 0x820 {}
//Nothing will be at 800-820

#ORG 0x1C00, 0x1C0F
CHAR CONST ID[10]= {"123456789"};
//This ID will be at 1C00
//Note some extra code will
//proceed the 123456789

#ORG 0x1F00, 0x1FF0
Void loader (){
.
```



```

.
.
}

```

Example [loader.c](#)

Files:

Also See: [#ROM](#)

## \_\_PCD\_\_

Syntax: `__PCD__`

Elements: None

Purpose: The PCD compiler defines this pre-processor identifier. It may be used to determine if the PCD compiler is doing the compilation.

Examples: 

```
#ifdef __pcd__
#device dsPIC33FJ256MC710
#endif
```

Example [ex\\_sqw.c](#)

Files:

Also See: None

## #PRAGMA

Syntax: `#PRAGMA cmd`

Elements: ***cmd*** is any valid preprocessor directive.

Purpose: This directive is used to maintain compatibility between C compilers. This compiler will accept this directive before any other pre-processor command. In no case does this compiler require this directive.

Examples: 

```
#pragma device PIC16C54
```

Example [ex\\_cust.c](#)

Files:

Also See: None

## #RECURSIVE

Syntax: `#RECURSIVE`

Elements: None

Purpose: Tells the compiler that the procedure immediately following the directive will be recursive.

Examples:

```
#recursive
int factorial(int num) {
    if (num <= 1)
        return 1;
    return num * factorial(num-1);
}
```

Example Files: None

Also See: None

## #RESERVE

Syntax: `#RESERVE address`  
or  
`#RESERVE address, address, address`  
or  
`#RESERVE start.end`

Elements: ***address*** is a RAM address, ***start*** is the first address and ***end*** is the last address

Purpose: This directive allows RAM locations to be reserved from use by the compiler. #RESERVE must appear after the #DEVICE otherwise it will have no effect. When linking multiple compilation units be aware this directive applies to the final object file.

Examples:

```
#DEVICE dsPIC30F2010
#RESERVE 0x800:0x80B3
```

Example Files: [ex\\_cust.c](#)

Also See: [#ORG](#)

## #ROM

Syntax:        #ROM **address** = {*list*}  
                   #ROM int8 **address** = {*list*}  
                   #ROM char **address** = {*list*}

Elements:      **address** is a ROM word address, **list** is a list of words separated by commas

Purpose:         Allows the insertion of data into the .HEX file. In particular, this may be used to program the '84 data EEPROM, as shown in the following example.

Note that if the #ROM address is inside the program memory space, the directive creates a segment for the data, resulting in an error if a #ORG is over the same area. The #ROM data will also be counted as used program memory space.

The int8 option indicates each item is 8 bits, the default is 16 bits. The char option treats each item as 7 bits packing 2 chars into every pcm 14-bit word.

When linking multiple compilation units be aware this directive applies to the final object file.

Some special forms of this directive may be used for verifying program memory:

#ROM address = checksum  
       This will put a value at address such that the entire program memory will sum to 0x1248

#ROM address = crc16  
       This will put a value at address that is a crc16 of all the program memory except the specified address

#ROM address = crc8  
       This will put a value at address that is a crc16 of all the program memory except the specified address

Examples:      #rom 0x7FFC00={1,2,3,4,5,6,7,8}

Example Files:   None

Also See:        [#ORG](#)

## #SEPARATE

Syntax:        #SEPARATE options

Elements:      **options** is optional, and are:

STDCALL – Use the standard Microchip calling method, used in C30. W0-W7 is used for function parameters, rest of the working registers are not touched, remaining function parameters are pushed onto the stack.

ARG=Wx:Wy – Use the working registers Wx to Wy to hold function parameters. Any remaining function parameters are pushed onto the stack.

DND=Wx:Wy – Function will not change Wx to Wy working registers.

AVOID=Wx:Wy – Function will not use Wx to Wy working registers for function parameters.

NO RETURN - Prevents the compiler generated return at the end of a function.

You cannot use STDCALL with the ARG, DND or AVOID parameters.

If you do not specify one of these options, the compiler will determine the best configuration, and will usually not use the stack for function parameters (usually scratch space is allocated for parameters).

Purpose:        Tells the compiler that the procedure IMMEDIATELY following the directive is to be implemented SEPARATELY. This is useful to prevent the compiler from automatically making a procedure INLINE. This will save ROM space but it does use more stack space. The compiler will make all procedures marked SEPARATE, separate, as requested, even if there is not enough stack space to execute.

Examples:      

```
#separate ARG=W0:W7 AVOID=W8:W15 DND=W8:W15
swapbyte (int *a, int *b) {
int t;
    t=*a;
    *a=*b;
    *b=t;
}
```

Example        [ex\\_cust.c](#)

Files:

Also See:      [#INLINE](#)

## #SERIALIZE

Syntax: `#SERIALIZE(id=xxx, next="x" | file="filename.txt" | listfile="filename.txt", prompt="text", log="filename.txt") -`

Or-`#SERIALIZE(dataee=x, binary=x, next="x" | file="filename.txt" | listfile="filename.txt", prompt="text", log="filename.txt")`

Elements: **id=xxx** - Specify a C CONST identifier, may be int8, int16, int32 or char array

Use in place of id parameter, when storing serial number to EEPROM:

**dataee=x** - The address x is the start address in the data EEPROM.

**binary=x** - The integer x is the number of bytes to be written to address specified. -or-

**string=x** - The integer x is the number of bytes to be written to address specified.

Use only one of the next three options:

**file="filename.txt"** - The file x is used to read the initial serial number from, and this file is updated by the ICD programmer. It is assumed this is a one line file with the serial number. The programmer will increment the serial number.

**listfile="filename.txt"** - The file x is used to read the initial serial number from, and this file is updated by the ICD programmer. It is assumed this is a file one serial number per line. The programmer will read the first line then delete that line from the file.

**next="x"** - The serial number X is used for the first load, then the hex file is updated to increment x by one.

Other optional parameters:

**prompt="text"** - If specified the user will be prompted for a serial number on each load.

If used with one of the above three options then the default value the user may use is picked according to the above rules.

**log=xxx** - A file may optionally be specified to keep a log of the date, time, hex file name and serial number each time the part is programmed. If no id=xxx is specified then this may be used as a simple log of all loads of the hex file.

Purpose: Assists in making serial numbers easier to implement when working with CCS ICD units. Comments are inserted into the hex file that the ICD software interprets.

```
Examples: //Prompt user for serial number to be placed
//at address of serialNumA
//Default serial number = 200int8 const serialNumA=100;
#serialize(id=serialNumA,next="200",prompt="Enter the serial number")

//Adds serial number log in seriallog.txt
#serialize(id=serialNumA,next="200",prompt="Enter the serial number",
log="seriallog.txt")

//Retrieves serial number from serials.txt
```

```
#serialize(id=serialNumA,listfile="serials.txt")

//Place serial number at EEPROM address 0, reserving 1 byte
#serialize(dataee=0,binary=1,next="45",prompt="Put in Serial number")

//Place string serial number at EEPROM address 0, reserving 2 bytes
#serialize(dataee=0, string=2,next="AB",prompt="Put in Serial
number")
```

Example      None

Files:

Also See:    None

## #TASK

(The RTOS is only included with the PCW, PCWH, and PCWHD software packages.)

Each RTOS task is specified as a function that has no parameters and no return. The #TASK directive is needed just before each RTOS task to enable the compiler to tell which functions are RTOS tasks. An RTOS task cannot be called directly like a regular function can.

Syntax:      #TASK (*options*)

Elements:    *options* are separated by comma and may be:

- rate=time  
Where time is a number followed by s, ms, us, or ns. This specifies how often the task will execute.
- max=time  
Where time is a number followed by s, ms, us, or ns. This specifies the budgeted time for this task.
- queue=bytes  
Specifies how many bytes to allocate for this task's incoming messages. The default value is 0.
- enabled=value  
Specifies whether a task is enabled or disabled by rtos\_run( ). True for enabled, false for disabled. The default value is enabled.

Purpose:      This directive tells the compiler that the following function is an RTOS task.

The rate option is used to specify how often the task should execute. This must be a multiple of the minor\_cycle option if one is specified in the #USE RTOS directive.

The max option is used to specify how much processor time a task will use in one

execution of the task. The time specified in max must be equal to or less than the time specified in the minor\_cycle option of the #USE RTOS directive before the project will compile successfully. The compiler does not have a way to enforce this limit on processor time, so a programmer must be careful with how much processor time a task uses for execution. This option does not need to be specified.

The queue option is used to specify the number of bytes to be reserved for the task to receive messages from other tasks or functions. The default queue value is 0.

Examples: `#task(rate=1s, max=20ms, queue=5)`

Also See: [#USE RTOS](#)

## \_\_TIME\_\_

Syntax: `__TIME__`

Elements: None

Purpose: This pre-processor identifier is replaced at compile time with the time of the compile in the form: "hh:mm:ss"

Examples: 

```
printf("Software was compiled on ");
printf( TIME );
```

Example None

Files:

Also See: None

## #TYPE

Syntax: `#TYPE standard-type=size`  
`#TYPE default=area`  
`#TYPE unsigned`  
`#TYPE signed`  
`#TYPE char=signed`  
`#TYPE char=unsigned`  
`#TYPE ARG=Wx:Wy`  
`#TYPE DND=Wx:Wy`  
`#TYPE AVOID=Wx:Wy`  
`#TYPE RECURSIVE`  
`#TYPE CLASSIC`

Elements: **standard-type** is one of the C keywords short, int, long, float, or double  
**size** is 1,8,16, 48, or 64  
**area** is a memory region defined before the #TYPE using the addressmod directive  
Wx:Wy is a range of working registers (example: W0, W1, W15, etc)

Purpose: By default the compiler treats SHORT as 8 bits , INT as 16 bits, and LONG as 32 bits.

The traditional C convention is to have INT defined as the most efficient size for the target processor. This is why it is 16 bits on the dsPIC/PIC24®. In order to help with code compatibility a #TYPE directive may be used to allow these types to be changed. #TYPE can redefine these keywords.

Note that the commas are optional. Be warned CCS example programs and include files may not work right if you use #TYPE in your program.

Classic will set the type sizes to be compatible with CCS PIC programs.

This directive may also be used to change the default RAM area used for variable storage. This is done by specifying default=area where area is a addressmod address space.

When linking multiple compilation units be aware this directive only applies to the current compilation unit.

The #TYPE directive allows the keywords UNSIGNED and SIGNED to set the default data type.

The ARG parameter tells the compiler that all functions can use those working registers to receive parameters. The DND parameters tells the compiler that all functions should not change those working registers (not use them for scratch space). The AVOID parameter tells the compiler to not use those working registers for passing variables to functions. If you are using recursive functions, then it will use the stack for passing variables when there is not enough working registers to hold variables; if you are not using recursive functions, the compiler will allocate scratch space for holding variables if there is not enough working registers. #SEPARATE can be used to set these parameters on an individual basis.

The RECURSIVE option tells the compiler that ALL functions can be recursive. #RECURSIVE can also be used to assign this status on an individual basis.

```
Examples: #TYPE    SHORT= 1 , INT= 8 , LONG= 16, FLOAT=48

#TYPE default=area

addressmod (user_ram_block, 0x100, 0x1FF);

#type default=user_ram_block // all variable declarations
                             // in this area will be in
                             // 0x100-0x1FF

#type default=                // restores memory allocation
                             // back to normal

#TYPE SIGNED

#TYPE RECURSIVE
#TYPE ARG=W0:W7
```



```
#TYPE AVOID=W8:W15
#TYPE DND=W8:W15

...
void main()
{
int variable1; // variable1 can only take values from -128 to 127
...
...
}
```

Example: [ex\\_cust.c](#)  
Files:  
Also See: None

## #UNDEF

Syntax: **#UNDEF *id***

Elements: ***id*** is a pre-processor id defined via #DEFINE

Purpose: The specified pre-processor ID will no longer have meaning to the pre-processor.

Examples: 

```
#if MAXSIZE<100
#undef MAXSIZE
#define MAXSIZE 100
#endif
```

Example Files: None

Also See: [#DEFINE](#)

## #USE DELAY

Syntax: **#USE DELAY (options)**

Elements: Options may be any of the following separated by commas:

***clock=*speed** speed is a constant 1-100000000 (1 hz to 100 mhz). This number can contains commas. This number also supports the following denominations: M, MHZ, K, KHZ. This specifies the clock the CPU runs at. Depending on the PIC this is 2 or 4 times the instruction rate. This directive is not needed if the following ***type=*speed** is used and there is no frequency multiplication or division.

***type=*speed** type defines what kind of clock you are using, and the following values are

valid: oscillator, osc (same as oscillator), crystal, xtal (same as crystal), internal, int (same as internal) or rc. The compiler will automatically set the oscillator configuration bits based upon your defined type. If you specified internal, the compiler will also automatically set the internal oscillator to the defined speed. Configuration fuses are modified when this option is used. Speed is the input frequency.

**restart\_wdt** will restart the watchdog timer on every `delay_us()` and `delay_ms()` use.

**AUX: type=speed** Some chips have a second oscillator used by specific peripherals and when this is the case this option sets up that oscillator.

Also See: [delay\\_ms\(\)](#), [delay\\_us\(\)](#)

## #USE DYNAMIC\_MEMORY

Syntax: `#USE DYNAMIC_MEMORY`

Elements: **None**

Purpose: This pre-processor directive instructs the compiler to create the `_DYNAMIC_HEAD` object. `_DYNAMIC_HEAD` is the location where the first free space is allocated.

Examples: 

```
#USE DYNAMIC_MEMORY
void main ( ) {
}
```

Example Files: [ex\\_malloc.c](#)

Also See: None

## #USE FAST\_IO

Syntax: `#USE FAST_IO (port)`

Elements: ***port*** is A, B, C, D, E, F, G, H, J or ALL

Purpose: Affects how the compiler will generate code for input and output instructions that follow. This directive takes effect until another `#use xxxx_IO` directive is encountered. The fast method of doing I/O will cause the compiler to perform I/O without programming of the direction register. The compiler's default operation is the opposite of this command, the direction I/O will be set/cleared on each I/O operation. The user must ensure the direction register is set correctly via `set_tris_X()`. When linking multiple compilation units be aware this directive only applies to the current compilation unit.

Examples: `#use fast_io(A)`

Example Files: [ex\\_cust.c](#)

Also See: [#USE FIXED\\_IO](#), [#USE STANDARD\\_IO](#), [set\\_tris\\_X\(\)](#), [General Purpose I/O](#)

## #USE FIXED\_IO

Syntax: `#USE FIXED_IO (port_outputs=pin, pin?)`

Elements: ***port*** is A-G, ***pin*** is one of the pin constants defined in the devices .h file.

Purpose: This directive affects how the compiler will generate code for input and output instructions that follow. This directive takes effect until another #USE XXX\_IO directive is encountered. The fixed method of doing I/O will cause the compiler to generate code to make an I/O pin either input or output every time it is used. The pins are programmed according to the information in this directive (not the operations actually performed). This saves a byte of RAM used in standard I/O. When linking multiple compilation units be aware this directive only applies to the current compilation unit.

Examples: `#use fixed_io(a_outputs=PIN_A2, PIN_A3)`

Example Files: None

Also See: [#USE FAST\\_IO](#), [#USE STANDARD\\_IO](#), [General Purpose I/O](#)

## #USE I2C

Syntax: `#USE I2C (options)`

Elements: ***Options*** are separated by commas and may be:

|              |  |
|--------------|--|
| MASTER       | Sets to the master mode                      |
| MULTI_MASTER | Set the multi_master mode                    |
| SLAVE        | Set the slave mode                           |
| SCL=pin      | Specifies the SCL pin (pin is a bit address) |
| SDA=pin      | Specifies the SDA pin                        |
| ADDRESS=nn   | Specifies the slave mode address             |
| FAST         | Use the fast I2C specification.              |
| FAST=nnnnnn  | Sets the speed to nnnnnn hz                  |
| SLOW         | Use the slow I2C specification               |
| RESTART_WDT  | Restart the WDT while waiting in I2C_READ    |

|              |  |
|--------------|--|
| FORCE_HW     | Use hardware I2C functions.  |
| FORCE_SW     | Use software I2C functions.  |
| NOFLOAT_HIGH | Does not allow signals to float high, signals are driven from low to high  |
| SMBUS        | Bus used is not I2C bus, but very similar  |
| STREAM=id    | Associates a stream identifier with this I2C port. The identifier may then be used in functions like <code>i2c_read</code> or <code>i2c_write</code> . |
| NO_STRETCH   | Do not allow clock stretching  |
| MASK=nn      | Set an address mask for parts that support it  |
| I2C1         | Instead of <code>SCL=</code> and <code>SDA=</code> this sets the pins to the first module  |
| I2C2         | Instead of <code>SCL=</code> and <code>SDA=</code> this sets the pins to the second module   |

Only some chips allow the following:

|              |  |
|--------------|--|
| DATA_HOLD    | No ACK is sent until <code>I2C_READ</code> is called for data bytes (slave only)       |
| ADDRESS_HOLD | No ACK is sent until <code>I2C_read</code> is called for the address byte (slave only) |
| SDA_HOLD     | Min of 300ns holdtime on SDA a from SCL goes low                                       |

**Purpose:** CCS offers support for the hardware-based I2C™ and a software-based master I2C™ device. (For more information on the hardware-based I2C module, please consult the datasheet for your target device; not all PICs support I2C™.)

The I2C library contains functions to implement an I2C bus. The `#USE I2C` remains in effect for the `I2C_START`, `I2C_STOP`, `I2C_READ`, `I2C_WRITE` and `I2C_POLL` functions until another `USE I2C` is encountered. Software functions are generated unless the `FORCE_HW` is specified. The SLAVE mode should only be used with the built-in SSP. The functions created with this directive are exported when using multiple compilation units. To access the correct function use the stream identifier.

**Examples:**

```
#use I2C(master, sda=PIN_B0, scl=PIN_B1)

#use I2C(slave, sda=PIN_C4, scl=PIN_C3
         address=0xa0, FORCE_HW)

#use I2C(master, scl=PIN_B0, sda=PIN_B1, fast=450000)
//sets the target speed to 450 KBSP
```

**Example Files:** [ex\\_extee.c](#) with [16c74.h](#)

**Also See:** [i2c\\_poll](#), [i2c\\_speed](#), [i2c\\_start](#), [i2c\\_stop](#), [i2c\\_slaveaddr](#), [i2c\\_isr\\_state](#), [i2c\\_write](#), [i2c\\_read](#), [I2C Overview](#)

## #USE RS232

Syntax: #USE RS232 (*options*)

|           |  |   |
|-----------|--|---|
| Elements: | <b>Options</b> are separated by commas and may be: |   |
|           | STREAM=id  | Associates a stream identifier with this RS232 port. The identifier may then be used in functions like fputc.   |
|           | BAUD=x   | Set baud rate to x  |
|           |  | NOINIT option:<br><br>Use baud=0 to not init the UART and pins C6 and C7 can still be used for input-output functions.<br><br>#USE RS232(baud=0,options)<br><br>To make printf work with NOINIT option, use:<br><br>setup_uart(9600); |
|           | XMIT=pin   | Set transmit pin  |
|           | RCV=pin  | Set receive pin   |
|           | FORCE_SW   | Will generate software serial I/O routines even when the UART pins are specified.   |
|           | BRGH1OK  | Allow bad baud rates on chips that have baud rate problems.   |
|           | ENABLE=pin   | The specified pin will be high during transmit. This may be used to enable 485 transmit.  |
|           | DEBUGGER   | Indicates this stream is used to send/receive data through a CCS ICD unit. The default pin used in B3, use XMIT= and RCV= to change the pin used. Both should be the same pin.  |
|           | RESTART_WDT  | Will cause GETC() to clear the WDT as it waits for a character.   |
|           | INVERT   | Invert the polarity of the serial pins (normally not needed when level converter, such as the MAX232). May not be used with the internal UART.  |
|           | PARITY=X   | Where x is N, E, or O.  |

|              |  |
|--------------|--|
| BITS =X      | Where x is 5-9 (5-7 may not be used with the SCI).   |
| FLOAT_HIGH   | The line is not driven high. This is used for open collector outputs. Bit 6 in RS232_ERRORS is set if the pin is not high at the end of the bit time.  |
| ERRORS       | Used to cause the compiler to keep receive errors in the variable RS232_ERRORS and to reset errors when they occur.  |
| SAMPLE_EARLY | A getc() normally samples data in the middle of a bit time. This option causes the sample to be at the start of a bit time. May not be used with the UART.   |
| RETURN=pin   | For FLOAT_HIGH and MULTI_MASTER this is the pin used to read the signal back. The default for FLOAT_HIGH is the XMIT pin and for MULTI_MASTER the RCV pin.   |
| MULTI_MASTER | Uses the RETURN pin to determine if another master on the bus is transmitting at the same time. If a collision is detected bit 6 is set in RS232_ERRORS and all future PUTC's are ignored until bit 6 is cleared. The signal is checked at the start and end of a bit time. May not be used with the UART. |
| LONG_DATA    | Makes getc() return an int16 and putc accept an int16. This is for 9 bit data formats.   |
| DISABLE_INTS | Will cause interrupts to be disabled when the routines get or put a character. This prevents character distortion for software implemented I/O and prevents interaction between I/O in interrupt handlers and the main program when using the UART.  |
| STOP=X       | To set the number of stop bits (default is 1). This works for both UART and non-UART ports.  |
| TIMEOUT=X    | To set the time getc() waits for a byte in milliseconds. If no character comes in within this time the RS232_ERRORS is set to 0 as well as the return value from getc(). This works for both UART and non-UART ports.  |
| SYNC_SLAVE   | Makes the RS232 line a synchronous slave, making the   |

|                 |  |
|-----------------|--|
|                 | receive pin a clock in, and the data pin the data in/out.  |
| SYNC_MASTER     | Makes the RS232 line a synchronous master, making the receive pin a clock out, and the data pin the data in/out.   |
| SYNC_MATER_CONT | Makes the RS232 line a synchronous master mode in continuous receive mode. The receive pin is set as a clock out, and the data pin is set as the data in/out.  |
| UART1           | Sets the XMIT= and RCV= to the chips first hardware UART.  |
| UART1A          | Uses alternate UART pins   |
| UART2           | Sets the XMIT= and RCV= to the chips second hardware UART.   |
| UART2A          | Uses alternate UART pins   |
| NOINIT          | No initialization of the UART peripheral is performed. Useful for dynamic control of the UART baudrate or initializing the peripheral manually at a later point in the program's run time. If this option is used, then <code>setup_uart( )</code> needs to be used to initialize the peripheral. Using a serial routine (such as <code>getc( )</code> or <code>putc( )</code> ) before the UART is initialized will cause undefined behavior. |

**Purpose:** This directive tells the compiler the baud rate and pins used for serial I/O. This directive takes effect until another RS232 directive is encountered. The `#USE DELAY` directive must appear before this directive can be used. This directive enables use of built-in functions such as `GETC`, `PUTC`, and `PRINTF`. The functions created with this directive are exported when using multiple compilation units. To access the correct function use the stream identifier.

When using parts with built-in UART and the UART pins are specified, the SCI will be used. If a baud rate cannot be achieved within 3% of the desired value using the current clock rate, an error will be generated. The definition of the `RS232_ERRORS` is as follows:

No UART:

- Bit 7 is 9th bit for 9 bit data mode (get and put).
- Bit 6 set to one indicates a put failed in float high mode.

With a UART:

- Used only by get:
- Copy of RCSTA register except:
- Bit 0 is used to indicate a parity error.

**Warning:**

The PIC UART will shut down on overflow (3 characters received by the hardware with a GETC() call). The "ERRORS" option prevents the shutdown by detecting the condition and resetting the UART.

**Examples:** `#use rs232 (baud=9600, xmit=PIN A2,rcv=PIN A3)`

**Example Files:** [ex\\_cust.c](#)

**Also See:** [getc\(\)](#), [putc\(\)](#), [printf\(\)](#), [setup\\_uart\(\)](#), [RS2332 I/O overview](#)

## #USE RTOS

(The RTOS is only included with the PCW and PCWH packages.)

The CCS Real Time Operating System (RTOS) allows a PIC micro controller to run regularly scheduled tasks without the need for interrupts. This is accomplished by a function (RTOS\_RUN()) that acts as a dispatcher. When a task is scheduled to run, the dispatch function gives control of the processor to that task. When the task is done executing or does not need the processor anymore, control of the processor is returned to the dispatch function which then will give control of the processor to the next task that is scheduled to execute at the appropriate time. This process is called cooperative multi-tasking.

**Syntax:** `#USE RTOS (options)`

|                               |   |                      |   |                               |   |                         |  |
|-------------------------------|---|----------------------|---|-------------------------------|---|-------------------------|--|
| <b>Elements:</b>              | options are separated by comma and may be:  |                      |   |                               |   |                         |  |
|                               | <table border="0"> <tr> <td style="padding-right: 20px;"><code>timer=X</code></td> <td>Where x is 0-4 specifying the timer used by the RTOS.</td> </tr> <tr> <td style="padding-right: 20px;"><code>minor_cycle=time</code></td> <td>Where time is a number followed by s, ms, us, ns. This is the longest time any task will run. Each task's execution rate must be a multiple of this time. The compiler can calculate this if it is not specified.</td> </tr> <tr> <td style="padding-right: 20px;"><code>statistics</code></td> <td>Maintain min, max, and total time used by each task.</td> </tr> </table> | <code>timer=X</code> | Where x is 0-4 specifying the timer used by the RTOS. | <code>minor_cycle=time</code> | Where time is a number followed by s, ms, us, ns. This is the longest time any task will run. Each task's execution rate must be a multiple of this time. The compiler can calculate this if it is not specified. | <code>statistics</code> | Maintain min, max, and total time used by each task. |
| <code>timer=X</code>          | Where x is 0-4 specifying the timer used by the RTOS.   |                      |   |                               |   |                         |  |
| <code>minor_cycle=time</code> | Where time is a number followed by s, ms, us, ns. This is the longest time any task will run. Each task's execution rate must be a multiple of this time. The compiler can calculate this if it is not specified.   |                      |   |                               |   |                         |  |
| <code>statistics</code>       | Maintain min, max, and total time used by each task.  |                      |   |                               |   |                         |  |

**Purpose:** This directive tells the compiler which timer on the PIC to use for monitoring and when to grant control to a task. Changes to the specified timer's prescaler will effect the rate at which tasks are executed.

This directive can also be used to specify the longest time that a task will ever take to execute with the `minor_cycle` option. This simply forces all task execution rates to be a multiple of the `minor_cycle` before the project will compile successfully. If the this option is not specified the compiler will use a `minor_cycle` value that is the smallest possible factor of the execution rates of the RTOS tasks.

If the `statistics` option is specified then the compiler will keep track of the minimum processor time taken by one execution of each task, the maximum processor time taken



by one execution of each task, and the total processor time used by each task.

When linking multiple compilation units, this directive must appear exactly the same in each compilation unit.

Examples: `#use rtos(timer=0, minor cycle=20ms)`

Also See: [#TASK](#)

## #USE SPI

Syntax: `#USE SPI (options)`

|           |  |   |
|-----------|--|---|
| Elements: | <b>Options</b> are separated by commas and may be: |   |
|           | MASTER   | Set the device as the master. (default)                             |
|           | SLAVE  | Set the device as the slave.  |
|           | BAUD=n   | Target bits per second, default is as fast as possible.             |
|           | CLOCK_HIGH=n                                       | High time of clock in us (not needed if BAUD= is used). (default=0) |
|           | CLOCK_LOW=n  | Low time of clock in us (not needed if BAUD= is used). (default=0)  |
|           | DI=pin   | Optional pin for incoming data.                                     |
|           | DO=pin   | Optional pin for outgoing data.                                     |
|           | CLK=pin  | Clock pin.  |
|           | MODE=n   | The mode to put the SPI bus.  |
|           | ENABLE=pin   | Optional pin to be active during data transfer.                     |
|           | LOAD=pin   | Optional pin to be pulsed active after data is transferred.         |
|           | DIAGNOSTIC=pin                                     | Optional pin to the set high when data is sampled.                  |
|           | SAMPLE_RISE  | Sample on rising edge.  |
|           | SAMPLE_FALL  | Sample on falling edge (default).                                   |
|           | BITS=n   | Max number of bits in a transfer. (default=32)                      |
|           | SAMPLE_COUNT=n                                     | Number of samples to take (uses majority vote). (default=1)         |
|           | LOAD_ACTIVE=n                                      | Active state for LOAD pin (0, 1).                                   |
|           | ENABLE_ACTIVE=n                                    | Active state for ENABLE pin (0, 1). (default=0)                     |
|           | IDLE=n   | Inactive state for CLK pin (0, 1). (default=0)                      |
|           | ENABLE_DELAY=n                                     | Time in us to delay after ENABLE is activated. (default=0)          |
|           | DATA_HOLD=n  | Time between data change and clock change                           |
|           | LSB_FIRST  | LSB is sent first.  |

|           |  |
|-----------|--|
| MSB_FIRST | MSB is sent first. (default)             |
| STREAM=id | Specify a stream name for this protocol. |
| SPI1      | Use the hardware pins for SPI Port 1     |
| SPI2      | Use the hardware pins for SPI Port 2     |
| FORCE_HW  | Use the pic hardware SPI.                |

**Purpose:** The SPI library contains functions to implement an SPI bus. After setting all of the proper parameters in #USE SPI, the spi\_xfer() function can be used to both transfer and receive data on the SPI bus.

The SPI1 and SPI2 options will use the SPI hardware onboard the PIC. The most common pins present on hardware SPI are: DI, DO, and CLK. These pins don't need to be assigned values through the options; the compiler will automatically assign hardware-specific values to these pins. Consult your PIC's data sheet as to where the pins for hardware SPI are. If hardware SPI is not used, then software SPI will be used. Software SPI is much slower than hardware SPI, but software SPI can use any pins to transfer and receive data other than just the pins tied to the PIC's hardware SPI pins.

The MODE option is more or less a quick way to specify how the stream is going to sample data. MODE=0 sets IDLE=0 and SAMPLE\_RISE. MODE=1 sets IDLE=0 and SAMPLE\_FALL. MODE=2 sets IDLE=1 and SAMPLE\_FALL. MODE=3 sets IDLE=1 and SAMPLE\_RISE. There are only these 4 MODEs.

SPI cannot use the same pins for DI and DO. If needed, specify two streams: one to send data and another to receive data.

The pins must be specified with DI, DO, CLK or SPIx, all other options are defaulted as indicated above.

**Examples:**

```
#use spi(DI=PIN B1, DO=PIN B0, CLK=PIN B2, ENABLE=PIN B4, BITS=16)
// uses software SPI

#use spi(FORCE_HW, BITS=16, stream=SPI_STREAM)
// uses hardware SPI and gives this stream the name SPI_STREAM
```

**Example** None  
**Files:**

**Also See:** [spi\\_xfer\(\)](#)

## #USE STANDARD\_IO

**Syntax:** #USE STANDARD\_IO (*port*)

**Elements:** *port* is A, B, C, D, E, F, G, H, J or ALL

**Purpose:** This directive affects how the compiler will generate code for input and output

instructions that follow. This directive takes effect until another #USE XXX\_IO directive is encountered. The standard method of doing I/O will cause the compiler to generate code to make an I/O pin either input or output every time it is used. On the 5X processors this requires one byte of RAM for every port set to standard I/O.

Standard\_io is the default I/O method for all ports.

When linking multiple compilation units be aware this directive only applies to the current compilation unit.

Examples: `#use standard_io(A)`

Example: [ex\\_cust.c](#)

Files:

Also See: [#USE FAST\\_IO](#), [#USE FIXED\\_IO](#), [General Purpose I/O](#)

## #USE TIMER

Syntax: `#USE TIMER (options)`

Elements: **TIMER=x**

Sets the timer to use as the tick timer. x is a valid timer that the PIC has. Default value is 1 for Timer 1.

**TICK=xx**

Sets the desired time for 1 tick. xx can be used with ns(nanoseconds), us (microseconds), ms (milliseconds), or s (seconds). If the desired tick time can't be achieved it will set the time to closest achievable time and will generate a warning specifying the exact tick time. The default value is 1us.

**BITS=x**

Sets the variable size used by the get\_ticks() and set\_ticks() functions for returning and setting the tick time. x can be 8 for 8 bits, 16 for 16 bits, 32 for 32bits or 64 for 64 bits. The default is 32 for 32 bits.

**ISR**

Uses the timer's interrupt to increment the upper bits of the tick timer. This mode requires the the global interrupt be enabled in the main program.

**NOISR**

The get\_ticks() function increments the upper bits of the tick timer. This requires that the get\_ticks() function be called more often then the timer's overflow rate. NOISR is the default mode of operation.

Purpose: This directive creates a tick timer using one of the PIC's timers. The tick timer is initialized to zero at program start. This directive also creates the define TICKS\_PER\_SECOND as a floating point number, which specifies that number of ticks that will occur in one second.

```

Examples: #USE TIMER(TIMER=1,TICK=1ms,BITS=16,NOISR)

unsigned int16 tick_difference(unsigned int16 current, unsigned int16
previous) {
    return(current - previous);
}

void main(void) {
    unsigned int16 current_tick, previous_tick;
    current_tick = previous_tick = get_ticks();
    while(TRUE) {
        current_tick = get_ticks();
        if(tick_difference(current_tick, previous_tick) > 1000) {
            output_toggle(PIN_B0);
            previous_tick = current_tick;
        }
    }
}

```

Example      None

Files:

Also See:    [get\\_ticks\(\)](#), [set\\_ticks\(\)](#)

## #USE TOUCHPAD

Syntax:      #USE TOUCHPAD (options)

Elements:    **RANGE=x**  
Sets the oscillator charge/discharge current range. If x is L, current is nominally 0.1 microamps. If x is M, current is nominally 1.2 microamps. If x is H, current is nominally 18 microamps. Default value is H (18 microamps).

**THRESHOLD=x**  
x is a number between 1-100 and represents the percent reduction in the nominal frequency that will generate a valid key press in software. Default value is 6%.

**SCANTIME=xxMS**  
xx is the number of milliseconds used by the microprocessor to scan for one key press. If utilizing multiple touch pads, each pad will use xx milliseconds to scan for one key press. Default is 32ms.

**PIN=char**  
If a valid key press is determined on "PIN", the software will return the character "char" in the function touchpad\_getc(). (Example: PIN\_B0='A')

Purpose:      This directive will tell the compiler to initialize and activate the Capacitive Sensing Module (CSM) on the microcontroller. The compiler requires use of the TIMER0 and TIMER1 modules, and global interrupts must still be activated in the main program in

order for the CSM to begin normal operation. For most applications, a higher RANGE, lower THRESHOLD, and higher SCANTIME will result better key press detection. Multiple PIN's may be declared in "options", but they must be valid pins used by the CSM. The user may also generate a TIMER0 ISR with TIMER0's interrupt occurring every SCANTIME milliseconds. In this case, the CSM's ISR will be executed first.

```
Examples: #USE TOUCHPAD (THRESHOLD=5, PIN D5='5', PIN B0='C')
void main(void){
    char c;
    enable_interrupts(GLOBAL);

    while(1){
        c = TOUCHPAD_GETC(); //will wait until a pin is detected
    }                       //if PIN_B0 is pressed, c will have 'C'
    }                       //if PIN_D5 is pressed, c will have '5'
```

Example None

Files:

Also See: [touchpad\\_state\(\)](#), [touchpad\\_getc\(\)](#), [touchpad\\_hit\(\)](#)

## #WARNING

Syntax: #WARNING **text**

Elements: **text** is optional and may be any text

Purpose: Forces the compiler to generate a warning at the location this directive appears in the file. The text may include macros that will be expanded for the display. This may be used to see the macro expansion. The command may also be used to alert the user to an invalid compile time situation.

```
Examples: #if BUFFER_SIZE < 32
#warning Buffer Overflow may occur
#endif
```

Example [ex\\_psp.c](#)

Files:

Also See: [#ERROR](#)

## #WORD

Syntax: #WORD **id = x**

Elements: **id** is a valid C identifier,

**x** is a C variable or a constant

Purpose: If the id is already known as a C variable then this will locate the variable at address

x. In this case the variable type does not change from the original definition. If the id is not known a new C variable is created and placed at address x with the type int16

Warning: In both cases memory at x is not exclusive to this variable. Other variables may be located at the same location. In fact when x is a variable, then id and x share the same memory location.

```
Examples: #word data = 0x0860

struct {
    short C;
    short Z;
    short OV;
    short N;
    short RA;
    short IPL0;
    short IPL1;
    short IPL2;
    int upperByte : 8;
} status_register;
#word status_register = 0x42
...
short zero = status_register.Z;
```

Example None

Files:

Also See: [#BIT](#), [#BYTE](#), [#LOCATE](#), [#RESERVE](#)

## #ZERO\_RAM

Syntax: #ZERO\_RAM

Elements: None

Purpose: This directive zero's out all of the internal registers that may be used to hold variables before program execution begins.

```
Examples: #zero_ram
void main() {

}
```

Example [ex\\_cust.c](#)

Files:

Also See: None

# BUILT-IN FUNCTIONS DIRECTORY



C Compiler

## BUILT-IN-FUNCTIONS

The CCS compiler provides a lot of built-in functions to access and use the pic microcontroller's peripherals. This makes it very easy for the users to configure and use the peripherals without going into in depth details of the registers associated with the functionality. The functions categorized by the peripherals associated with them are listed on the next page. Click on the function name to get a complete description and parameter and return value descriptions.

|                  |                                 |                                   |                                  |                                 |
|------------------|---------------------------------|-----------------------------------|----------------------------------|---------------------------------|
| RS232 I/O        | <a href="#">assert()</a>        | <a href="#">getch()</a>           | <a href="#">putc()</a>           |                                 |
|                  | <a href="#">fgetc()</a>         | <a href="#">getchar()</a>         | <a href="#">putchar()</a>        |                                 |
|                  | <a href="#">fgets()</a>         | <a href="#">gets()</a>            | <a href="#">puts()</a>           |                                 |
|                  | <a href="#">fprintf()</a>       | <a href="#">kbhit()</a>           | <a href="#">setup_uart()</a>     |                                 |
|                  | <a href="#">fputc()</a>         | <a href="#">perror()</a>          | <a href="#">set_uart_speed()</a> |                                 |
|                  | <a href="#">fputs()</a>         | <a href="#">printf()</a>          | <a href="#">getc()</a>           |                                 |
|                  |                                 |                                   |                                  |                                 |
| SPI TWO WIRE I/O | <a href="#">setup_spi()</a>     | <a href="#">spi_data_is_in()</a>  | <a href="#">spi_read()</a>       | <a href="#">spi_write()</a>     |
|                  | <a href="#">setup_spi2()</a>    | <a href="#">spi_data_is_in2()</a> | <a href="#">spi_read2()</a>      | <a href="#">spi_write2()</a>    |
|                  | <a href="#">spi_xfer()</a>      |                                   |                                  |                                 |
|                  |                                 |                                   |                                  |                                 |
| DISCRETE I/O     | <a href="#">get_tris_x()</a>    | <a href="#">input_x()</a>         | <a href="#">output_float()</a>   | <a href="#">output_low()</a>    |
|                  | <a href="#">input()</a>         | <a href="#">output_x()</a>        | <a href="#">output_high()</a>    | <a href="#">output_toggle()</a> |
|                  | <a href="#">input_state()</a>   | <a href="#">output_bit()</a>      | <a href="#">output_drive()</a>   | <a href="#">set_pullup()</a>    |
|                  | <a href="#">set_tris_x()</a>    | <a href="#">input_change_x()</a>  |                                  |                                 |
|                  |                                 |                                   |                                  |                                 |
| I2C I/O          | <a href="#">i2c_isr_state()</a> | <a href="#">i2c_slaveaddr()</a>   | <a href="#">i2c_write()</a>      |                                 |
|                  | <a href="#">i2c_poll()</a>      | <a href="#">i2c_start()</a>       | <a href="#">i2c_stop()</a>       |                                 |
|                  | <a href="#">i2c_read()</a>      | <a href="#">i2c_speed()</a>       |                                  |                                 |

## TEST PCD

|                       |                                      |                                 |                                 |                            |
|-----------------------|--------------------------------------|---------------------------------|---------------------------------|----------------------------|
| PROCESSOR CONTROLS    | <code>clear_interrupt()</code>       | <code>goto_address()</code>     | <code>setup_oscillator()</code> |                            |
|                       | <code>disable_interrupts()</code>    | <code>interrupt_active()</code> | <code>sleep()</code>            |                            |
|                       | <code>enable_interrupts()</code>     | <code>label_address()</code>    |                                 |                            |
|                       | <code>ext_int_edge()</code>          | <code>reset_cpu()</code>        |                                 |                            |
|                       | <code>getenv()</code>                | <code>restart_cause()</code>    |                                 |                            |
| BIT/BYTE MANIPULATION | <code>bit_clear()</code>             | <code>bit_last()</code>         | <code>_mul()</code>             | <code>shift_right()</code> |
|                       | <code>bit_set()</code>               | <code>make8()</code>            | <code>rotate_left()</code>      | <code>swap()</code>        |
|                       | <code>bit_test()</code>              | <code>make16()</code>           | <code>rotate_right()</code>     |                            |
|                       | <code>bit_first()</code>             | <code>make32()</code>           | <code>shift_left()</code>       |                            |
|                       |                                      |                                 |                                 |                            |
| STANDARD C MATH       | <code>abs()</code>                   | <code>atoi32()</code>           | <code>floor()</code>            | <code>modf()</code>        |
|                       | <code>acos()</code>                  | <code>atoi48()</code>           | <code>fmod()</code>             | <code>pow()</code>         |
|                       | <code>asin()</code>                  | <code>ceil()</code>             | <code>frexp()</code>            | <code>pwr()</code>         |
|                       | <code>atan()</code>                  | <code>cos()</code>              | <code>labs()</code>             | <code>sin()</code>         |
|                       | <code>atan2()</code>                 | <code>cosh()</code>             | <code>ldexp()</code>            | <code>sinh()</code>        |
|                       | <code>atof()</code>                  | <code>div()</code>              | <code>ldiv()</code>             | <code>sqrt()</code>        |
|                       | <code>atof48()</code>                | <code>exp()</code>              | <code>log()</code>              | <code>tan()</code>         |
|                       | <code>atof64()</code>                | <code>fabs()</code>             | <code>log10()</code>            | <code>tanh()</code>        |
|                       |                                      |                                 |                                 |                            |
|                       |                                      |                                 |                                 |                            |
|                       |                                      |                                 |                                 |                            |
| VOLTAGE REF/COMPARE   | <code>setup_low_volt_detect()</code> | <code>setup_vref()</code>       | <code>setup_comparator()</code> |                            |
| A/D CONVERSION        | <code>adc_done()</code>              | <code>set_adc_channel()</code>  | <code>read_adc()</code>         |                            |
|                       | <code>adc_done2()</code>             | <code>set_adc_channel2()</code> | <code>read_adc2()</code>        |                            |
|                       | <code>setup_adc()</code>             | <code>setup_adc_ports()</code>  |                                 |                            |
|                       | <code>setup_adc2()</code>            | <code>setup_adc_ports2()</code> |                                 |                            |



STANDARD  
C CHAR /  
STRING

|               |                |            |             |
|---------------|----------------|------------|-------------|
| atof( )       | islower(char)  | strcmp( )  | strchr( )   |
| atoi( )       | isprint(x)     | strcoll( ) | strspn( )   |
| atol( )       | ispunct(x)     | strcpy( )  | strstr( )   |
| isalnum( )    | isspace(char)  | strcspn( ) | strtod( )   |
| isalpha(char) | isupper(char)  | strlen( )  | strtok( )   |
| isamong( )    | isxdigit(char) | strlwr( )  | strtol( )   |
| iscntrl(x)    | itoa( )        | strncat( ) | strtoul( )  |
| isdigit(char) | sprintf( )     | strncmp( ) | strxfrm( )  |
| isgraph(x)    | strcat( )      | strncpy( ) | tolower( )  |
| strerror( )   | strpbrk( )     | stricmp( ) | toupper( )  |
| strchr( )     | strcpy( )      | strtof( )  | strtof48( ) |

## TIMERS

|                |                 |              |
|----------------|-----------------|--------------|
| get_timerx( )  | set_timerx( )   | setup_wdt( ) |
| get_timerxy( ) | set_timerxy( )  | get_ticks( ) |
| restart_wdt( ) | setup_timerx( ) | set_ticks( ) |

STANDARD  
C MEMORY

|            |             |                |
|------------|-------------|----------------|
| calloc( )  | memcmp( )   | offsetofbit( ) |
| free( )    | memcpy( )   | realloc( )     |
| longjmp( ) | memmove( )  | setjmp( )      |
| malloc( )  | memset( )   |                |
| memchr( )  | offsetof( ) |                |

CAPTURE/  
COMPARE/  
PWM

|                    |                        |                         |
|--------------------|------------------------|-------------------------|
| set_pwm_duty( )    | set_compare_time( )    | setup_power_pwm( )      |
| set_motor_unit( )  | setup_compare( )       | setup_power_pwm_pins( ) |
| setup_motor_pwm( ) | get_motor_pwm_count( ) | get_capture( )          |
| setup_capture( )   | set_motor_pwm_duty( )  | set_motor_pwm_event( )  |

## TEST PCD

|                     |   |   |   |                        |
|---------------------|---|---|---|------------------------|
| NON-VOLATILE MEMORY | erase_program_memory()<br>read_eeprom()<br>read_configuration_memory()<br>read_rom_memory() | read_program_memory()<br>write_configuration_memory()<br>write_eeprom()<br>write_program_memory() |   |                        |
| STANDARD C SPECIAL  | bsearch()<br>nargs()  | qsort()<br>rand()   | srand()<br>va_arg()                             | va_end()<br>va_start() |
| DELAYS              | delay_cycles()  | delay_ms()  | delay_us()                                      |                        |
| RTOS                | rtos_await()<br>rtos_disable()<br>rtos_enable()<br>rtos_msg_poll()<br>rtos_msg_read()       | rtos_msg_send()<br>rtos_overrun()<br>rtos_run()<br>rtos_signal()<br>rtos_stats()                  | rtos_terminate()<br>rtos_wait()<br>rtos_yield() |                        |
| DSP                 | TBD   |   |   |                        |
| DMA                 | dma_status()  | dma_start()   | setup_dma()                                     |                        |
| QEI                 | qei_get_count()<br>setup_qei()  | qei_set_count()   | qei_status()                                    |                        |
| DCI                 | dci_data_received()<br>dci_transmit_ready()   | dci_read()<br>dci_write()   | dci_start()<br>setup_dci()                      |                        |

|                         |  |  |  |
|-------------------------|--|--|--|
| RTC                     | rtc_alarm_read()<br>rtc_read()   | rtc_alarm_write()<br>rtc_write()   | setup_rtc_alarm()<br>setup_rtc()                   |
| CRC                     | crc_calc(mode)<br>crc_calc8()  | crc_init(mode)   | setup_crc(mode)                                    |
| D/A<br>CONVERSION       | dac_write()<br>setup_high_speed_adc_pair()   | setup_dac()<br>high_speed_adc_done()   | setup_high_speed_adc()<br>read_high_speed_adc()    |
| CAPACITIVE<br>TOUCH PAD | touchpad_getc()  | touchpad_hit()   | touchpad_state()                                   |
| EXTENDED<br>RAM         | write_extended_ram()   | read_extended_ram()  |  |
| PARALLEL<br>PORT        | pmp_address(address)<br>pmp_overflow()<br>psp_input_full()<br>psp_read()<br>setup_pmp(option,<br>address_mask) | pmp_input_full()<br>pmp_read()<br>psp_output_full()<br>psp_write()<br>setup_psp(option,<br>address_mask) | pmp_output_full()<br>pmp_write()<br>psp_overflow() |

## abs()

Syntax: `value = abs(x)`

Parameters: `x` is any integer or float type.

Returns: Same type as the parameter.

Function: Computes the absolute value of a number.

Availability: All devices

|                |  |
|----------------|--|
| Requires:      | <code>#INCLUDE &lt;stdlib.h&gt;</code>                               |
| Examples:      | <pre>signed int target,actual; ... error = abs(target-actual);</pre> |
| Example Files: | None   |
| Also See:      | <a href="#">labs()</a>   |

## adc\_done( ) adc\_done2( )

Syntax:                   value = adc\_done();  
                          value = adc\_done2( );

|                |   |
|----------------|---|
| Parameters:    | None  |
| Returns:       | A short int. TRUE if the A/D converter is done with conversion, FALSE if it is still busy.  |
| Function:      | Can be polled to determine if the A/D has valid data.   |
| Availability:  | Only available on devices with built in analog to digital converters  |
| Requires:      | None  |
| Examples:      | <pre>int16 value; setup_adc_ports(sAN0 sAN1, VSS_VDD); setup_adc(ADC_CLOCK_DIV_4 ADC_TAD_MUL_8); set_adc_channel(0); read_adc(ADC_START_ONLY);  int1 done = adc_done(); while(!done) {     done = adc_done(); } value = read_adc(); printf("A/C value = %LX\n\r", value); }</pre> |
| Example Files: | None  |
| Also See:      | <a href="#">setup_adc()</a> , <a href="#">set_adc_channel()</a> , <a href="#">setup_adc_ports()</a> , <a href="#">read_adc()</a> , <a href="#">ADC Overview</a>   |

## assert( )

|                |  |
|----------------|--|
| Syntax:        | assert ( <b>condition</b> );   |
| Parameters:    | <b>condition</b> is any relational expression  |
| Returns:       | Nothing  |
| Function:      | This function tests the condition and if FALSE will generate an error message on STDERR (by default the first USE RS232 in the program). The error message will include the file and line of the assert(). No code is generated for the assert() if you #define NODEBUG. In this way you may include asserts in your code for testing and quickly eliminate them from the final program. |
| Availability:  | All devices  |
| Requires:      | assert.h and #USE RS232  |
| Examples:      | <pre>assert( number_of_entries&lt;TABLE_SIZE );  // If number_of_entries is &gt;= TABLE_SIZE then // the following is output at the RS232: // Assertion failed, file myfile.c, line 56</pre>   |
| Example Files: | None   |
| Also See:      | <a href="#">#USE RS232</a> , <a href="#">RS232 I/O Overview</a>  |

## atof( )

|               |  |
|---------------|--|
| Syntax:       | write_program_memory( <b>address</b> , <b>dataptr</b> , <b>count</b> );  |
| Parameters:   | <b>string</b> is a pointer to a null terminated string of characters.  |
| Returns:      | Result is a floating point number  |
| Function:     | Converts the string passed to the function into a floating point representation. If the result cannot be represented, the behavior is undefined. This function also handles E format numbers . |
| Availability: | All devices  |
| Requires:     | #INCLUDE <stdlib.h>  |

## TEST PCD

Examples:

```
char string [10];
float32 x;

strcpy (string, "12E3");
x = atof(string);
// x is now 12000.00
```

Example Files: None

Files:

Also See: [atoi\(\)](#), [atol\(\)](#), [atoi32\(\)](#), [atof\(\)](#), [printf\(\)](#)

## atof( ) atof48( ) atof64( )

Syntax:

```
result = atof (string)
or
result = atof48(string)
or
result=atof64(string)
```

Parameters: **string** is a pointer to a null terminated string of characters.

Returns: Result is a floating point number in single, extended or double precision format

Function: Converts the string passed to the function into a floating point representation. If the result cannot be represented, the behavior is undefined.

Availability: All devices

Requires: #INCLUDE <stdlib.h>

Examples:

```
char string [10];
float x;

strcpy (string, "123.456");
x = atof(string);
// x is now 123.456
```

Example Files: [ex\\_tank.c](#)

Files:

Also See: [atoi\(\)](#), [atol\(\)](#), [atoi32\(\)](#), [printf\(\)](#)

## atoi( ) atol( ) atoi32( ) atoi48( ) atoi64( )

|                |   |
|----------------|---|
| Syntax:        | <pre> ivalue = atoi(<b>string</b>) or lvalue = atol(<b>string</b>) or i32value = atoi32(<b>string</b>) or i48value=atoi48(<b>string</b>) or i64value=atoi64(<b>string</b>) </pre>     |
| Parameters:    | <b>string</b> is a pointer to a null terminated string of characters.   |
| Returns:       | <pre> ivalue is an 8 bit int. lvalue is a 16 bit int. i32value is a 32 bit int. 48value is a 48 bit int. i64value is a 64 bit int. </pre>   |
| Function:      | Converts the string passed to the function into an int representation. Accepts both decimal and hexadecimal argument. If the result cannot be represented, the behavior is undefined. |
| Availability:  | All devices   |
| Requires:      | #INCLUDE <stdlib.h>   |
| Examples:      | <pre> char string[10]; int x;  strcpy(string, "123"); x = atoi(string); // x is now 123 </pre>  |
| Example Files: | <a href="#">input.c</a>   |
| Also See:      | <a href="#">printf()</a>  |

## bit\_clear( )

|             |  |
|-------------|--|
| Syntax:     | bit_clear( <b>var, bit</b> )   |
| Parameters: | <pre> <b>var</b> may be a any bit variable (any lvalue) <b>bit</b> is a number 0- 63 representing a bit number, 0 is the least significant bit. </pre> |
| Returns:    | undefined  |
| Function:   | Simply clears the specified bit in the given   |

|                |   |
|----------------|---|
|                | variable. The least significant bit is 0. This function is the similar to: <code>var &amp;= ~(1&lt;&lt;bit);</code> |
| Availability:  | All devices   |
| Requires:      | Nothing   |
| Examples:      | <pre>int x; x=5; bit_clear(x,2); // x is now 1</pre>  |
| Example Files: | <a href="#">ex_patg.c</a>   |
| Also See:      | <a href="#">bit_set()</a> , <a href="#">bit_test()</a>  |

## bit\_first( )

|                       |   |
|-----------------------|---|
| <b>Syntax:</b>        | <code>N = bit_first (value, var)</code>   |
| <b>Parameters:</b>    | <b>value</b> is a 0 to 1 to be shifted in<br><b>var</b> is a 16 bit integer.  |
| <b>Returns:</b>       | An 8 bit integer  |
| <b>Function:</b>      | This function sets N to the 0 based position of the first occurrence of value. The search starts from the right or least significant bit. |
| <b>Availability:</b>  | 30F/33F/24-bit devices  |
| <b>Requires:</b>      | Nothing   |
| <b>Examples:</b>      | <pre>Int16 var = 0x0033; Int8 N = 0; // N = 2 N = bit_first (0, var);</pre>   |
| <b>Example Files:</b> | None  |
| <b>Also See:</b>      | <a href="#">shift_right()</a> , <a href="#">shift_left()</a> , <a href="#">rotate_right()</a> , <a href="#">rotate_left()</a>             |

## bit\_last( )

|                    |  |
|--------------------|--|
| <b>Syntax:</b>     | <code>N = bit_last (value, var)</code><br><code>N = bit_last(var)</code>                                 |
| <b>Parameters:</b> | <b>value</b> is a 0 to 1 to search for<br><b>var</b> is a 16 bit integer.                                |
| <b>Returns:</b>    | An 8-bit integer   |
| <b>Function:</b>   | The first function will find the first occurrence of value in the var starting with the most significant |



bit.  
The second function will note the most significant bit of var and then search for the first different bit. Both functions return a 0 based result.

**Availability:** 30F/33F/24-bit devices

**Requires:** Nothing

**Examples:**

```
//Bit pattern
//11101110 11111111
Int16 var = 0xEEFF;
Int8 N = 0;
//N is assigned 12
N = bit_last (0, var);
//N is assigned 12
N = bit_last (var);
```

**Example Files:** None

**Also See:** [shift\\_right\(\)](#), [shift\\_left\(\)](#), [rotate\\_right\(\)](#), [rotate\\_left\(\)](#)

## bit\_set( )

**Syntax:** bit\_set(*var*, *bit*)

**Parameters:** *var* may be any variable (any lvalue)

*bit* is a number 0- 63 representing a bit number, 0 is the least significant bit.

**Returns:** Undefined

**Function:** Sets the specified bit in the given variable. The least significant bit is 0. This function is the similar to: var |= (1<<bit);

**Availability:** All devices

**Requires:** Nothing

**Examples:**

```
int x;
x=5;
bit_set(x,3);
// x is now 13
```

**Example Files:** [ex\\_patg.c](#)

**Also See:** [bit\\_clear\(\)](#), [bit\\_test\(\)](#)

## bit\_test( )

**Syntax:** value = bit\_test (*var*, *bit*)

**Parameters:** *var* may be a any bit variable (any lvalue)  
*bit* is a number 0- 63 representing a bit number, 0 is the least significant bit.

**Returns:** 0 or 1

**Function:** Tests the specified bit in the given variable. The least significant bit is 0. This function is much more efficient than, but otherwise similar to:  
`((var & (1<<bit)) != 0)`

**Availability:** All devices

**Requires:** Nothing

**Examples:**

```
if( bit_test(x,3) || !bit_test (x,1) ){
    //either bit 3 is 1 or bit 1 is 0
}

if(data!=0)
    for(i=31;!bit_test(data, i);i-- ) ;
// i now has the most significant bit in data
// that is set to a 1
```

**Example Files:** [ex\\_patq.c](#)

**Also See:** [bit\\_clear\(\)](#), [bit\\_set\(\)](#)

## bsearch( )

**Syntax:** ip = bsearch  
(*&key*, *base*, *num*, *width*, *compare*)

**Parameters:** *key*: Object to search for  
*base*: Pointer to array of search data  
*num*: Number of elements in search data  
*width*: Width of elements in search data  
*compare*: Function that compares two elements in search data

**Returns:** bsearch returns a pointer to an occurrence of key in the array pointed to by base. If key is not found, the function returns NULL. If the array is not in order or contains duplicate records with identical keys, the result is unpredictable.

**Function:** Performs a binary search of a sorted array

|                |   |
|----------------|---|
| Availability:  | All devices   |
| Requires:      | #INCLUDE <stdlib.h>   |
| Examples:      | <pre>int nums[5]={1,2,3,4,5}; int compar(const void *arg1,const void *arg2);  void main() {     int *ip, key;     key = 3;     ip = bsearch(&amp;key, nums, 5, sizeof(int), compar); }  int compar(const void *arg1,const void *arg2) {     if ( * (int *) arg1 &lt; ( * (int *) arg2) return - 1     else if ( * (int *) arg1 == ( * (int *) arg2) return 0     else return 1; }</pre> |
| Example Files: | None  |
| Also See:      | <a href="#">qsort()</a>   |

## calloc ( )

|                |  |
|----------------|--|
| Syntax:        | ptr=calloc( <i>nmem</i> , <i>size</i> )  |
| Parameters:    | <b>nmem</b> is an integer representing the number of member objects, and size is the number of bytes to be allocated for each one of them.   |
| Returns:       | A pointer to the allocated memory, if any. Returns null otherwise.   |
| Function:      | The calloc function allocates space for an array of nmem objects whose size is specified by size. The space is initialized to all bits zero. |
| Availability:  | All devices  |
| Requires:      | #INCLUDE <stdlib.h>  |
| Examples:      | <pre>int * iptr; iptr=calloc(5,10); // iptr will point to a block of memory of // 50 bytes all initialized to 0.</pre>                       |
| Example Files: | None   |
| Also See:      | <a href="#">realloc()</a> , <a href="#">free()</a> , <a href="#">malloc()</a>  |

## ceil( )

Syntax: `result = ceil ( value )`

Parameters: ***value*** is any float type

Returns: A float with precision equal to ***value***

Function: Computes the smallest integer value greater than the argument. CEIL(12.67) is 13.00.

Availability: All devices

Requires: `#INCLUDE<math.h>`

Examples: 

```
// Calculate cost based on weight rounded
// up to the next pound

cost = ceil( weight ) * DollarsPerPound;
```

Example Files: None

Also See: [floor\(\)](#)

## clear\_interrupt( )

Syntax: `clear_interrupt(level)`

Parameters: **level** - a constant defined in the devices.h file

Returns: undefined

Function: Clears the interrupt flag for the given level. This function is designed for use with a specific interrupt, thus eliminating the GLOBAL level as a possible parameter. Some chips that have interrupt on change for individual pins allow the pin to be specified like INT\_RA1.

Availability: All devices

Requires: Nothing

Examples: `clear_interrupt(int_timer1);`

Example Files: None

Files:

Also See: [enable\\_interrupts](#) , [#INT](#) , [Interrupts Overview](#)

## crc\_calc( ) crc\_calc8( ) crc\_calc16( ) crc\_calc32( )

Syntax:

```

Result = crc_calc (data,[width]);
Result = crc_calc(ptr,len,[width]);
Result = crc_calc8(data,[width]);
Result = crc_calc8(ptr,len,[width]);
Result = crc_calc16(data,[width]);           //same as
crc_calc( )
Result = crc_calc16(ptr,len,[width]);       //same as
crc_calc( )
Result = crc_calc32(data,[width]);
Result = crc_calc32(ptr,len,[width]);

```

**Parameters:** **data-** This is one double word, word or byte that needs to be processed when the `crc_calc32( )`, `crc_calc16( )`, or `crc_calc8( )` is used.

**ptr-** is a pointer to one or more double words, words or bytes of data

**len-** number of double words, words or bytes to process for `crc_calc32( )`, `crc_calc16( )`, or `crc_calc8( )` function calls.

**width-** optional parameter used to specify the input data bit width to use with the `crc_calc32( )`, `crc_calc16( )`, and `crc_calc8( )` functions. Only available on devices with a 32-bit CRC peripheral. If not specified, it defaults to the width of the return value of the function, 8-bit for `crc_calc8( )`, 16-bit for `crc_calc16( )` and 32-bit for `crc_calc32( )`. For device with a 16-bit for `crc_calc16( )` and 8-bit `crc_calc8( )`.

**Returns:** Returns the result of the final CRC calculation.

**Function:** This will process one data double word, word or byte or **len** double words, words or bytes of data using the CRC engine.

**Availability:** Only the devices with built in CRC module.

**Requires:** Nothing

**Examples:**

```

int16 data[8];
Result = crc_calc(data,8);

```

**Example Files:** None

**Also See:** [setup\\_crc\(\)](#); [crc\\_init\(\)](#)

## crc\_init(mode)

Syntax: `crc_init (data);`

Parameters: ***data*** - This will setup the initial value used by write CRC shift register. Most commonly, this register is set to 0x0000 for start of a new CRC calculation.

Returns: undefined

Function: Configures the CRCWDAT register with the initial value used for CRC calculations.

Availability: Only the devices with built in CRC module.

Requires: Nothing

Examples: 

```

crc_init (); // Starts the CRC accumulator out at 0

crc_init(0xFEED); // Starts the CRC accumulator out
at 0xFEED
```

Example Files: None

Also See: [setup\\_crc\(\)](#), [crc\\_calc\(\)](#), [crc\\_calc8\(\)](#)

## dac\_write( )

Syntax: `dac_write (value)`  
`dac_write (channel, value)`

Parameters: Value: 8-bit integer value to be written to the DAC module  
Value: 16-bit integer value to be written to the DAC module  
channel: Channel to be written to. Constants are:  
DAC\_RIGHT  
DAC\_DEFAULT  
DAC\_LEFT

Returns: undefined

**Function:** This function will write a 8-bit integer to the specified DAC channel.  
This function will write a 16-bit integer to the specified DAC channel.

**Availability:** Only available on devices with built in digital to analog converters.

**Requires:** Nothing

**Examples:**

```
int i = 0;
setup_dac(DAC_VDD | DAC_OUTPUT);
while(1){
    i++;
    dac_write(i);
}
int i = 0;
setup_dac(DAC_RIGHT_ON, 5);
while(1){
    i++;
    dac_write(DAC_RIGHT | i);
}
```

**Also See:** [setup\\_dac\(\)](#), [DAC Overview](#), see header file for device selected

## dc\_i\_data\_received( )

**Syntax:** dc\_i\_data\_received()

**Parameters:** none

**Returns:** An int1. Returns true if the DCI module has received data.

**Function:** Use this function to poll the receive buffers. It acts as a kbhit() function for DCI.

**Availability:** Only available on devices with DCI

**Requires:** None

**Examples:**

```
while(1)
{
    if(dc_i_data_received())
    {
        //read data, load buffers, etc...
    }
}
```

}

|                |      |
|----------------|------|
| Example Files: | None |
|----------------|------|

|           |  |
|-----------|--|
| Also See: | <a href="#">DCI Overview</a> , <a href="#">setup_dci()</a> , <a href="#">dci_start()</a> , <a href="#">dci_write()</a> , <a href="#">dci_read()</a> , <a href="#">dci_transmit_ready()</a> |
|-----------|--|

## dci\_read( )

Syntax: `dci_read(left channel, right channel);`

|             |  |
|-------------|--|
| Parameters: | <i>left channel</i> - A pointer to a signed int16 that will hold the incoming audio data for the left channel (on a stereo system). This data is received on the bus before the right channel data (for situations where left & right channel does have meaning) |
|-------------|--|

|  |  |
|--|--|
|  | <i>right channel</i> - A pointer to a signed int16 that will hold the incoming audio data for the right channel (on a stereo system). This data is received on the bus after the data in <i>left channel</i> . |
|--|--|

|          |           |
|----------|-----------|
| Returns: | undefined |
|----------|-----------|

|           |  |
|-----------|--|
| Function: | Use this function to read two data words. Do not use this function with DMA. This function is provided mainly for applications involving a stereo codec. |
|-----------|--|

|  |  |
|--|--|
|  | If your application does not use both channels but only receives on a slot (see <code>setup_dci</code> ), use only the left channel. |
|--|--|

|               |                                    |
|---------------|------------------------------------|
| Availability: | Only available on devices with DCI |
|---------------|------------------------------------|

|           |      |
|-----------|------|
| Requires: | None |
|-----------|------|

|           |  |
|-----------|--|
| Examples: | <pre>while(1) {     dci_read(&amp;left_channel, &amp;right_channel);     dci_write(&amp;left_channel, &amp;right_channel); }</pre> |
|-----------|--|

|                |      |
|----------------|------|
| Example Files: | None |
|----------------|------|

|           |   |
|-----------|---|
| Also See: | <a href="#">DCI Overview</a> , <a href="#">setup_dci()</a> , <a href="#">dci_start()</a> , <a href="#">dci_write()</a> , <a href="#">dci_transmit_ready()</a> , <a href="#">dci_data_received()</a> |
|-----------|---|



## dc\_i\_start( )

Syntax: `dc_i_start();`

Parameters: None

Returns: undefined

Function: Starts the DCI module's transmission. DCI operates in a continuous transmission mode (unlike other transmission protocols that transmit only when they have data). This function starts the transmission. This function is primarily provided to use DCI in conjunction with DMA

Availability: Only available on devices with DCI.

Requires: None

Examples:

```
dc_i_initialize((I2S_MODE | DCI_MASTER |
DCI_CLOCK_OUTPUT | SAMPLE_RISING_EDGE |
UNDERFLOW_LAST |
MULTI_DEVICE_BUS),DCI_1WORD_FRAME |
DCI_16BIT_WORD | DCI_2WORD_INTERRUPT,
RECEIVE_SLOT0 | RECEIVE_SLOT1, TRANSMIT_SLOT0 |
TRANSMIT_SLOT1, 6000);

...

dc_i_start();
```

Example Files: None

Also See: [DCI Overview](#), [setup\\_dc\\_i\(\)](#), [dc\\_i\\_write\(\)](#), [dc\\_i\\_read\(\)](#), [dc\\_i\\_transmit\\_ready\(\)](#), [dc\\_i\\_data\\_received\(\)](#)

## dc\_i\_transmit\_ready( )

Syntax: `dc_i_transmit_ready()`

Parameters: None

Returns: An int1. Returns true if the DCI module is ready to transmit (there is space open in the hardware buffer).

Function: Use this function to poll the transmit buffers.

Availability: Only available on devices with DCI

|                |   |
|----------------|---|
| Requires:      | None  |
| Examples:      | <pre>while(1) {     if(dci_transmit_ready())     {         //transmit data, load buffers, etc...     } }</pre>  |
| Example Files: | None  |
| Also See:      | <a href="#">DCI Overview</a> , <a href="#">setup_dci()</a> , <a href="#">dci_start()</a> , <a href="#">dci_write()</a> , <a href="#">dci_read()</a> , <a href="#">dci_data_received()</a> |

## dci\_write( )

Syntax: `dci_write(left channel, right channel);`

|                |  |
|----------------|--|
| Parameters:    | <p><i>left channel</i>- A pointer to a signed int16 that holds the outgoing audio data for the left channel (on a stereo system). This data is transmitted on the bus before the right channel data (for situations where left &amp; right channel does have meaning)</p> <p><i>right channel</i>- A pointer to a signed int16 that holds the outgoing audio data for the right channel (on a stereo system). This data is transmitted on the bus after the data in <i>left channel</i>.</p> |
| Returns:       | undefined  |
| Function:      | <p>Use this function to transmit two data words. Do not use this function with DMA. This function is provided mainly for applications involving a stereo codec.</p> <p>If your application does not use both channels but only transmits on a slot (see <code>setup_dci()</code>), use only the left channel. If you transmit more than two slots, call this function multiple times.</p>  |
| Availability:  | Only available on devices with DCI   |
| Requires:      | None   |
| Examples:      | <pre>while(1) {     dci_read(&amp;left_channel, &amp;right_channel);     dci_write(&amp;left_channel, &amp;right_channel); }</pre>   |
| Example Files: | None   |
| Also See:      | <a href="#">DCI Overview</a> , <a href="#">setup_dci()</a> , <a href="#">dci_start()</a> , <a href="#">dci_read()</a> , <a href="#">dci_transmit_ready()</a> , <a href="#">dci_data_received()</a>   |

## delay\_cycles( )

Syntax: `delay_cycles (count)`

Parameters: ***count*** - a constant 1-255

Returns: undefined

Function: Creates code to perform a delay of the specified number of instruction clocks (1-255). An instruction clock is equal to four oscillator clocks.

The delay time may be longer than requested if an interrupt is serviced during the delay. The time spent in the ISR does not count toward the delay time.

Availability: All devices

Requires: Nothing

Examples: `delay_cycles( 1 ); // Same as a NOP`  
`delay_cycles(25); // At 20 mhz a 5us delay`

Example Files: [ex\\_cust.c](#)

Also See: [delay\\_us\(\)](#), [delay\\_ms\(\)](#)

## delay\_ms( )

Syntax: `delay_ms (time)`

Parameters: ***time*** - a variable 0-65535(int16) or a constant 0-65535

Note: Previous compiler versions ignored the upper byte of an int16, now the upper byte affects the time.

Returns: undefined

Function: This function will create code to perform a delay of the specified length. Time is specified in milliseconds. This function works by executing a precise number of instructions to cause the requested delay. It does not use any timers. If interrupts are enabled the time spent in an interrupt routine is not counted toward the time.

The delay time may be longer than requested if an interrupt is serviced during the delay. The time spent in the ISR does not count toward the delay time.

Availability: All devices

|                |   |
|----------------|---|
| Requires:      | <code>#USE DELAY</code>   |
| Examples:      | <pre>#use delay (clock=20000000)  delay_ms( 2 );  void delay_seconds(int n) {   for (;n!=0; n- -)     delay_ms( 1000 ); }</pre> |
| Example Files: | <a href="#">ex_sqw.c</a>  |
| Also See:      | <a href="#">delay_us()</a> , <a href="#">delay_cycles()</a> , <a href="#">#USE DELAY</a>  |

## delay\_us( )

|                |   |
|----------------|---|
| Syntax:        | <code>delay_us (time)</code>  |
| Parameters:    | <p><b>time</b> - a variable 0-65535(int16) or a constant 0-65535</p> <p>Note: Previous compiler versions ignored the upper byte of an int16, now the upper byte affects the time.</p>   |
| Returns:       | undefined   |
| Function:      | <p>Creates code to perform a delay of the specified length. Time is specified in microseconds. Shorter delays will be <code>INLINE</code> code and longer delays and variable delays are calls to a function. This function works by executing a precise number of instructions to cause the requested delay. It does not use any timers. If interrupts are enabled the time spent in an interrupt routine is not counted toward the time.</p> <p>The delay time may be longer than requested if an interrupt is serviced during the delay. The time spent in the ISR does not count toward the delay time.</p> |
| Availability:  | All devices   |
| Requires:      | <code>#USE DELAY</code>   |
| Examples:      | <pre>#use delay(clock=20000000)  do {   output_high(PIN_B0);   delay_us(duty);   output_low(PIN_B0);   delay_us(period-duty); } while(TRUE);</pre>  |
| Example Files: | <a href="#">ex_sqw.c</a>  |
| Also See:      | <a href="#">delay_ms()</a> , <a href="#">delay_cycles()</a> , <a href="#">#USE DELAY</a>  |

## disable\_interrupts( )

|                |   |
|----------------|---|
| Syntax:        | <p>disable_interrupts (<i>name</i>)<br/>         disable_interrupts (<i>INTR_XX</i>)<br/>         disable_interrupts (<i>expression</i>)</p>  |
| Parameters:    | <p><b>name</b> - a constant defined in the devices .h file</p> <p>INTR_XX – Allows user selectable interrupt options like INTR_NORMAL, INTR_ALTERNATE, INTR_LEVEL</p> <p>expression – A non-constant expression</p>   |
| Returns:       | When INTR_LEVELx is used as a parameter, this function will return the previous level.  |
| Function:      | <p><b>Name</b> - Disables the interrupt for the given name. Valid specific names are the same as are used in #INT_xxx and are listed in the devices .h file. Note that it is not necessary to disable interrupts inside an interrupt service routine since interrupts are automatically disabled.</p> <p>INTR_GLOBAL – Disables all interrupts that can be disabled</p> <p>INTR_NESTING – Disallows an interrupt from interrupting another</p> <p>INTR_NORMAL – Use normal vectors for the ISR</p> <p>INTR_ALTERNATE – Use alternate vectors for the ISR</p> <p>INTR_LEVEL0 .. INTR_LEVEL7 – Disables interrupts at this level and below, enables interrupts above this level</p> <p>INTR_CN_PIN   PIN_xx – Disables a CN pin interrupts</p> <p>expression – Disables interrupts during evaluation of the expression.</p> |
| Availability:  | All dsPIC and PIC24 devices   |
| Requires:      | Should have a #INT_xxxx, constants are defined in the devices .h file.  |
| Examples:      | <pre> disable_interrupts(INT_RDA); // RS232 OFF disable_interrupts( memcpy(buffer1,buffer2,10 ) ); enable_interrupts(ADC_DONE); enable_interrupts(RB_CHANGE); // these enable the interrupts </pre>   |
| Example Files: | None  |
| Also See:      | <a href="#">enable_interrupts()</a> , <a href="#">#INT_xxxx</a> , <a href="#">Interrupts Overview</a>   |

## div( ) ldiv( )

Syntax:

```
idiv=div(num, denom)
ldiv =ldiv(lnum, ldenom)
```

Parameters:

**num** and **denom** are signed integers.  
**num** is the numerator and **denom** is the denominator.  
**lnum** and **ldenom** are signed longs , signed int32, int48 or int64  
**lnum** is the numerator and **ldenom** is the denominator.

Returns:

idiv is a structure of type div\_t and ldiv is a structure of type ldiv\_t. The div function returns a structure of type div\_t, comprising of both the quotient and the remainder. The ldiv function returns a structure of type ldiv\_t, comprising of both the quotient and the remainder.

Function:

The div and ldiv function computes the quotient and remainder of the division of the numerator by the denominator. If the division is inexact, the resulting quotient is the integer or long of lesser magnitude that is the nearest to the algebraic quotient. If the result cannot be represented, the behavior is undefined; otherwise  $quot * denom + rem$  shall equal  $num$ .

Availability:

All devices.

Requires:

```
#INCLUDE <STDLIB.H>
```

Examples:

```
div_t idiv;
ldiv_t ldiv;
idiv=div(3,2);
//idiv will contain quot=1 and rem=1

ldiv=ldiv(300,250);
//ldiv will contain ldiv.quot=1 and ldiv.rem=50
```

Example

None

Files:

Also See:

None

## dma\_start( )

Syntax:

```
dma_start(channel, mode, addressA, addressB, count);
```

Parameters:

**Channel**- The channel used in the DMA transfer

**mode** - The mode used for the DMA transfer.

**addressA**- The start RAM address of the buffer to use located within the DMA RAM bank.

**addressB**- If using PING\_PONG mode the start RAM address of the second buffer to use located within the DMA RAM bank.

Returns: void

Function: Starts the DMA transfer for the specified channel in the specified mode of operation.

Availability: Devices that have the DMA module.

Requires: Nothing

Examples: 

```
dma_start(2, DMA_CONTINOUS | DMA_PING_PONG, 0x4000,
0x4200,255);
// This will setup the DMA channel 2 for continuous
ping-pong mode with DMA RAM addresses of 0x4000 and
0x4200.
```

Example Files: None

Also See: [setup\\_dma\(\)](#), [dma\\_status\(\)](#)

## dma\_status( )

Syntax: Value = dma\_status(**channel**);

Parameters: **Channel** – The channel whose status is to be queried.

Returns: Returns a 8-bit int. Possible return values are :  
DMA\_IN\_ERROR 0x01  
DMA\_OUT\_ERROR 0x02  
DMA\_B\_SELECT 0x04

Function: This function will return the status of the specified channel in the DMA module.

Availability: Devices that have the DMA module.

Requires: Nothing

## TEST PCD

Examples: 

```
Int8 value;
value = dma_status(3); // This will return the
status of channel 3 of the DMA module.
```

Example Files: None  
Also See: [setup\\_dma\(\)](#), [dma\\_start\(\)](#).

## enable\_interrupts( )

Syntax: `enable_interrupts (name)`  
`enable_interrupts (INTR_XX)`

Parameters: **name**- a constant defined in the devices .h file  
  
INTR\_XX – Allows user selectable interrupt options like INTR\_NORMAL, INTR\_ALTERNATE, INTR\_LEVEL

Returns: undefined

Function: **Name** -Enables the interrupt for the given name. Valid specific names are the same as are used in #INT\_xxx and are listed in the devices .h file.

INTR\_GLOBAL – Enables all interrupt levels (same as INTR\_LEVEL0)

INTR\_NESTING – Enables one interrupt to interrupt another

INTR\_NORMAL – Use normal vectors for the ISR

INTR\_ALTERNATE – Use alternate vectors for the ISR

INTR\_LEVEL0 .. INTR\_LEVEL7 – Enables interrupts at this level and above, interrupts at lower levels are disabled

INTR\_CN\_PIN | PIN\_xx – Enables a CN pin interrupts

Availability: All dsPIC and PIC24 devices

Requires: Should have a #INT\_xxxx, Constants are defined in the devices .h file.

Examples: 

```
enable_interrupts(INT_TIMER0);
enable_interrupts(INT_TIMER1);
enable_interrupts(INTR_CN_PIN|Pin_B0);
```

Example Files: None

Also See: [disable\\_enterrupts\(\)](#), [#INT\\_xxxx](#), [Interrupts Overview](#)



## erase\_program\_memory

Syntax: `erase_program_memory (address);`

Parameters: `address` is 32 bits. The least significant bits may be ignored.

Returns: undefined

Function: Erases `FLASH_ERASE_SIZE` bytes to `0xFFFF` in program memory. `FLASH_ERASE_SIZE` varies depending on the part.

|           |                               |
|-----------|-------------------------------|
| Family    | <code>FLASH_ERASE_SIZE</code> |
| dsPIC30F  | 32 instructions (96 bytes)    |
| dsPIC33FJ | 512 instructions (1536 bytes) |
| PIC24FJ   | 512 instructions (1536 bytes) |
| PIC24HJ   | 512 instructions (1536 bytes) |

NOTE: Each instruction on the PCD is 24 bits wide (3 bytes)  
See `write_program_memory()` for more information on program memory access.

Availability: All devices

Requires: Nothing

Examples: `Int32 address = 0x2000;`

```
erase_program_memory(address); // erase block of
memory from 0x2000 to 0x2400 for a PIC24HJ/FJ /33FJ
device, or erase 0x2000 to 0x2040 for a dsPIC30F
chip
```

Example Files: None

Also See: [write\\_program\\_memory\(\)](#), [Program Eeprom Overview](#)

## exp( )

Syntax: `result = exp (value)`

Parameters: **value** is any float type

Returns: A float with a precision equal to **value**

Function: Computes the exponential function of the argument. This is e to the power of value where e is the base of natural logarithms. `exp(1)` is 2.7182818.

Note on error handling:  
If "errno.h" is included then the domain and range

errors are stored in the `errno` variable. The user can check the `errno` to see if an error has occurred and print the error using the `perror` function.

Range error occur in the following case:

- `exp`: when the argument is too large

Availability: All devices

Requires: `#INCLUDE <math.h>`

Examples: `// Calculate x to the power of y`

```
x_power_y = exp( y * log(x) );
```

Example Files: None

Files:

Also See: [pow\(\)](#), [log\(\)](#), [log10\(\)](#)

## ext\_int\_edge( )

Syntax: `ext_int_edge ( source, edge )`

Parameters: **source** is a constant 0,1 or 2 for the PIC18XXX and 0 otherwise. Source is optional and defaults to 0.  
**edge** is a constant `H_TO_L` or `L_TO_H` representing "high to low" and "low to high"

Returns: undefined

Function: Determines when the external interrupt is acted upon. The edge may be `L_TO_H` or `H_TO_L` to specify the rising or falling edge.

Availability: Only devices with interrupts (PCM and PCH)

Requires: Constants are in the devices .h file

Examples: `ext_int_edge( 2, L_TO_H); // Set up PIC18 EXT2`

```
ext_int_edge( H_TO_L ); // Sets up EXT
```

Example Files: [ex\\_wakup.c](#)

Files:

Also See: [#INT\\_EXT](#), [enable\\_interrupts\(\)](#), [disable\\_interrupts](#), [Interrupts Overview](#)

## fabs( )

Syntax: `result=fabs ( value )`

Parameters: **value** is any float type

Returns: result is a float with precision to **value**

Function: The `fabs` function computes the absolute value of a float

Availability: All devices.

Requires: #INCLUDE <math.h>

Examples: 

```
double result;
result=fabs(-40.0)
// result is 40.0
```

Example Files: None

Also See: [abs\(\)](#), [labs\(\)](#)

## floor( )

Syntax: result = floor (**value**)

Parameters: **value** is any float type

Returns: result is a float with precision equal to **value**

Function: Computes the greatest integer value not greater than the argument. Floor (12.67) is 12.00.

Availability: All devices.

Requires: #INCLUDE <math.h>

Examples: 

```
// Find the fractional part of a value
frac = value - floor(value);
```

Example Files: None

Also See: [ceil\(\)](#)

## fmod( )

Syntax: result= fmod (**val1**, **val2**)

Parameters: **val1** is any float type  
**val2** is any float type

Returns: result is a float with precision equal to input parameters **val1** and **val2**

Function: Returns the floating point remainder of val1/val2. Returns the value val1 - i\*val2 for some integer "i" such that, if val2 is nonzero, the result has the same sign as val1 and magnitude less than the

|                |  |
|----------------|--|
|                | magnitude of val2.                                   |
| Availability:  | All devices.   |
| Requires:      | #INCLUDE <math.h>                                    |
| Examples:      | float result;<br>result=fmod(3,2);<br>// result is 1 |
| Example Files: | None   |
| Also See:      | None   |

## free( )

|                |  |
|----------------|--|
| Syntax:        | free( <i>ptr</i> )   |
| Parameters:    | <i>ptr</i> is a pointer earlier returned by the calloc, malloc or realloc.   |
| Returns:       | No value   |
| Function:      | The free function causes the space pointed to by the ptr to be deallocated, that is made available for further allocation. If ptr is a null pointer, no action occurs. If the ptr does not match a pointer earlier returned by the calloc, malloc or realloc, or if the space has been deallocated by a call to free or realloc function, the behavior is undefined. |
| Availability:  | All devices.   |
| Requires:      | #INCLUDE <stdlib.h>  |
| Examples:      | int * iptr;<br>iptr=malloc(10);<br>free(iptr)<br>// iptr will be deallocated   |
| Example Files: | None   |
| Also See:      | <a href="#">realloc()</a> , <a href="#">malloc()</a> , <a href="#">calloc()</a>  |

## frexp( )

|             |   |
|-------------|---|
| Syntax:     | result=frexp ( <i>value</i> , & <i>exp</i> );   |
| Parameters: | <i>value</i> is any float type<br><i>exp</i> is a signed int.   |
| Returns:    | result is a float with precision equal to <i>value</i>  |
| Function:   | The frexp function breaks a floating point number into a normalized fraction and an integral power of |

|                |  |
|----------------|--|
|                | 2. It stores the integer in the signed int object <code>exp</code> . The result is in the interval $[1/2, 1)$ or zero, such that value is result times 2 raised to power <code>exp</code> . If value is zero then both parts are zero. |
| Availability:  | All devices.   |
| Requires:      | <code>#INCLUDE &lt;math.h&gt;</code>   |
| Examples:      | <pre>float result; signed int exp; result=frexp(.5, &amp;exp); // result is .5 and exp is 0</pre>  |
| Example Files: | None   |
| Also See:      | <a href="#">ldexp()</a> , <a href="#">exp()</a> , <a href="#">log()</a> , <a href="#">log10()</a> , <a href="#">modf()</a>   |

## get\_capture( )

|               |   |
|---------------|---|
| Syntax:       | <code>value = get_capture(x, wait)</code>   |
| Parameters:   | <p><code>x</code> defines which input capture result buffer module to read from</p> <p><code>wait</code> signifies if the compiler should read the oldest result in the buffer or the next result to enter the buffer</p>   |
| Returns:      | A 16-bit timer value.   |
| Function:     | <p>If <code>wait</code> is true, the the current capture values in the result buffer are cleared, an the next result to be sent to the buffer is returned. If <code>wait</code> is false, the default setting, the first value currently in the buffer is returned. However, the buffer will only hold four results while waiting for them to be read, so if read isn't being called for every capture event, when <code>wait</code> is false, the buffer will fill with old capture values and any new results will be lost.</p> |
| Availability: | Only available on devices with Input Capture modules  |
| Requires:     | None  |
| Examples:     | <pre>setup_timer3(TMR_INTERNAL   TMR_DIV_BY_8); setup_capture(2, CAPTURE_FE   CAPTURE_TIMER3); while(TRUE) {</pre>  |

```

        timerValue = get_capture(2, TRUE);
        printf("Capture 2 occurred at: %LU",
timerValue);
    }

```

|                |  |
|----------------|--|
| Example Files: | None   |
| Also See:      | <a href="#">setup_capture()</a> , <a href="#">setup_compare()</a> , <a href="#">Input Capture Overview</a> |

## get\_motor\_pwm\_count( )

Syntax: Data16 = get\_motor\_pwm\_count(pwm);

Parameters: **pwm**- Defines the pwm module used.  
**time**- The event time for the PWM unit.

Returns: 16 bits of data

Function: Returns the PWM event on the motor control unit.

Availability: Devices that have the motor control PWM unit.

Requires: None

Examples: Data16 = get\_motor\_pwm\_event(1);

Example Files: None

Also See: [setup\\_motor\\_pwm\(\)](#), [set\\_motor\\_unit\(\)](#), [set\\_motor\\_pwm\\_event\(\)](#), [set\\_motor\\_pwm\\_duty\(\)](#);

## get\_ticks( )

Syntax: value = get\_ticks();

Parameters: None

Returns: value – a 8, 16, 32 or 64 bit integer. (int8, int16, int32 or int64)

Function: Returns the current tick value of the tick timer. The size returned depends on the size of the tick timer.

Availability: All devices.

Requires: #USE\_TIMER(options)

Examples:

```
#USE TIMER(TIMER=1,TICK=1ms,BITS=16,NOISR)

void main(void) {
    unsigned int16 current_tick;

    current_tick = get_ticks();
}
```

Example Files: None

Also See: [#USE TIMER](#), [set\\_ticks\(\)](#)

## get\_timerA( )

Syntax: value=get\_timerA();

Parameters: none

Returns: The current value of the timer as an int8

Function: Returns the current value of the timer. All timers count up. When a timer reaches the maximum value it will flip over to 0 and continue counting (254, 255, 0, 1, 2, ...).

Availability: This function is only available on devices with Timer A hardware.

Requires: Nothing

Examples:

```
set_timerA(0);
while(timerA < 200);
```

Example Files: none

Also See: [set\\_timerA\( \)](#), [setup\\_timer\\_A\( \)](#), [TimerA Overview](#)

## get\_timerB( )

Syntax: value=get\_timerB();

Parameters: none

Returns: The current value of the timer as an int8

Function: Returns the current value of the timer. All timers count up. When a timer reaches the maximum value it will flip over to 0 and continue counting (254, 255, 0, 1, 2, ...).

|                |  |
|----------------|--|
| Availability:  | This function is only available on devices with Timer B hardware.                                |
| Requires:      | Nothing  |
| Examples:      | <pre>set_timerB(0); while(timerB &lt; 200);</pre>  |
| Example Files: | none   |
| Also See:      | <a href="#">set_timerB()</a> , <a href="#">setup_timer_B()</a> , <a href="#">TimerB Overview</a> |

## get\_timerx( )

|                |   |
|----------------|---|
| Syntax:        | <pre>value=get_timer1() value=get_timer2() value=get_timer3() value=get_timer4() value=get_timer5() value=get_timer6() value=get_timer7() value=get_timer8() value=get_timer9()</pre> |
| Parameters:    | None  |
| Returns:       | The current value of the timer as an int16  |
| Function:      | Retrieves the value of the timer, specified by X (which may be 1-9)   |
| Availability:  | This function is available on all devices that have a valid timerX.   |
| Requires:      | Nothing   |
| Examples:      | <pre>if(get_timer2() % 0xA0 == HALF_WAVE_PERIOD)     output_toggle(PIN_B0);</pre>   |
| Example Files: | <a href="#">ex_stwt.c</a>   |
| Also See:      | <a href="#">Timer Overview</a> , <a href="#">setup_timerX()</a> , <a href="#">get_timerXY()</a> , <a href="#">set_timerX()</a> , <a href="#">set_timerXY()</a>                        |

## get\_timerxy( )

|               |   |
|---------------|---|
| Syntax:       | <pre>value=get_timer23() value=get_timer45() value=get_timer67() value=get_timer89()</pre>                    |
| Parameters:   | Void  |
| Returns:      | The current value of the 32 bit timer as an int32   |
| Function:     | Retrieves the 32 bit value of the timers X and Y, specified by XY(which may be 23, 45, 67 and 89)             |
| Availability: | This function is available on all devices that have a valid 32 bit enabled timers. Timers 2 & 3, 4 & 5, 6 & 7 |



and 8 & 9 may be used. The target device must have one of these timer sets. The target timers must be enabled as 32 bit.

|           |  |
|-----------|--|
| Requires: | Nothing  |
| Examples: | <pre>if(get_timer23() &gt; TRIGGER_TIME)     ExecuteEvent();</pre> |

|                |  |
|----------------|--|
| Example Files: | <a href="#">ex_stwt.c</a>  |
| Also See:      | <a href="#">Timer Overview</a> , <a href="#">setup_timerX()</a> , <a href="#">get_timerXY()</a> , <a href="#">set_timerX()</a> , <a href="#">set_timerXY()</a> |

## get\_tris\_x( )

|         |  |
|---------|--|
| Syntax: | <pre>value = get_tris_A(); value = get_tris_B(); value = get_tris_C(); value = get_tris_D(); value = get_tris_E(); value = get_tris_F(); value = get_tris_G(); value = get_tris_H(); value = get_tris_J(); value = get_tris_K();</pre> |
|---------|--|

|                |  |
|----------------|--|
| Parameters:    | None   |
| Returns:       | int16, the value of TRIS register  |
| Function:      | Returns the value of the TRIS register of port A, B, C, D, E, F, G, H, J, or K.        |
| Availability:  | All devices.   |
| Requires:      | Nothing  |
| Examples:      | <pre>tris_a = GET_TRIS_A();</pre>  |
| Example Files: | None   |
| Also See:      | <a href="#">input()</a> , <a href="#">output_low()</a> , <a href="#">output_high()</a> |

## getc( ) getch( ) getchar( ) fgetc( )

|         |  |
|---------|--|
| Syntax: | <pre>value = getc() value = fgetc(<b>stream</b>) value=getch() value=getchar()</pre> |
|---------|--|

|             |  |
|-------------|--|
| Parameters: | <b>stream</b> is a stream identifier (a constant byte) |
| Returns:    | An 8 bit character                                     |

**Function:** This function waits for a character to come in over the RS232 RCV pin and returns the character. If you do not want to hang forever waiting for an incoming character use `kbhit()` to test for a character available. If a built-in USART is used the hardware can buffer 3 characters otherwise GETC must be active while the character is being received by the PIC®.

If `fgetc()` is used then the specified stream is used where `getc()` defaults to STDIN (the last USE RS232).

**Availability:** All devices

**Requires:** #USE RS232

**Examples:**

```
printf("Continue (Y,N)?");
do {
    answer=getch();
}while(answer!='Y' && answer!='N');
```

```
#use rs232 (baud=9600,xmit=pin_c6,
           rcv=pin_c7,stream=HOSTPC)
#use rs232 (baud=1200,xmit=pin_b1,
           rcv=pin_b0,stream=GPS)
#use rs232 (baud=9600,xmit=pin_b3,
           stream=DEBUG)

...
while(TRUE) {
    c=fgetc(GPS);
    fputc(c,HOSTPC);
    if(c==13)
        fprintf(DEBUG,"Got a CR\r\n");
}
```

**Example Files:** [ex\\_stwt.c](#)

**Also See:** [putc\(\)](#), [kbhit\(\)](#), [printf\(\)](#), [#USE RS232](#), [input.c](#), [RS232 I/O Overview](#)

## getenv( )

**Syntax:** value = `getenv (cstring)`;

**Parameters:** cstring is a constant string with a recognized keyword

**Returns:** A constant number, a constant string or 0

**Function:** This function obtains information about the execution environment. The following are recognized keywords. This function returns a constant 0 if the keyword is not understood.

|                 |  |
|-----------------|--|
| FUSE_SET:ffff   | ffff Returns 1 if fuse ffff is enabled   |
| FUSE_VALID:ffff | ffff Returns 1 if fuse ffff is valid     |
| INT:iiii        | Returns 1 if the interrupt iiii is valid |
| ID              | Returns the device ID (set by #ID)       |
| DEVICE          | Returns the device name string (like     |

|                  |   |
|------------------|---|
|                  | "PIC16C74")   |
| CLOCK            | Returns the MPU FOSC  |
| VERSION          | Returns the compiler version as a float                                       |
| VERSION_STRING   | Returns the compiler version as a string                                      |
| PROGRAM_MEMORY   | Returns the size of memory for code (in words)                                |
| STACK            | Returns the stack size  |
| SCRATCH          | Returns the start of the compiler scratch area                                |
| DATA_EEPROM      | Returns the number of bytes of data EEPROM                                    |
| EEPROM_ADDRESS   | Returns the address of the start of EEPROM. 0 if not supported by the device. |
| READ_PROGRAM     | Returns a 1 if the code memory can be read                                    |
| ADC_CHANNELS     | Returns the number of A/D channels  |
| ADC_RESOLUTION   | Returns the number of bits returned from READ_ADC()                           |
| ICD              | Returns a 1 if this is being compiled for a ICD                               |
| SPI              | Returns a 1 if the device has SPI   |
| USB              | Returns a 1 if the device has USB   |
| CAN              | Returns a 1 if the device has CAN   |
| I2C_SLAVE        | Returns a 1 if the device has I2C slave H/W                                   |
| I2C_MASTER       | Returns a 1 if the device has I2C master H/W                                  |
| PSP              | Returns a 1 if the device has PSP   |
| COMP             | Returns a 1 if the device has a comparator                                    |
| VREF             | Returns a 1 if the device has a voltage reference                             |
| LCD              | Returns a 1 if the device has direct LCD H/W                                  |
| UART             | Returns the number of H/W UARTs   |
| AUART            | Returns 1 if the device has an ADV UART                                       |
| CCPx             | Returns a 1 if the device has CCP number x                                    |
| TIMERx           | Returns a 1 if the device has TIMER number x                                  |
| FLASH_WRITE_SIZE | Smallest number of bytes that can be written to FLASH                         |
| FLASH_ERASE_SIZE | Smallest number of bytes that can be  |

|                      |  |
|----------------------|--|
| E                    | erased in FLASH  |
| BYTES_PER_ADDRESS    | Returns the number of bytes at an address location   |
| BITS_PER_INSTRUCTION | Returns the size of an instruction in bits   |
| RAM                  | Returns the number of RAM bytes available for your device.   |
| SFR:name             | Returns the address of the specified special file register. The output format can be used with the preprocessor command #bit. name must match SFR denomination of your target PIC (example: STATUS, INTCON, TXREG, RCREG, etc)                                   |
| BIT:name             | Returns the bit address of the specified special file register bit. The output format will be in "address:bit", which can be used with the preprocessor command #byte. name must match SFR.bit denomination of your target PIC (example: C, Z, GIE, TMR0IF, etc) |
| SFR_VALID:name       | Returns TRUE if the specified special file register name is valid and exists for your target PIC (example: getenv("SFR_VALID:INTCON"))   |
| BIT_VALID:name       | Returns TRUE if the specified special file register bit is valid and exists for your target PIC (example: getenv("BIT_VALID:TMR0IF"))  |
| PIN:PB               | Returns 1 if PB is a valid I/O PIN (like A2)   |
| UARTx_RX             | Returns UARTxPin (like PINxC7)   |
| UARTx_TX             | Returns UARTxPin (like PINxC6)   |
| SPIx_DI              | Returns SPIxDI Pin   |
| SPIx_DO              | Returns SPIxDO Pin   |
| SPIx_CLK             | Returns SPIxCLK Pin  |
| ICx                  | Returns TRUE if ICx is on this part  |
| OCx                  | Returns TRUE if OCx is on this part  |

Availability: All devices

Requires: Nothing

Examples: 

```
#IF getenv("VERSION") < 3.050
    #ERROR Compiler version too old
#endif
```

```

for (i=0; i<getenv("DATA_EEPROM"); i++)
    write_eeprom(i, 0);

#ifdef FUSE_VALID_BROWNOUT
    #FUSE_BROWNOUT
#endif

#define status_reg=GETENV("SFR:STATUS")

#define carry_flag=GETENV("BIT:C")

```

|                |      |
|----------------|------|
| Example Files: | None |
| Also See:      | None |

## gets( ) fgets( )

Syntax: `gets (string)`  
`value = fgets (string, stream)`

|             |  |
|-------------|--|
| Parameters: | <b><i>string</i></b> is a pointer to an array of characters. <b><i>Stream</i></b> is a stream identifier (a constant byte) |
|-------------|--|

|          |           |
|----------|-----------|
| Returns: | undefined |
|----------|-----------|

|           |  |
|-----------|--|
| Function: | <p>Reads characters (using <code>getc()</code>) into the string until a RETURN (value 13) is encountered. The string is terminated with a 0. Note that <code>INPUT.C</code> has a more versatile <code>get_string</code> function.</p> <p>If <code>fgets()</code> is used then the specified stream is used where <code>gets()</code> defaults to <code>STDIN</code> (the last USE RS232).</p> |
|-----------|--|

|               |             |
|---------------|-------------|
| Availability: | All devices |
|---------------|-------------|

|           |                         |
|-----------|-------------------------|
| Requires: | <code>#USE RS232</code> |
|-----------|-------------------------|

|           |   |
|-----------|---|
| Examples: | <pre> char string[30];  printf("Password: "); gets(string); if(strcmp(string, password))     printf("OK"); </pre> |
|-----------|---|

|                |      |
|----------------|------|
| Example Files: | None |
|----------------|------|

|           |  |
|-----------|--|
| Also See: | <a href="#">getc()</a> , <a href="#">get_string</a> in <a href="#">input.c</a> |
|-----------|--|

## goto\_address( )

Syntax: goto\_address(*location*);

Parameters: location is a ROM address, 16 or 32 bit int.

Returns: Nothing

Function: This function jumps to the address specified by location. Jumps outside of the current function should be done only with great caution. This is not a normally used function except in very special situations.

Availability: All devices

Requires: Nothing

Examples: 

```
#define LOAD_REQUEST PIN_B1
#define LOADER 0x1f00

if(input(LOAD_REQUEST))
    goto_address(LOADER);
```

Example [setimp.h](#)

Files:

Also See: [label\\_address\( \)](#)

## high\_speed\_adc\_done( )

Syntax: value = high\_speed\_adc\_done(*[pair]*);

Parameters: **pair** – Optional parameter that determines which ADC pair's ready flag to check. If not used all ready flags are checked.

Returns: An int16. If pair is used 1 will be return if ADC is done with conversion, 0 will be return if still busy. If pair isn't use it will return a bit map of which conversion are ready to be read. For example a return value of 0x0041 means that ADC pair 6, AN12 and AN13, and ADC pair 0, AN0 and AN1, are ready to be read.

Function: Can be polled to determine if the ADC has valid data to be read.

Availability: Only on devices with a built-in high-speed analog to digital converter.

Requires: None

**Examples:**

```
int16 result[2]
setup_high_speed_adc_pair(1,
    INDIVIDUAL_SOFTWARE_TRIGGER);
setup_high_speed_adc( ADC_CLOCK_DIV_4);

read_high_speed_adc(1, ADC_START_ONLY);
while(!high_speed_adc_done(1));
read_high_speed_adc(1, ADC_READ_ONLY, result);
printf("AN2 value = %LX, AN3 value =
    %LX\n\r", result[0], result[1]);
```

**Example Files:** None

**Also See:** [setup\\_high\\_speed\\_adc\(\)](#), [setup\\_high\\_speed\\_adc\\_pair\(\)](#), [read\\_high\\_speed\\_adc\(\)](#)

## i2c\_isr\_state( )

**Syntax:** state = i2c\_isr\_state();  
state = i2c\_isr\_state(stream);

**Parameters:** None

**Returns:** state is an 8 bit int  
0 - Address match received with R/W bit clear, perform i2c\_read( ) to read the I2C address.  
1-0x7F - Master has written data; i2c\_read() will immediately return the data  
0x80 - Address match received with R/W bit set; perform i2c\_read( ) to read the I2C address, and use i2c\_write( ) to pre-load the transmit buffer for the next transaction (next I2C read performed by master will read this byte).  
0x81-0xFF - Transmission completed and acknowledged; respond with i2c\_write() to pre-load the transmit buffer for the next transaction (the next I2C read performed by master will read this byte).

**Function:** Returns the state of I2C communications in I2C slave mode after an SSP interrupt. The return value increments with each byte received or sent.  
  
If 0x00 or 0x80 is returned, an i2c\_read( ) needs to be performed to read the I2C address that was sent (it will match the address configured by #USE I2C so this value can be ignored)

**Availability:** Devices with i2c hardware

**Requires:** #USE I2C

## TEST PCD

Examples:

```
#INT_SSP
void i2c_isr() {
    state = i2c_isr_state();
    if((state== 0 ) || (state== 0x80))
        i@c_read();
    if(state >= 0x80)
        i2c_write(send_buffer[state - 0x80]);
    else if(state > 0)
        rcv_buffer[state - 1] = i2c_read();
}
```

Example Files: [ex\\_slave.c](#)

Also See: [i2c\\_poll](#), [i2c\\_speed](#), [i2c\\_start](#), [i2c\\_stop](#), [i2c\\_slaveaddr](#), [i2c\\_write](#), [i2c\\_read](#), [#USE I2C](#), [I2C Overview](#)

## i2c\_poll( )

Syntax: `i2c_poll()`  
`i2c_poll(stream)`

Parameters: `stream` (optional)- specify the stream defined in `#USE I2C`

Returns: 1 (TRUE) or 0 (FALSE)

Function: The `I2C_POLL()` function should only be used when the built-in SSP is used. This function returns TRUE if the hardware has a received byte in the buffer. When a TRUE is returned, a call to `I2C_READ()` will immediately return the byte that was received.

Availability: Devices with built in I2C

Requires: `#USE I2C`

Examples:

```
i2c_start(); // Start condition
i2c_write(0xc1); // Device address/Read
count=0;
while(count!=4) {
    while(!i2c_poll()) ;
    buffer[count++]= i2c_read(); //Read Next
}
i2c_stop(); // Stop condition
```

Example Files: [ex\\_slave.c](#)

Also See: [i2c\\_speed](#), [i2c\\_start](#), [i2c\\_stop](#), [i2c\\_slaveaddr](#), [i2c\\_isr\\_state](#), [i2c\\_write](#), [i2c\\_read](#), [#USE I2C](#), [I2C Overview](#)

## i2c\_read( )

Syntax: `data = i2c_read();`  
`data = i2c_read(ack);`  
`data = i2c_read(stream, ack);`



|                |  |
|----------------|--|
| Parameters:    | <b>ack</b> -Optional, defaults to 1.<br>0 indicates do not ack.<br>1 indicates to ack.<br><b>stream</b> - specify the stream defined in #USE I2C   |
| Returns:       | data - 8 bit int   |
| Function:      | Reads a byte over the I2C interface. In master mode this function will generate the clock and in slave mode it will wait for the clock. There is no timeout for the slave, use <code>i2c_poll()</code> to prevent a lockup. Use <code>restart_wdt()</code> in the #USE I2C to strobe the watchdog timer in the slave mode while waiting. |
| Availability:  | All devices.   |
| Requires:      | #USE I2C   |
| Examples:      | <pre>i2c_start(); i2c_write(0xa1); data1 = i2c_read(); data2 = i2c_read(); i2c_stop();</pre>   |
| Example Files: | <a href="#">ex_extee.c</a> with <a href="#">2416.c</a>   |
| Also See:      | <a href="#">i2c_poll</a> , <a href="#">i2c_speed</a> , <a href="#">i2c_start</a> , <a href="#">i2c_stop</a> , <a href="#">i2c_slaveaddr</a> , <a href="#">i2c_isr_state</a> , <a href="#">i2c_write</a> , <a href="#">#USE I2C</a> , <a href="#">I2C Overview</a>  |

## **i2c\_slaveaddr( )**

|                |  |
|----------------|--|
| Syntax:        | <code>I2C_SlaveAddr(addr);</code><br><code>I2C_SlaveAddr(stream, addr);</code>   |
| Parameters:    | <code>addr</code> = 8 bit device address<br><code>stream</code> (optional) - specifies the stream used in #USE I2C   |
| Returns:       | nothing  |
| Function:      | This functions sets the address for the I2C interface in slave mode.   |
| Availability:  | Devices with built in I2C  |
| Requires:      | #USE I2C   |
| Examples:      | <pre>i2c_SlaveAddr(0x08); i2c_SlaveAddr(i2cStream1, 0x08);</pre>   |
| Example Files: | <a href="#">ex_slave.c</a>   |
| Also See:      | <a href="#">i2c_poll</a> , <a href="#">i2c_speed</a> , <a href="#">i2c_start</a> , <a href="#">i2c_stop</a> , <a href="#">i2c_isr_state</a> , <a href="#">i2c_write</a> , <a href="#">i2c_read</a> , <a href="#">#USE I2C</a> , <a href="#">I2C Overview</a> |

## i2c\_speed( )

|                |  |
|----------------|--|
| Syntax:        | i2c_speed ( <i>baud</i> )<br>i2c_speed (stream, <i>baud</i> )  |
| Parameters:    | <b>baud</b> is the number of bits per second.<br><b>stream</b> - specify the stream defined in #USE I2C  |
| Returns:       | Nothing.   |
| Function:      | This function changes the I2c bit rate at run time. This only works if the hardware I2C module is being used.  |
| Availability:  | All devices.   |
| Requires:      | #USE I2C   |
| Examples:      | I2C_Speed (400000);  |
| Example Files: | none   |
| Also See:      | <a href="#">i2c_poll</a> , <a href="#">i2c_start</a> , <a href="#">i2c_stop</a> , <a href="#">i2c_slaveaddr</a> , <a href="#">i2c_isr_state</a> , <a href="#">i2c_write</a> , <a href="#">i2c_read</a> , <a href="#">#USE I2C</a> , <a href="#">I2C Overview</a> |

## i2c\_start( )

|               |   |
|---------------|---|
| Syntax:       | i2c_start()<br>i2c_start(stream)<br>i2c_start(stream, restart)  |
| Parameters:   | stream: specify the stream defined in #USE I2C<br>restart: 2 – new restart is forced instead of start<br>1 – normal start is performed<br>0 (or not specified) – restart is done only if the compiler last encountered a I2C_START and no I2C_STOP  |
| Returns:      | undefined   |
| Function:     | Issues a start condition when in the I2C master mode. After the start condition the clock is held low until I2C_WRITE() is called. If another I2C_start is called in the same function before an i2c_stop is called, then a special restart condition is issued. Note that specific I2C protocol depends on the slave device. The I2C_START function will now accept an optional parameter. If 1 the compiler assumes the bus is in the stopped state. If 2 the compiler treats this I2C_START as a restart. If no parameter is passed a 2 is used only if the compiler compiled a I2C_START last with no I2C_STOP since. |
| Availability: | All devices.  |
| Requires:     | #USE I2C  |
| Examples:     | <pre> i2c_start(); i2c_write(0xa0);    // Device address i2c_write(address); // Data to device i2c_start();        // Restart i2c_write(0xa1);    // to change data direction data=i2c_read(0);   // Now read from slave </pre>   |

```
i2c_stop();
```

Example Files: [ex\\_extee.c](#) with [2416.c](#)

Also See: [i2c\\_poll](#), [i2c\\_speed](#), [i2c\\_stop](#), [i2c\\_slaveaddr](#), [i2c\\_isr\\_state](#), [i2c\\_write](#), [i2c\\_read](#), [#USE I2C](#), [I2C Overview](#)

## i2c\_stop( )

Syntax: `i2c_stop()`  
`i2c_stop(stream)`

Parameters: `stream`: (optional) specify stream defined in #USE I2C

Returns: undefined

Function: Issues a stop condition when in the I2C master mode.

Availability: All devices.

Requires: #USE I2C

Examples:

```
i2c_start(); // Start condition
i2c_write(0xa0); // Device address
i2c_write(5); // Device command
i2c_write(12); // Device data
i2c_stop(); // Stop condition
```

Example Files: [ex\\_extee.c](#) with [2416.c](#)

Also See: [i2c\\_poll](#), [i2c\\_speed](#), [i2c\\_start](#), [i2c\\_slaveaddr](#), [i2c\\_isr\\_state](#), [i2c\\_write](#), [i2c\\_read](#), [#USE I2C](#), [I2C Overview](#)

## i2c\_write( )

Syntax: `i2c_write(data)`  
`i2c_write(stream, data)`

Parameters: **data** is an 8 bit int  
**stream** - specify the stream defined in #USE I2C

Returns: This function returns the ACK Bit.  
0 means ACK, 1 means NO ACK, 2 means there was a collision if in Multi\_Master Mode.  
This does not return an ACK if using i2c in slave mode.

Function: Sends a single byte over the I2C interface. In master mode this function will generate a clock with the data and in slave mode it will wait for the clock from the master. No automatic timeout is provided in this function. This function returns the ACK bit. The LSB of the first write after a start determines the direction of data transfer (0 is master to slave). Note that specific I2C protocol depends on the slave device.

Availability: All devices.

|                |  |
|----------------|--|
| Requires:      | <code>#USE I2C</code>  |
| Examples:      | <pre>long cmd; ... i2c_start(); // Start condition i2c_write(0xa0); // Device address i2c_write(cmd); // Low byte of command i2c_write(cmd&gt;&gt;8); // High byte of command i2c_stop(); // Stop condition</pre>  |
| Example Files: | <a href="#">ex_extee.c</a> with <a href="#">2416.c</a>   |
| Also See:      | <a href="#">i2c_poll</a> , <a href="#">i2c_speed</a> , <a href="#">i2c_start</a> , <a href="#">i2c_stop</a> , <a href="#">i2c_slaveaddr</a> , <a href="#">i2c_isr_state</a> , <a href="#">i2c_read</a> , <a href="#">#USE I2C</a> , <a href="#">I2C Overview</a> |

## input( )

|               |   |
|---------------|---|
| Syntax:       | <code>value = input (<i>pin</i>)</code>   |
| Parameters:   | <p><b><i>Pin</i></b> to read. Pins are defined in the devices .h file. The actual value is a bit address. For example, port a (byte 0x2C2 ) bit 3 would have a value of 0x2C2*8+3 or 5651 . This is defined as follows: <code>#define PIN_A3 5651 .</code></p> <p>The PIN could also be a variable. The variable must have a value equal to one of the constants (like PIN_A1) to work properly. The tristate register is updated unless the FAST_I0 mode is set on port A. note that doing I/O with a variable instead of a constant will take much longer time.</p> |
| Returns:      | 0 (or FALSE) if the pin is low,<br>1 (or TRUE) if the pin is high   |
| Function:     | This function returns the state of the indicated pin. The method of I/O is dependent on the last USE *_IO directive. By default with standard I/O before the input is done the data direction is set to input.  |
| Availability: | All devices.  |
| Requires:     | Pin constants are defined in the devices .h file  |
| Examples:     | <pre>while ( !input(PIN_B1) ); // waits for B1 to go high  if( input(PIN_A0) )     printf("A0 is now high\r\n");  int16 i=PIN_B1; while(!i); //waits for B1 to go high</pre>  |

Example Files: [ex\\_pulse.c](#)  
 Also See: [input\\_x\(\)](#), [output\\_low\(\)](#), [output\\_high\(\)](#), [#USE FIXED\\_IO](#), [#USE FAST\\_IO](#), [#USE STANDARD\\_IO](#), [General Purpose I/O](#)

## input\_change\_x( )

Syntax: `value = input_change_a( );`  
`value = input_change_b( );`  
`value = input_change_c( );`  
`value = input_change_d( );`  
`value = input_change_e( );`  
`value = input_change_f( );`  
`value = input_change_g( );`  
`value = input_change_h( );`  
`value = input_change_j( );`  
`value = input_change_k( );`

|                |   |
|----------------|---|
| Parameters:    | None  |
| Returns:       | An 8-bit or 16-bit int representing the changes on the port.  |
| Function:      | This function reads the level of the pins on the port and compares them to the results the last time the <code>input_change_x( )</code> function was called. A 1 is returned if the value has changed, 0 if the value is unchanged. |
| Availability:  | All devices.  |
| Requires:      | None  |
| Examples:      | <code>pin_check = input_change_b( );</code>   |
| Example Files: | None  |
| Also See:      | <a href="#">input()</a> , <a href="#">input_x()</a> , <a href="#">output_x()</a> , <a href="#">#USE FIXED_IO</a> , <a href="#">#USE FAST_IO</a> , <a href="#">#USE STANDARD_IO</a> , <a href="#">General Purpose I/O</a>            |

## input\_state( )

Syntax: `value = input_state(pin)`

|             |   |
|-------------|---|
| Parameters: | <b><i>pin</i></b> to read. Pins are defined in the devices .h file. The actual value is a bit address. For example, port a (byte 0x2C2 ) bit 3 would have a value of $0x2C2 * 8 + 3$ or 5651 . This is defined as follows: <code>#define PIN_A3 5651</code> . |
|-------------|---|

|               |  |
|---------------|--|
| Returns:      | Bit specifying whether pin is high or low. A 1 indicates the pin is high and a 0 indicates it is low.          |
| Function:     | This function reads the level of a pin without changing the direction of the pin as <code>INPUT()</code> does. |
| Availability: | All devices.   |
| Requires:     | Nothing  |

## TEST PCD

Examples: 

```
level = input_state(pin_A3);  
printf("level: %d", level);
```

Example Files: None

Also See: [input\(\)](#), [set\\_tris\\_x\(\)](#), [output\\_low\(\)](#), [output\\_high\(\)](#), [General Purpose I/O](#)

## input\_x( )

Syntax: 

```
value = input_a()  
value = input_b()  
value = input_c()  
value = input_d()  
value = input_e()  
value = input_f()  
value = input_g()  
value = input_h()  
value = input_j()  
value = input_k()
```

Parameters: None

Returns: An 16 bit int representing the port input data.

Function: Inputs an entire word from a port. The direction register is changed in accordance with the last specified `#USE *_IO` directive. By default with standard I/O before the input is done the data direction is set to input.

Availability: All devices.

Requires: Nothing

Examples: 

```
data = input_b();
```

Example Files: [ex\\_psp.c](#)

Also See: [input\(\)](#), [output\\_x\(\)](#), [#USE FIXED\\_IO](#), [#USE FAST\\_IO](#), [#USE STANDARD\\_IO](#)

## interrupt\_active( )

Syntax: 

```
interrupt_active (interrupt)
```

Parameters: Interrupt – constant specifying the interrupt

Returns: Boolean value

Function: The function checks the interrupt flag of the specified interrupt and returns true in case the flag is set.

Availability: Device with interrupts (PCM and PCH)

Requires: Should have a #INT\_xxxx, Constants are defined in the devices .h file.

Examples: `interrupt_active(INT_TIMER0);`  
`interrupt_active(INT_TIMER1);`

Example Files: None

Also See: [disable\\_interrupts\(\)](#), [#INT](#), [Interrupts Overview](#)

**isalnum(char)**  
**isalpha(char) isdigit(char)**  
**islower(char)**  
**isspace(char)**  
**isupper(char)**  
**isxdigit(char) iscntrl(x)**  
**isgraph(x) isprint(x)**  
**ispunct(x)**

Syntax: `value = isalnum(datac)`  
`value = isalpha(datac)`  
`value = isdigit(datac)`  
`value = islower(datac)`  
`value = isspace(datac)`  
`value = isupper(datac)`  
`value = isxdigit(datac)`  
`value = iscntrl(datac)`  
`value = isgraph(datac)`  
`value = isprint(datac)`  
`value = ispunct(datac)`

Parameters: **datac** is a 8 bit character

Returns: 0 (or FALSE) if datac dose not match the criteria, 1 (or TRUE) if datac does match the criteria.

Function: Tests a character to see if it meets specific criteria as follows:

|                         |                                  |
|-------------------------|----------------------------------|
| <code>isalnum(x)</code> | X is 0..9, 'A'..'Z', or 'a'..'z' |
| <code>isalpha(x)</code> | X is 'A'..'Z' or 'a'..'z'        |
| <code>isdigit(x)</code> | X is '0'..'9'                    |
| <code>islower(x)</code> | X is 'a'..'z'                    |
| <code>isupper(x)</code> | X is 'A'..'Z'                    |
| <code>isspace(x)</code> | X is a space                     |

|                |  |  |
|----------------|--|--|
|                | isxdigit(x)  | X is '0'..'9', 'A'..'F', or 'a'..'f'                 |
|                | iscntrl(x)   | X is less than a space                               |
|                | isgraph(x)   | X is greater than a space                            |
|                | isprint(x)   | X is greater than or equal to a space                |
|                | ispunct(x)   | X is greater than a space and not a letter or number |
| Availability:  | All devices.   |  |
| Requires:      | #INCLUDE <ctype.h>   |  |
| Examples:      | <pre>char id[20]; ... if (isalpha(id[0])) {     valid_id=TRUE;     for (i=1; i&lt;strlen(id); i++)         valid_id=valid_id &amp;&amp; isalnum(id[i]); } else     valid_id=FALSE;</pre> |  |
| Example Files: | <a href="#">ex_str.c</a>   |  |
| Also See:      | <a href="#">isamong()</a>  |  |

## isamong( )

|                |  |
|----------------|--|
| Syntax:        | result = isamong ( <b>value</b> , <b>cstring</b> )   |
| Parameters:    | <b>value</b> is a character<br><b>cstring</b> is a constant sting  |
| Returns:       | 0 (or FALSE) if value is not in cstring<br>1 (or TRUE) if value is in cstring  |
| Function:      | Returns TRUE if a character is one of the characters in a constant string.   |
| Availability:  | All devices  |
| Requires:      | Nothing  |
| Examples:      | <pre>char x= 'x'; ... if ( isamong ( x,     "0123456789ABCDEFGHIJKLMNOPQRSTUVWXYZ" )     printf ("The character is valid");</pre>  |
| Example Files: | #INCLUDE <ctype.h>   |
| Also See:      | <a href="#">isalnum()</a> , <a href="#">isalpha()</a> , <a href="#">isdigit()</a> , <a href="#">isspace()</a> , <a href="#">islower()</a> , <a href="#">isupper()</a> , <a href="#">isxdigit()</a> |



## itoa( )

Syntax:            **string** = itoa(**i32value**, **i8base**, **string**)  
                      **string** = itoa(**i48value**, **i8base**, **string**)  
                      **string** = itoa(**i64value**, **i8base**, **string**)

Parameters:        **i32value** is a 32 bit int  
                      **i48value** is a 48 bit int  
                      **i64value** is a 64 bit int  
                      **i8base** is a 8 bit int  
                      **string** is a pointer to a null terminated string of characters

Returns:            **string** is a pointer to a null terminated string of characters

Function:           Converts the signed int32 , int48, or a int64 to a string according to the provided base and returns the converted value if any. If the result cannot be represented, the function will return 0.

Availability:       All devices

Requires:           #INCLUDE <stdlib.h>

Examples:           

```
int32 x=1234;
char string[5];

itoa(x,10, string);
// string is now "1234"
```

Example Files:     None

Also See:           None

## kbhit( )

Syntax:            value = kbhit()  
                      value = kbhit (**stream**)

Parameters:        **stream** is the stream id assigned to an available RS232 port. If the stream parameter is not included, the function uses the primary stream used by getc().

Returns:            0 (or FALSE) if getc() will need to wait for a character to come in, 1 (or TRUE) if a character is ready for getc()

Function:           If the RS232 is under software control this function returns TRUE if the start bit of a character is being sent on the RS232 RCV pin. If the RS232 is hardware this function returns TRUE if a character has been received and is waiting in the hardware buffer for getc() to read. This function may be used to poll for data without stopping and waiting for the data to appear. Note that in the case of software RS232 this function should be called at least 10 times the bit rate to ensure incoming data is not lost.

Availability:       All devices.

Requires: [#USE RS232](#)

```
Examples: char timed_getc() {
           long timeout;
           timeout_error=FALSE;
           timeout=0;
           while(!kbhit() && (++timeout<50000)) // 1/2
                                                    // second
               delay_us(10);
           if(kbhit())
               return(getc());
           else {
               timeout_error=TRUE;
               return(0);
           }
       }
```

Example Files: [ex\\_tgetc.c](#)

Also See: [getc\(\)](#), [#USE RS232](#), [RS232 I/O Overview](#)

## label\_address( )

Syntax: value = label\_address(**label**);

Parameters: **label** is a C label anywhere in the function

Returns: A 16 bit int in PCB,PCM and a 32 bit int for PCH

Function: This function obtains the address in ROM of the next instruction after the label. This is not a normally used function except in very special situations.

Availability: All devices.

Requires: Nothing

```
Examples: start:
           a = (b+c)<<2;
           end:
           printf("It takes %lu ROM locations.\r\n",
               label_address(end)-label_address(start));
```

Example Files: [setjmp.h](#)

Also See: [goto\\_address\(\)](#)

## labs( )

Syntax: `result = labs ( value )`

Parameters: ***value*** is a 16 , 32, 48 or 64 bit signed long int

Returns: A signed long int of type ***value***

Function: Computes the absolute value of a long integer.

Availability: All devices.

Requires: `#INCLUDE <stdlib.h>`

Examples: 

```
if(labs( target_value - actual_value ) > 500)
    printf("Error is over 500 points\r\n");
```

Example Files: None

Also See: [abs\(\)](#)

## ldexp( )

Syntax: `result= ldexp ( value, exp );`

Parameters: ***value*** is float any float type  
***exp*** is a signed int.

Returns: result is a float with value result times 2 raised to power exp.  
result will have a precision equal to ***value***

Function: The ldexp function multiplies a floating-point number by an integral power of 2.

Availability: All devices.

Requires: `#INCLUDE <math.h>`

Examples: 

```
float result;
result=ldexp(.5,0);
// result is .5
```

Example Files: None

Also See: [frexp\(\)](#), [exp\(\)](#), [log\(\)](#), [log10\(\)](#), [modf\(\)](#)

## log( )

Syntax:            result = log ( *value* )

Parameters:       *value* is any float type

Returns:           A float with precision equal to *value*

Function:          Computes the natural logarithm of the float x. If the argument is less than or equal to zero or too large, the behavior is undefined.

Note on error handling:

"errno.h" is included then the domain and range errors are stored in the errno variable. The user can check the errno to see if an error has occurred and print the error using the perror function.

Domain error occurs in the following cases:

- log: when the argument is negative

Availability:      All devices

Requires:          #include <math.h>

Examples:          lnx = log(x);

Example            None

Files:

Also See:          [log10\(\)](#), [exp\(\)](#), [pow\(\)](#)

## log10( )

Syntax:            result = log10 ( *value* )

Parameters:       *value* is any float type

Returns:           A float with precision equal to *value*

Function:          Computes the base-ten logarithm of the float x. If the argument is less than or equal to zero or too large, the behavior is undefined.

Note on error handling:

If "errno.h" is included then the domain and range errors are stored in the errno variable. The user can check the errno to see if an error has occurred and print the error using the perror function.

Domain error occurs in the following cases:

- log10: when the argument is negative

Availability: All devices

Requires: #INCLUDE <math.h>

Examples: `db = log10( read_adc() * (5.0/255) ) * 10;`

Example None

Files:

Also See: [log\(\)](#), [exp\(\)](#), [pow\(\)](#)

## longjmp( )

Syntax: longjmp (*env*, *val*)

Parameters: **env**: The data object that will be restored by this function  
**val**: The value that the function setjmp will return. If val is 0 then the function setjmp will return 1 instead.

Returns: After longjmp is completed, program execution continues as if the corresponding invocation of the setjmp function had just returned the value specified by val.

Function: Performs the non-local transfer of control.

Availability: All devices

Requires: #INCLUDE <setjmp.h>

Examples: `longjmp(jmpbuf, 1);`

Example None

Files:

Also See: [setjmp\(\)](#)

## make8( )

Syntax: `i8 = MAKE8(var, offset)`

Parameters: **var** is a 16 or 32 bit integer.  
**offset** is a byte offset of 0,1,2 or 3.

Returns: An 8 bit integer

**Function:** Extracts the byte at offset from var. Same as: `i8 = (((var >> (offset*8)) & 0xff) & 0xff)` except it is done with a single byte move.

**Availability:** All devices

**Requires:** Nothing

**Examples:**

```
int32 x;
int y;

y = make8(x,3); // Gets MSB of x
```

**Example Files:** None

**Also See:** [make16\(\)](#), [make32\(\)](#)

## make16( )

**Syntax:** `i16 = MAKE16(varhigh, varlow)`

**Parameters:** *varhigh* and *varlow* are 8 bit integers.

**Returns:** A 16 bit integer

**Function:** Makes a 16 bit number out of two 8 bit numbers. If either parameter is 16 or 32 bits only the lsb is used. Same as: `i16 = (int16)(varhigh&0xff)*0x100+(varlow&0xff)` except it is done with two byte moves.

**Availability:** All devices

**Requires:** Nothing

**Examples:**

```
long x;
int hi,lo;

x = make16(hi,lo);
```

**Example Files:** [ltc1298.c](#)

**Also See:** [make8\(\)](#), [make32\(\)](#)

## make32( )

Syntax: `i32 = MAKE32(var1, var2, var3, var4)`

Parameters: **var1-4** are a 8 or 16 bit integers. **var2-4** are optional.

Returns: A 32 bit integer

Function: Makes a 32 bit number out of any combination of 8 and 16 bit numbers. Note that the number of parameters may be 1 to 4. The msb is first. If the total bits provided is less than 32 then zeros are added at the msb.

Availability: All devices

Requires: Nothing

Examples:

```
int32 x;
int y;
long z;

x = make32(1,2,3,4); // x is 0x01020304

y=0x12;
z=0x4321;

x = make32(y,z); // x is 0x00124321

x = make32(y,y,z); // x is 0x12124321
```

Example Files: [ex\\_freqc.c](#)

Also See: [make8\(\)](#), [make16\(\)](#)

## malloc( )

Syntax: `ptr=malloc(size)`

Parameters: **size** is an integer representing the number of bytes to be allocated.

Returns: A pointer to the allocated memory, if any. Returns null otherwise.

Function: The malloc function allocates space for an object whose size is specified by size and whose value is indeterminate.

Availability: All devices

Requires: #INCLUDE <stdlib.h>

Examples: 

```
int * iptr;
iptr=malloc(10);
// iptr will point to a block of memory of 10 bytes.
```

Example Files: None

Also See: [realloc\(\)](#), [free\(\)](#), [calloc\(\)](#)

## memcpy( ) memmove( )

Syntax: `memcpy( destination, source, n )`  
`memmove(destination, source, n)`

Parameters: ***destination*** is a pointer to the destination memory, ***source*** is a pointer to the source memory, ***n*** is the number of bytes to transfer

Returns: undefined

Function: Copies *n* bytes from source to destination in RAM. Be aware that array names are pointers where other variable names and structure names are not (and therefore need a & before them).

Memmove performs a safe copy (overlapping objects doesn't cause a problem). Copying takes place as if the *n* characters from the source are first copied into a temporary array of *n* characters that doesn't overlap the destination and source objects. Then the *n* characters from the temporary array are copied to destination.

Availability: All devices

Requires: Nothing

Examples: 

```
memcpy(&structA, &structB, sizeof (structA));
memcpy(arrayA, arrayB, sizeof (arrayA));
memcpy(&structA, &databyte, 1);
```

```
char a[20]="hello";
memmove(a, a+2, 5);
// a is now "llo"MEMMOVE()
```

Example Files: None

Also See: [strcpy\(\)](#), [memset\(\)](#)



## memset( )

Syntax:            memset (*destination*, *value*, *n*)

Parameters:        *destination* is a pointer to memory, *value* is a 8 bit int, *n* is a 16 bit int.

Returns:            undefined

Function:           Sets *n* number of bytes, starting at *destination*, to *value*. Be aware that array names are pointers where other variable names and structure names are not (and therefore need a & before them).

Availability:       All devices

Requires:           Nothing

Examples:           

```
memset(arrayA, 0, sizeof(arrayA));
memset(arrayB, '?', sizeof(arrayB));
memset(&structA, 0xFF, sizeof(structA));
```

Example             None

Files:

Also See:           [memcpy\(\)](#)

## modf( )

Syntax:            result= modf (*value*, & *integral*)

Parameters:        *value* is any float type  
*integral* is any float type

Returns:            result is a float with precision equal to **value**

Function:           The modf function breaks the argument value into integral and fractional parts, each of which has the same sign as the argument. It stores the integral part as a float in the object *integral*.

Availability:       All devices

Requires:           #include <math.h>

Examples:           

```
float 48 result, integral;
result=modf(123.987,&integral);
// result is .987 and integral is 123.0000
```

Example             None

Files:

Also See:           None

## **\_mul()**

Syntax: `prod=_mul(val1, val2);`

Parameters: **val1** and **val2** are both 8-bit, 16-bit, or 48-bit integers

Returns:

| <i>val1</i> | <i>val2</i> | <i>prod</i> |
|-------------|-------------|-------------|
| 8           | 8           | 16          |
| 16*         | 16          | 32          |
| 32*         | 32          | 64          |
| 48*         | 48          | 64**        |

\* or less

\*\* large numbers will overflow with wrong results

Function: Performs an optimized multiplication. By accepting a different type than it returns, this function avoids the overhead of converting the parameters to a larger type.

Availability: All devices

Requires: Nothing

Examples: 

```
int a=50, b=100;
long int c;
c = _mul(a, b);    //c holds 5000
```

Example Files: None

Also See: None

## **nargs()**

Syntax: `Void foo(char * str, int count, ...)`

Parameters: The function can take variable parameters. The user can use `stdarg` library to create functions that take variable parameters.

Returns: Function dependent.

Function: The `stdarg` library allows the user to create functions that supports variable arguments.

The function that will accept a variable number of arguments must have at least one actual, known parameters, and it may have more. The number of arguments is often passed to the function in one of its actual parameters. If the variable-length argument list can involve more than one type, the type information is generally passed as well. Before processing can begin, the function creates a special argument pointer of type `va_list`.

Availability: All devices

Requires: `#INCLUDE <stdarg.h>`

Examples:

```
int foo(int num, ...)
{
    int sum = 0;
    int i;
    va_list argptr; // create special argument pointer
    va_start(argptr,num); // initialize argptr
    for(i=0; i<num; i++)
        sum = sum + va_arg(argptr, int);
    va_end(argptr); // end variable processing
    return sum;
}

void main()
{
    int total;
    total = foo(2,4,6,9,10,2);
}
```

Example: None

Files:

Also See: [va\\_start\(\)](#), [va\\_end\(\)](#), [va\\_arg\(\)](#)

## offsetof( ) offsetofbit( )

Syntax: `value = offsetof(stype, field);`  
`value = offsetofbit(stype, field);`

Parameters: ***stype*** is a structure type name.  
***Field*** is a field from the above structure

Returns: An 8 bit byte

Function: These functions return an offset into a structure for the indicated field. `offsetof` returns the offset in bytes and `offsetofbit` returns the offset in bits.

Availability: All devices

Requires: #INCLUDE <stddef.h>

Examples:

```

struct time_structure {
    int hour, min, sec;
    int zone : 4;
    int1 daylight_savings;
}

x = offsetof(time_structure, sec);
    // x will be 2
x = offsetofbit(time_structure, sec);
    // x will be 16
x = offsetof (time_structure,
    daylight_savings);
    // x will be 3
x = offsetofbit(time_structure,
    daylight_savings);
    // x will be 28

```

Example Files: None

Also See: None

## output\_x()

Syntax:

```

output_a (value)
output_b (value)
output_c (value)
output_d (value)
output_e (value)
output_f (value)
output_g (value)
output_h (value)
output_j (value)
output_k (value)

```

Parameters: **value** is a 16 bit int

Returns: Undefined

Function: Output an entire word to a port. The direction register is changed in accordance with the last specified #USE \*\_IO directive.

Availability: All devices, however not all devices have all ports (A-E)

Requires: Nothing

Examples: OUTPUT\_B(0xf0);

Example Files: [ex\\_patg.c](#)

Also See: [input\(\)](#), [output\\_low\(\)](#), [output\\_high\(\)](#), [output\\_float\(\)](#), [output\\_bit\(\)](#), [#USE FIXED\\_IO](#), [#USE FAST\\_IO](#), [#USE STANDARD\\_IO](#), [General Purpose I/O](#)

## output\_bit( )

Syntax:        `output_bit (pin, value)`

Parameters:    **Pins** are defined in the devices .h file. The actual number is a bit address. For example, port a (byte 0x2C2 ) bit 3 would have a value of 0x2C2\*8+3 or 5651 . This is defined as follows: #define PIN\_A3 5651 . The PIN could also be a variable. The variable must have a value equal to one of the constants (like PIN\_A1) to work properly. The tristate register is updated unless the FAST\_IO mode is set on port A. Note that doing I/O with a variable instead of a constant will take much longer time. **Value** is a 1 or a 0.

Returns:        undefined

Function:       Outputs the specified value (0 or 1) to the specified I/O pin. The method of setting the direction register is determined by the last #USE \*\_IO directive.

Availability:   All devices.

Requires:       Pin constants are defined in the devices .h file

```
Examples:        output_bit( PIN_B0, 0);
                 // Same as output_low(pin_B0);

                 output_bit( PIN_B0, input( PIN_B1 ) );
                 // Make pin B0 the same as B1

                 output_bit( PIN_B0,
                             shift_left(&data,1,input(PIN_B1)));
                 // Output the MSB of data to
                 // B0 and at the same time
                 // shift B1 into the LSB of data

                 int16 i=PIN_B0;
                 ouput_bit(i,shift_left(&data,1,input(PIN_B1)));
                 //same as above example, but
                 //uses a variable instead of a constant
```

Example Files:   [ex\\_extee.c](#) with [9356.c](#)

Also See:        [input\(\)](#), [output\\_low\(\)](#), [output\\_high\(\)](#), [output\\_float\(\)](#), [output\\_x\(\)](#), [#USE FIXED\\_IO](#), [#USE FAST\\_IO](#), [#USE STANDARD\\_IO](#), [General Purpose I/O](#)

## output\_drive( )

Syntax: `output_drive(pin)`

Parameters: **Pins** are defined in the devices .h file. The actual value is a bit address. For example, port a (byte 0x2C2 ) bit 3 would have a value of 0x2C2\*8+3 or 5651 . This is defined as follows: #DEFINE PIN\_A3 5651 .

Returns: undefined

Function: Sets the specified pin to the output mode.

Availability: All devices.

Requires: Pin constants are defined in the devices.h file.

Examples: 

```
output_drive(pin_A0); // sets pin_A0 to output its value
output_bit(pin_B0, input(pin_A0)) // makes B0 the same as A0
```

Example Files: None

Also See: [input\(\)](#), [output\\_low\(\)](#), [output\\_high\(\)](#), [output\\_bit\(\)](#), [output\\_x\(\)](#), [output\\_float\(\)](#)

## output\_float( )

Syntax: `output_float (pin)`

Parameters: **Pins** are defined in the devices .h file. The actual value is a bit address. For example, port a (byte 0x2C2 ) bit 3 would have a value of 0x2C2\*8+3 or 5651 . This is defined as follows: #DEFINE PIN\_A3 5651 . The PIN could also be a variable to identify the pin. The variable must have a value equal to one of the constants (like PIN\_A1) to work properly. Note that doing I/O with a variable instead of a constant will take much longer time.

Returns: undefined

Function: Sets the specified pin to the input mode. This will allow the pin to float high to represent a high on an open collector type of connection.

Availability: All devices.

Requires: Pin constants are defined in the devices .h file

Examples: 

```
if( (data & 0x80)==0 )
    output_low(pin_A0);
else
    output_float(pin_A0);
```

Example Files: None

Also See: [input\(\)](#), [output\\_low\(\)](#), [output\\_high\(\)](#), [output\\_bit\(\)](#), [output\\_x\(\)](#), [output\\_drive\(\)](#), [#USE FIXED\\_IO](#), [#USE FAST\\_IO](#), [#USE STANDARD\\_IO](#), [General Purpose I/O](#)

## output\_high( )

|                |   |
|----------------|---|
| Syntax:        | output_high ( <i>pin</i> )  |
| Parameters:    | <b>Pin</b> to write to. Pins are defined in the devices .h file. The actual value is a bit address. For example, port a (byte 0x2C2 ) bit 3 would have a value of 0x2C2*8+3 or 5651 . This is defined as follows: #DEFINE PIN_A3 5651 . The PIN could also be a variable. The variable must have a value equal to one of the constants (like PIN_A1) to work properly. The tristate register is updated unless the FAST_IO mode is set on port A. Note that doing I/O with a variable instead of a constant will take much longer time. |
| Returns:       | undefined   |
| Function:      | Sets a given pin to the high state. The method of I/O used is dependent on the last USE *_IO directive.   |
| Availability:  | All devices.  |
| Requires:      | Pin constants are defined in the devices .h file  |
| Examples:      | output_high(PIN_A0);<br>output_low(PIN_A1);   |
| Example Files: | <a href="#">ex_sqw.c</a>  |
| Also See:      | <a href="#">input()</a> , <a href="#">output_low()</a> , <a href="#">output_float()</a> , <a href="#">output_bit()</a> , <a href="#">output_x()</a> , <a href="#">#USE FIXED_IO</a> , <a href="#">#USE FAST_IO</a> , <a href="#">#USE STANDARD_IO</a> , <a href="#">General Purpose I/O</a>   |

## output\_low( )

|                |  |
|----------------|--|
| Syntax:        | output_low ( <i>pin</i> )  |
| Parameters:    | <b>Pins</b> are defined in the devices .h file. The actual value is a bit address. For example, port a (byte 0x2C2 ) bit 3 would have a value of 0x2C2*8+3 or 5651 . This is defined as follows: #DEFINE PIN_A3 5651 . The PIN could also be a variable. The variable must have a value equal to one of the constants (like PIN_A1) to work properly. The tristate register is updated unless the FAST_IO mode is set on port A. Note that doing I/O with a variable instead of a constant will take much longer time. |
| Returns:       | undefined  |
| Function:      | Sets a given pin to the ground state. The method of I/O used is dependent on the last USE *_IO directive.  |
| Availability:  | All devices.   |
| Requires:      | Pin constants are defined in the devices .h file   |
| Examples:      | output_low(PIN_A0);<br><br>Int16i=PIN_A1;<br>output_low(PIN_A1);   |
| Example Files: | <a href="#">ex_sqw.c</a>   |
| Also See:      | <a href="#">input()</a> , <a href="#">output_high()</a> , <a href="#">output_float()</a> , <a href="#">output_bit()</a> , <a href="#">output_x()</a> , <a href="#">#USE FIXED_IO</a> , <a href="#">#USE FAST_IO</a> , <a href="#">#USE STANDARD_IO</a> , <a href="#">General Purpose I/O</a>   |

## output\_toggle( )

|                |  |
|----------------|--|
| Syntax:        | output_toggle( <i>pin</i> )  |
| Parameters:    | Pins are defined in the devices .h file. The actual value is a bit address. For example, port a (byte 0x2C2 ) bit 3 would have a value of 0x2C2*8+3 or 5651 . This is defined as follows: #DEFINE PIN_A3 5651. |
| Returns:       | Undefined  |
| Function:      | Toggles the high/low state of the specified pin.   |
| Availability:  | All devices.   |
| Requires:      | Pin constants are defined in the devices .h file   |
| Examples:      | output_toggle(PIN_B4);   |
| Example Files: | None   |
| Also See:      | <a href="#">Input()</a> , <a href="#">output_high()</a> , <a href="#">output_low()</a> , <a href="#">output_bit()</a> , <a href="#">output_x()</a>   |

## perror( )

|                |   |
|----------------|---|
| Syntax:        | perror( <i>string</i> );  |
| Parameters:    | <b>string</b> is a constant string or array of characters (null terminated).  |
| Returns:       | Nothing   |
| Function:      | This function prints out to STDERR the supplied string and a description of the last system error (usually a math error). |
| Availability:  | All devices.  |
| Requires:      | #USE RS232, #INCLUDE <errno.h>  |
| Examples:      | <pre>x = sin(y);  if(errno!=0)     perror("Problem in find_area");</pre>  |
| Example Files: | None  |
| Also See:      | <a href="#">RS232 I/O Overview</a>  |

## pmp\_address(address)

|               |  |
|---------------|--|
| Syntax:       | pmp_address ( <b>address</b> );  |
| Parameters:   | <b>address</b> - The address which is a 16 bit destination address value. This will setup the address register on the PMP module and is only used in Master mode.  |
| Returns:      | undefined  |
| Function:     | Configures the address register of the PMP module with the destination address during Master mode operation. The address can be either 14, 15 or 16 bits based on the multiplexing used for the Chip Select Lines 1 and 2. |
| Availability: | Only the devices with a built in Parallel Port module.   |
| Requires:     | Nothing.   |



Examples: `pmp_address( 0x2100); // Sets up Address register to 0x2100`

Example Files: None

Also See: [setup\\_pmp\(\)](#), [pmp\\_address\(\)](#), [pmp\\_read\(\)](#), [psp\\_read\(\)](#), [psp\\_write\(\)](#), [pmp\\_write\(\)](#), [psp\\_output\\_full\(\)](#), [psp\\_input\\_full\(\)](#), [psp\\_overflow\(\)](#), [pmp\\_output\\_full\(\)](#), [pmp\\_input\\_full\(\)](#), [pmp\\_overflow\(\)](#).  
See header file for device selected.

## **pmp\_output\_full( )**

## **pmp\_input\_full( )**

## **pmp\_overflow( )**

## **pmp\_error( )**

## **pmp\_timeout( )**

Syntax: `result = pmp_output_full()` //PMP only  
`result = pmp_input_full()` //PMP only  
`result = pmp_overflow()` //PMP only  
`result = pmp_error( )` //EPMP only  
`result = pmp_timeout( )` //EPMP only

Parameters: None

Returns: A 0 (FALSE) or 1 (TRUE)

Function: These functions check the Parallel Port for the indicated conditions and return TRUE or FALSE.

Availability: This function is only available on devices with Parallel Port hardware on chips.

Requires: Nothing.

Examples: 

```
while (pmp_output_full() ) ;
pmp_data = command;
while(!pmp_input_full() ) ;
if ( pmp_overflow() )
    error = TRUE;
else
    data = pmp_data;
```

Example Files: None

Also See: [setup\\_pmp\(\)](#), [pmp\\_write\(\)](#), [pmp\\_read\(\)](#)

## pmp\_read( )

|                |   |
|----------------|---|
| Syntax:        | <pre> result = pmp_read ( );           //Parallel Master Port result = pmp_read8(address);    //Enhanced Parallel Master Port result = pmp_read16(address);   //Enhanced Parallel Master Port pmp_read8(address,pointer,count); //Enhanced Parallel Master Port pmp_read16(address,pointer,count); //Enhanced Parallel Master Port </pre>   |
| Parameters:    | <p><b>address</b>- EPMP only, address in EDS memory that is mapped to address from parallel port device to read data from or start reading data from. (All address in EDS memory are word aligned)</p> <p><b>pointer</b>- EPMP only, pointer to array to read data to.</p> <p><b>count</b>- EPMP only, number of bytes to read. For pmp_read16( ) number of bytes must be even.</p>   |
| Returns:       | For pmp_read( ), pmp_read8(address) or pmp_read16( ) an 8 or 16 bit value. For pmp_read8(address,pointer,count) and pmp_read16(address,pointer,count) undefined.  |
| Function:      | For PMP module, this will read a byte from the next buffer location. For EPMP module, reads one byte/word or count bytes of data from the address mapped to the EDS memory location. The address is used in conjunction with the offset address set with the setup_pmp_cs1( ) and setup_pmp_cs2( ) functions to determine which address lines are high or low during the read.  |
| Availability:  | Only the devices with a built in Parallel Master Port module or an Enhanced Parallel Master Port module.  |
| Requires:      | Nothing.  |
| Examples:      | <pre> result = pmp_read();           //PMP reads next byte of data result = pmp_read8(0x8000);    //EPMP reads byte of data from the address mapped                //to first address in EDS memory.                                 //EPMP reads 16 bytes of data and pmp_read16(0x8002,ptr,16);    //returns to array                                 //pointed to by ptr starting at                                 //address mapped                                 //to address 0x8002 in EDS memory. </pre>  |
| Example Files: | None  |
| Also See:      | <a href="#">setup_pmp()</a> , <a href="#">setup_pmp_csx()</a> , <a href="#">pmp_address()</a> , <a href="#">pmp_read()</a> , <a href="#">psp_read()</a> , <a href="#">psp_write()</a> , <a href="#">pmp_write()</a> , <a href="#">psp_output_full()</a> , <a href="#">psp_input_full()</a> , <a href="#">psp_overflow()</a> , <a href="#">pmp_output_full()</a> , <a href="#">pmp_input_full()</a> , <a href="#">pmp_overflow()</a> , <a href="#">pmp_error()</a> , <a href="#">pmp_timeout()</a> , <a href="#">psp_error()</a> , <a href="#">psp_timeout()</a> |

## pmp\_write( )

Syntax:           pmp\_write(**data**);                                 //Parallel Master Port  
                   pmp\_write8(**address,data**);                     //Enhanced Parallel Master Port  
                   pmp\_write8(**address,pointer,data**);            //Enhanced Parallel Master Port  
                   pmp\_write16(**address,data**);                    //Enhanced Parallel Master Port  
                   pmp\_write16(**address,pointer,data**);           //Enhanced Parallel Master Port

Parameters:   **data**- The byte of data to be written.

**address**- EPMP only, address in EDS memory that is mapped to address from parallel port device to write data to or start writing data to. (All addresses in EDS memory are word aligned)

**pointer**- EPMP only, pointer to data to be written

**count**- EPMP only, number of bytes to write. For pmp\_write16( ) number of bytes must be even.

Returns:       Undefined.

Function:      For PMP modules, this will write a byte of data to the next buffer location. For EPMP modules writes one byte/word or count bytes of data from the address mapped to the EDS memory location. The address is used in conjunction with the offset address set with the setup\_pmp\_cs1( ) and setup\_pmp\_cs2( ) functions to determine which address lines are high or low during write.

Availability:   Only the devices with a built in Parallel Master Port module or Enhanced Parallel Master Port modules.

Requires:      Nothing.

Examples:      pmp\_write( data );                                 //Write the data byte to the next  
                   buffer location.  
                   pmp\_write8(0x8000,data);                     //EPMP writes the data byte to the  
                   address mapped to                                 //the first location in EDS memory.  
                   pmp\_write16(0x8002,ptr,16);                 //EPMP writes 16 bytes of data  
                   pointed to by ptr                                //starting at address mapped to  
                   address 0x8002 in                                //EDS Memory

Example Files:   None

Also See:      [setup\\_pmp\(\)](#), [setup\\_pmp\\_csx\(\)](#), [pmp\\_address\(\)](#), [pmp\\_read\(\)](#), [psp\\_read\(\)](#),  
                   [psp\\_write\(\)](#), [pmp\\_write\(\)](#), [psp\\_output\\_full\(\)](#), [psp\\_input\\_full\(\)](#), [psp\\_overflow\(\)](#),  
                   [pmp\\_output\\_full\(\)](#), [pmp\\_input\\_full\(\)](#), [pmp\\_overflow\(\)](#), [pmp\\_error\(\)](#), [pmp\\_timeout\(\)](#),  
                   [psp\\_error\(\)](#), [psp\\_timeout\(\)](#)

## port\_x\_pullups ( )

Syntax:           port\_a\_pullups (**value**)  
                   port\_b\_pullups (**value**)  
                   port\_d\_pullups (**value**)  
                   port\_e\_pullups (**value**)  
                   port\_j\_pullups (**value**)  
                   port\_x\_pullups (**upmask**)  
                   port\_x\_pullups (**upmask, downmask**)

Parameters:   **value** is TRUE or FALSE on most parts, some parts that allow pullups to be specified on individual pins permit an 8 bit int here, one bit for each port pin.  
**upmask** for ports that permit pullups to be specified on a pin basis. This mask indicates what pins should have pullups activated. A 1 indicates the pullups is on.  
**downmask** for ports that permit pulldowns to be specified on a pin basis. This mask indicates what pins should have pulldowns activated. A 1 indicates the pulldowns is on.

Returns:       undefined

Function:      Sets the input pullups. TRUE will activate, and a FALSE will deactivate.

Availability:   Only 14 and 16 bit devices (PCM and PCH). (Note: use SETUP\_COUNTERS on PCB parts).

Requires:      Nothing

Examples:      port\_a\_pullups (FALSE);

Example Files:   [ex\\_lcdkb.c](#), [kbd.c](#)

Also See:      [input\(\)](#), [input\\_x\(\)](#), [output\\_float\(\)](#)

## pow( ) pwr( )

Syntax:        f = pow (**x,y**)  
                   f = pwr (**x,y**)

Parameters:   **x** and **y** are any float type

Returns:       A float with precision equal to function parameters x and y.

Function:      Calculates X to the Y power.

Note on error handling:

If "errno.h" is included then the domain and range errors are stored in the errno variable. The user can check the errno to see if an error has occurred and print

the error using the perror function.

Range error occurs in the following case:

- pow: when the argument X is negative

Availability: All Devices

Requires: #INCLUDE <math.h>

Examples: `area = pow (size,3.0);`

Example Files: None

Also See: None

## printf( ) fprintf( )

Syntax: `printf (string)`  
 or  
`printf (cstring, values...)`  
 or  
`printf (fname, cstring, values...)`  
`fprintf (stream, cstring, values...)`

Parameters: **String** is a constant string or an array of characters null terminated. **Values** is a list of variables separated by commas, **fname** is a function name to be used for outputting (default is putc is none is specified). **Stream** is a stream identifier (a constant byte). Note that format specifiers do not work in ram band strings.

Returns: undefined

Function: Outputs a string of characters to either the standard RS-232 pins (first two forms) or to a specified function. Formatting is in accordance with the string argument. When variables are used this string must be a constant. The % character is used within the string to indicate a variable value is to be formatted and output. Longs in the printf may be 16 or 32 bit. A %% will output a single %. Formatting rules for the % follows.

See the Expressions > Constants and Trigraph sections of this manual for other escape character that may be part of the string.

If fprintf() is used then the specified stream is used where printf() defaults to STDOUT (the last USE RS232).

Format:

The format takes the generic form %nt. n is optional and may be 1-9 to specify how many characters are to be outputted, or 01-09 to indicate leading zeros, or 1.1 to 9.9 for floating point and %w output. t is the type and may be one of the following:

|    |  |
|----|--|
| c  | Character  |
| s  | String or character  |
| u  | Unsigned int   |
| d  | Signed int   |
| Lu | Long unsigned int  |
| Ld | Long signed int  |
| x  | Hex int (lower case)   |
| X  | Hex int (upper case)   |
| Lx | Hex long int (lower case)  |
| LX | Hex long int (upper case)  |
| f  | Float with truncated decimal   |
| g  | Float with rounded decimal   |
| e  | Float in exponential format  |
| w  | Unsigned int with decimal place inserted. Specify two numbers for n. The first is a total field width. The second is the desired number of decimal places. |

Example formats:

| Specifier | Value=0x12 | Value=0xfe |
|-----------|------------|------------|
| %03u      | 018        | 254        |
| %u        | 18         | 254        |
| %2u       | 18         | *          |
| %5        | 18         | 254        |
| %d        | 18         | -2         |
| %x        | 12         | fe         |
| %X        | 12         | FE         |
| %4X       | 0012       | 00FE       |
| %3.1w     | 1.8        | 25.4       |

\* Result is undefined - Assume garbage.

Availability: All Devices

Requires: #USE RS232 (unless fframe is used)

Examples: 

```
byte x,y,z;
printf("HiThere");
printf("RTCCValue=>%2x\n\r",get_rtcc());
printf("%2u %X %4X\n\r",x,y,z);
printf(LCD_PUTC, "n=%u",n);
```

Example Files: [ex\\_admm.c](#), [ex\\_lcdkb.c](#)

Also See: [atoi\(\)](#), [puts\(\)](#), [putc\(\)](#), [getc\(\)](#) (for a stream example), [RS232 I/O Overview](#)

## [psp\\_output\\_full\( \)](#) [psp\\_input\\_full\( \)](#) [psp\\_overflow\( \)](#) [psp\\_error\( \)](#) [psp\\_timeout\( \)](#)

Syntax:            result = psp\_output\_full()  
                   result = psp\_input\_full()  
                   result = psp\_overflow()  
                   result = psp\_error();                    //EPMP only  
                   result = psp\_timeout();                 //EPMP only

Parameters:       None

Returns:           A 0 (FALSE) or 1 (TRUE)

Function:          These functions check the Parallel Slave Port (PSP) for the indicated conditions and return TRUE or FALSE.

Availability:      This function is only available on devices with PSP hardware on chips.

Requires:          Nothing

Examples:          

```
while (psp_output_full()) ;
psp_data = command;
while (!psp_input_full()) ;
if ( psp_overflow() )
    error = TRUE;
else
    data = psp_data;
```

Example            [ex\\_psp.c](#)

Files:

Also See:          [setup\\_psp\(\)](#), PSP Overview

## [psp\\_read\( \)](#)

Syntax:            Result = psp\_read ( );  
                   Result = psp\_read ( **address** );

Parameters:        **address**- The address of the buffer location that needs to be read. If address is not specified, use the function psp\_read() which will read the next buffer location.

Returns:           A byte of data.

Function:          psp\_read() will read a byte of data from the next buffer location and psp\_read ( **address** ) will read the buffer location **address**.

## TEST PCD

Availability: Only the devices with a built in Parallel Master Port module of Enhanced Parallel Master Port module.

Requires: Nothing.

Examples: 

```
Result = psp_read(); // Reads next byte of data
Result = psp_read(3); // Reads the buffer location 3
```

Example Files: None

Also See: [setup\\_pmp\(\)](#), [pmp\\_address\(\)](#), [pmp\\_read\(\)](#), [psp\\_read\(\)](#), [psp\\_write\(\)](#), [pmp\\_write\(\)](#), [psp\\_output\\_full\(\)](#), [psp\\_input\\_full\(\)](#), [psp\\_overflow\(\)](#), [pmp\\_output\\_full\(\)](#), [pmp\\_input\\_full\(\)](#), [pmp\\_overflow\(\)](#).  
See header file for device selected.

## psp\_write( )

Syntax: 

```
psp_write ( data );
psp_write( address, data );
```

Parameters: **address**-The buffer location that needs to be written to  
**data**- The byte of data to be written

Returns: Undefined.

Function: This will write a byte of data to the next buffer location or will write a byte to the specified buffer location.

Availability: Only the devices with a built in Parallel Master Port module or Enhanced Parallel Master Port module.

Requires: Nothing.

Examples: 

```
psp_write( data ); // Write the data byte to the next buffer
location.
```

Example Files: None

Also See: [setup\\_pmp\(\)](#), [pmp\\_address\(\)](#), [pmp\\_read\(\)](#), [psp\\_read\(\)](#), [psp\\_write\(\)](#), [pmp\\_write\(\)](#), [psp\\_output\\_full\(\)](#), [psp\\_input\\_full\(\)](#), [psp\\_overflow\(\)](#), [pmp\\_output\\_full\(\)](#), [pmp\\_input\\_full\(\)](#), [pmp\\_overflow\(\)](#).  
See header file for device selected.



## putc( ) putchar( ) fputc( )

Syntax:            `putc ( cdata )`  
                   `putchar ( cdata )`  
                   `fputc( cdata, stream )`

Parameters:        ***cdata*** is a 8 bit character. ***Stream*** is a stream identifier (a constant byte)

Returns:            undefined

Function:           This function sends a character over the RS232 XMIT pin. A #USE RS232 must appear before this call to determine the baud rate and pin used. The #USE RS232 remains in effect until another is encountered in the file.

If fputc() is used then the specified stream is used where putc() defaults to STDOUT (the last USE RS232).

Availability:      All devices

Requires:          #USE RS232

Examples:          

```
putc('*');
for(i=0; i<10; i++)
    putc(buffer[i]);
putc(13);
```

Example Files:     [ex\\_tgetc.c](#)

Also See:          [getc\(\)](#), [printf\(\)](#), [#USE RS232](#), [RS232 I/O Overview](#)

## puts( ) fputs( )

Syntax:            `puts ( string )`  
                   `fputs ( string, stream )`

Parameters:        ***string*** is a constant string or a character array (null-terminated). ***Stream*** is a stream identifier (a constant byte)

Returns:            undefined

Function:           Sends each character in the string out the RS232 pin using putc(). After the string is sent a RETURN (13) and LINE-FEED (10) are sent. In general printf() is more useful than puts().

If fputs() is used then the specified stream is used where puts() defaults to STDOUT (the last USE RS232)

Availability:      All devices

Requires:          #USE RS232

## TEST PCD

Examples:        `puts ( " ----- " );`  
                  `puts ( " | HI | " );`  
                  `puts ( " ----- " );`

Example Files:        None

Also See:            [printf\(\)](#), [gets\(\)](#), [RS232 I/O Overview](#)

## qei\_get\_count( )

Syntax:              `value = qei_get_count( [unit] );`

Parameters:        **value**- The 16-bit value of the position counter.  
                      **unit**- Optional unit number, defaults to 1.

Returns:             void

Function:            Reads the current 16-bit value of the position counter.

Availability:        Devices that have the QEI module.

Requires:            Nothing.

Examples:            `value = qei_get_counter();`

Example Files:        None

Also See:            [setup\\_qei\(\)](#), [qei\\_set\\_count\(\)](#), [qei\\_status\(\)](#).

## qei\_set\_count( )

Syntax:              `qei_set_count( [unit], value );`

Parameters:        **value**- The 16-bit value of the position counter.  
                      **unit**- Optional unit number, defaults to 1.

Returns:             void

Function:            Write a 16-bit value to the position counter.

Availability:        Devices that have the QEI module.

Requires:            Nothing.

Examples:            `qei_set_counter(value);`

Example Files:        None

Also See:            [setup\\_qei\(\)](#), [qei\\_get\\_count\(\)](#), [qei\\_status\(\)](#).

## qei\_status( )

|                |  |
|----------------|--|
| Syntax:        | <code>status = qei_status( [<i>unit</i>] );</code>   |
| Parameters:    | <b>status</b> - The status of the QEI module<br><b>unit</b> - Optional unit number, defaults to 1. |
| Returns:       | void   |
| Function:      | Returns the status of the QEI module.  |
| Availability:  | Devices that have the QEI module.  |
| Requires:      | Nothing.   |
| Examples:      | <code>status = qei_status();</code>  |
| Example Files: | None   |
| Also See:      | <a href="#">setup_qei()</a> , <a href="#">qei_set_count()</a> , <a href="#">qei_get_count()</a> .  |

## qsort( )

|                |   |
|----------------|---|
| Syntax:        | <code>qsort (<i>base, num, width, compare</i>)</code>   |
| Parameters:    | <b>base</b> : Pointer to array of sort data<br><b>num</b> : Number of elements<br><b>width</b> : Width of elements<br><b>compare</b> : Function that compares two elements  |
| Returns:       | None  |
| Function:      | Performs the shell-metzner sort (not the quick sort algorithm). The contents of the array are sorted into ascending order according to a comparison function pointed to by compare.   |
| Availability:  | All devices   |
| Requires:      | <code>#INCLUDE &lt;stdlib.h&gt;</code>  |
| Examples:      | <pre>int nums[5]={ 2,3,1,5,4}; int compar(void *arg1,void *arg2);  void main() {     qsort ( nums, 5, sizeof(int), compar); }  int compar(void *arg1,void *arg2) {     if ( * (int *) arg1 &lt; ( * (int *) arg2) return -1     else if ( * (int *) arg1 == ( * (int *) arg2) return 0     else return 1; }</pre> |
| Example Files: | <a href="#">ex_qsort.c</a>  |
| Also See:      | <a href="#">bsearch()</a>   |

## rand( )

Syntax: `re=rand()`

Parameters: None

Returns: A pseudo-random integer.

Function: The rand function returns a sequence of pseudo-random integers in the range of 0 to RAND\_MAX.

Availability: All devices

Requires: `#INCLUDE <STDLIB.H>`

Examples: 

```
int I;
I=rand();
```

Example Files: None

Also See: [srand\(\)](#)

## read\_adc( ) read\_adc2( )

Syntax: `value = read_adc ([mode])`  
`value = read_adc2 ([mode])`

Parameters: **mode** is an optional parameter. If used the values may be:  
 ADC\_START\_AND\_READ (continually takes readings, this is the default)  
 ADC\_START\_ONLY (starts the conversion and returns)  
 ADC\_READ\_ONLY (reads last conversion result)

Returns: Either a 8 or 16 bit int depending on #DEVICE ADC= directive.

Function: This function will read the digital value from the analog to digital converter. Calls to `setup_adc()`, `setup_adc_ports()` and `set_adc_channel()` should be made sometime before this function is called. The range of the return value depends on number of bits in the chips A/D converter and the setting in the #DEVICE ADC= directive as follows:

| #DEVICE | 10 bit | 12 bit |
|---------|--------|--------|
| ADC=8   | 00-FF  | 00-FF  |
| ADC=10  | 0-3FF  | 0-3FF  |
| ADC=11  | x      | x      |
| ADC=12  | 0-FFC  | 0-FFF  |

ADC=16                      0-FFC0                      0-FFF0

Note: *x* is not defined

Availability: Only available on devices with built in analog to digital converters.

Requires: Pin constants are defined in the devices .h file.

Examples:

```
int16 value;
setup_adc_ports(sAN0|sAN1, VSS_VDD);
setup_adc(ADC_CLOCK_DIV_4|ADC_TAD_MUL_8);

while (TRUE)
{
    set_adc_channel(0);
    value = read_adc();
    printf("Pin AN0 A/C value = %LX\n\r", value);

    delay_ms(5000);

    set_adc_channel(1);
    read_adc(ADC_START_ONLY);
    ...
    value = read_adc(ADC_READ_ONLY);
    printf("Pin AN1 A/D value = %LX\n\r", value);
}
```

Example Files: [ex\\_admm.c](#),

## read\_configuration\_memory( )

Syntax: read\_configuration\_memory(*ramPtr*, *n*)

Parameters: ***ramPtr*** is the destination pointer for the read results  
***count*** is an 8 bit integer

Returns: undefined

Function: Reads *n* bytes of configuration memory and saves the values to ***ramPtr***.

Availability: All

Requires: Nothing

Examples:

```
int data[6];
read_configuration_memory(data, 6);
```

Example Files: None

Also See: [write\\_configuration\\_memory\(\)](#), [read\\_program\\_memory\(\)](#), [Configuration Memory Overview](#)

## read\_eeprom( )

Syntax:           value = read\_eeprom (**address** , [**N**] )  
                   read\_eeprom( **address** , **variable** )  
                   read\_eeprom( **address** , **pointer** , **N** )

Parameters:   **address** is an (8 bit or 16 bit depending on the part) int  
**N** specifies the number of EEPROM bytes to read  
**variable** a specified location to store EEPROM read results  
**pointer** is a pointer to location to store EEPROM read results

Returns:       An 16 bit int

Function:      By default the function reads a word from EEPROM at the specified address. The number of bytes to read can optionally be defined by argument N. If a variable is used as an argument, then EEPROM is read and the results are placed in the variable until the variable data size is full. Finally, if a pointer is used as an argument, then n bytes of EEPROM at the given address are read to the pointer.

Availability:   This command is only for parts with built-in EEPROMS

Requires:      Nothing

Examples:      

```
#define LAST_VOLUME 10
volume = read_EEPROM (LAST_VOLUME);
```

Example Files:   None

Also See:      [write\\_eeprom\(\)](#), [Data Eeprom Overview](#)

## read\_extended\_ram( )

Syntax:           read\_extended\_ram(**page,address,data,count**);

Parameters:   **page** – the page in extended RAM to read from  
**address** – the address on the selected page to start reading from  
**data** – pointer to the variable to return the data to  
**count** – the number of bytes to read (0-32768)

Returns:       Undefined

Function:      To read data from the extended RAM of the PIC.

Availability:   On devices with more then 30K of RAM.

Requires:      Nothing

Examples:      

```
unsigned int8 data[8];
read_extended_ram(1,0x0000,data,8);
```

Example Files:   None

Also See:      [read\\_extended\\_ram\(\)](#), [Extended RAM Overview](#)

## read\_high\_speed\_adc( )

|               |  |
|---------------|--|
| Syntax:       | <pre>read_high_speed_adc(pair,mode,result); // Individual start and read or // read only read_high_speed_adc(pair,result); // Individual start and read read_high_speed_adc(pair); // Individual start only read_high_speed_adc(mode,result); // Global start and read or // read only read_high_speed_adc(result); // Global start and read read_high_speed_adc(); // Global start only</pre>   |
| Parameters:   | <p><b>pair</b> – Optional parameter that determines which ADC pair number to start and/or read. Valid values are 0 to total number of ADC pairs. 0 starts and/or reads ADC pair AN0 and AN1, 1 starts and/or reads ADC pair AN2 and AN3, etc. If omitted then a global start and/or read will be performed.</p> <p><b>mode</b> – Optional parameter, if used the values may be:</p> <ul style="list-style-type: none"><li>▪ ADC_START_AND_READ (starts conversion and reads result)</li><li>▪ ADC_START_ONLY (starts conversion and returns)</li><li>▪ ADC_READ_ONLY (reads conversion result)</li></ul> <p><b>result</b> – Pointer to return ADC conversion too. Parameter is optional, if not used the read_fast_adc() function can only perform a start.</p>  |
| Returns:      | Undefined  |
| Function:     | <p>This function is used to start an analog to digital conversion and/or read the digital value when the conversion is complete. Calls to setup_high_speed_adc() and setup_high_speed_adc_pairs() should be made sometime before this function is called.</p> <p>When using this function to perform an individual start and read or individual start only, the function assumes that the pair's trigger source was set to INDIVIDUAL_SOFTWARE_TRIGGER.</p> <p>When using this function to perform a global start and read, global start only, or global read only. The function will perform the following steps:</p> <ol style="list-style-type: none"><li>1. Determine which ADC pairs are set for GLOBAL_SOFTWARE_TRIGGER.</li><li>2. Clear the corresponding ready flags (if doing a start).</li><li>3. Set the global software trigger (if doing a start).</li><li>4. Read the corresponding ADC pairs in order from lowest to highest (if doing a read).</li><li>5. Clear the corresponding ready flags (if doing a read).</li></ol> <p>When using this function to perform a individual read only. The function can read the ADC result from any trigger source.</p> |
| Availability: | Only on devices with a built-in high-speed analog to digital converter.  |

|                |   |
|----------------|---|
| Requires:      | Constants are define in the device .h file.   |
| Examples:      | <pre>//Individual start and read int16 result[2];  setup_high_speed_adc(ADC_CLOCK_DIV_4); setup_high_speed_adc_pair(0,     INDIVIDUAL_SOFTWARE_TRIGGER); read_high_speed_adc(0, result); //starts conversion for AN0 and AN1 and stores                                 //result in result[0] and result[1]  //Global start and read int16 result[4];  setup_high_speed_adc(ADC_CLOCK_DIV_4); setup_high_speed_adc_pair(0, GLOBAL_SOFTWARE_TRIGGER); setup_high_speed_adc_pair(4, GLOBAL_SOFTWARE_TRIGGER); read_high_speed_adc(result); //starts conversion for AN0, AN1, AN8 and AN9 and                                 //stores result in result[0], result[1], result[2] and                                 //result[3]</pre> |
| Example Files: | None  |
| Also See:      | <a href="#">setup_high_speed_adc()</a> , <a href="#">setup_high_speed_adc_pair()</a> , <a href="#">high_speed_adc_done()</a>  |

## read\_program\_memory( )

Syntax: READ\_PROGRAM\_MEMORY (**address**, **dataptr**, **count**);

Parameters: **address** is 32 bits . The least significant bit should always be 0 in PCM.  
**dataptr** is a pointer to one or more bytes.  
**count** is a 16 bit integer on PIC16 and 16-bit for PIC18

Returns: undefined

Function: Reads **count** bytes from program memory at **address** to RAM at **dataptr**.  
 BDue to the 24 bit program instruction size on the PCD devices, every fourth byte will be read as 0x00

Availability: Only devices that allow reads from program memory.

Requires: Nothing

Examples:

```
char buffer[64];
read_external_memory(0x40000, buffer, 64);
```

Example Files: None

Also See: [write\\_program\\_memory\(\)](#), [Program Eeprom Overview](#)



## read\_rom\_memory( )

Syntax: `READ_ROM_MEMORY (address, dataptr, count);`

Parameters: ***address*** is 32 bits. The least significant bit should always be 0.  
***dataptr*** is a pointer to one or more bytes.  
***count*** is a 16 bit integer

Returns: undefined

Function: Reads ***count*** bytes from program memory at ***address*** to ***dataptr***. Due to the 24 bit program instruction size on the PCD devices, three bytes are read from each address location.

Availability: Only devices that allow reads from program memory.

Requires: Nothing

Examples: 

```
char buffer[64];
read_program_memory(0x40000, buffer, 64);
```

Example Files: None

Also See: [write\\_eeprom\(\)](#), [read\\_eeprom\(\)](#), [Program eeprom overview](#)

## realloc( )

Syntax: `realloc (ptr, size)`

Parameters: ***ptr*** is a null pointer or a pointer previously returned by `calloc` or `malloc` or `realloc` function, ***size*** is an integer representing the number of bytes to be allocated.

Returns: A pointer to the possibly moved allocated memory, if any. Returns null otherwise.

Function: The `realloc` function changes the size of the object pointed to by the `ptr` to the size specified by the `size`. The contents of the object shall be unchanged up to the lesser of new and old sizes. If the new size is larger, the value of the newly allocated space is indeterminate. If `ptr` is a null pointer, the `realloc` function behaves like `malloc` function for the specified size. If the `ptr` does not match a pointer earlier returned by the `calloc`, `malloc` or `realloc`, or if the space has been deallocated by a call to `free` or `realloc` function, the behavior is undefined. If the space cannot be allocated, the object pointed to by `ptr` is unchanged. If `size` is zero and the `ptr` is not a null pointer, the object is to be freed.

## TEST PCD

Availability: All devices

Requires: #INCLUDE <stdlib.h>

Examples: 

```
int * iptr;
iptr=malloc(10);
realloc(iptr,20)

// iptr will point to a block of memory of 20 bytes, if
available.
```

Example Files: None

Also See: [malloc\(\)](#), [free\(\)](#), [calloc\(\)](#)

## reset\_cpu( )

Syntax: reset\_cpu()

Parameters: None

Returns: This function never returns

Function: This is a general purpose device reset. It will jump to location 0 on PCB and PCM parts and also reset the registers to power-up state on the PIC18XXX.

Availability: All devices

Requires: Nothing

Examples: 

```
if(checksum!=0)
    reset_cpu();
```

Example Files: None

Also See: None

## restart\_cause( )

Syntax: value = restart\_cause()

Parameters: None

**Returns:** A value indicating the cause of the last processor reset. The actual values are device dependent. See the device .h file for specific values for a specific device. Some example values are: RESTART\_POWER\_UP, RESTART\_BROWNOUT, RESTART\_WDT and RESTART\_MCLR

**Function:** Returns the cause of the last processor reset.

In order for the result to be accurate, it should be called immediately in main().

**Availability:** All devices

**Requires:** Constants are defined in the devices .h file.

**Examples:**

```
switch ( restart_cause() ) {
    case RESTART_BROWNOUT:
    case RESTART_WDT:
    case RESTART_MCLR:
        handle_error();
}
```

**Example Files:** [ex\\_wdt.c](#)

**Also See:** [restart\\_wdt\(\)](#), [reset\\_cpu\(\)](#)

## restart\_wdt( )

**Syntax:** restart\_wdt()

**Parameters:** None

**Returns:** undefined

**Function:** Restarts the watchdog timer. If the watchdog timer is enabled, this must be called periodically to prevent the processor from resetting.

The watchdog timer is used to cause a hardware reset if the software appears to be stuck.

The timer must be enabled, the timeout time set and software must periodically restart the timer. These are done differently on the PCB/PCM and PCH parts as follows:

|                |         |             |
|----------------|---------|-------------|
|                | PCB/PCM | PCH         |
| Enable/Disable | #fuses  | setup_wdt() |

## TEST PCD

|  |                         |                              |                         |
|--|-------------------------|------------------------------|-------------------------|
|  | Timeout time<br>restart | setup_wdt()<br>restart_wdt() | #fuses<br>restart_wdt() |
|--|-------------------------|------------------------------|-------------------------|

Availability: All devices

Requires: #FUSES

Examples:

```
#fuses WDT // PCB/PCM example
           // See setup_wdt for a PIC18 example

main() {
    setup_wdt(WDT_2304MS);
    while (TRUE) {
        restart_wdt();
        perform_activity();
    }
}
```

Example Files: [ex\\_wdt.c](#)

Also See: [#FUSES](#), [setup\\_wdt\(\)](#), [WDT or Watch Dog Timer Overview](#)

## rotate\_left( )

Syntax: rotate\_left (**address**, **bytes**)

Parameters: **address** is a pointer to memory, **bytes** is a count of the number of bytes to work with.

Returns: undefined

Function: Rotates a bit through an array or structure. The address may be an array identifier or an address to a byte or structure (such as &data). Bit 0 of the lowest BYTE in RAM is considered the LSB.

Availability: All devices

Requires: Nothing

Examples:

```
x = 0x86;
rotate_left( &x, 1);
// x is now 0x0d
```

Example Files: None

Also See: [rotate\\_right\(\)](#), [shift\\_left\(\)](#), [shift\\_right\(\)](#)

## rotate\_right( )

**Syntax:** rotate\_right (*address*, *bytes*)

**Parameters:** *address* is a pointer to memory, *bytes* is a count of the number of bytes to work with.

**Returns:** undefined

**Function:** Rotates a bit through an array or structure. The address may be an array identifier or an address to a byte or structure (such as &data). Bit 0 of the lowest BYTE in RAM is considered the LSB.

**Availability:** All devices

**Requires:** Nothing

**Examples:**

```

struct {
    int cell_1 : 4;
    int cell_2 : 4;
    int cell_3 : 4;
    int cell_4 : 4; } cells;
rotate_right( &cells, 2);
rotate_right( &cells, 2);
rotate_right( &cells, 2);
rotate_right( &cells, 2);
// cell_1->4, 2->1, 3->2 and 4-> 3

```

**Example** None

**Files:**

**Also See:** [rotate\\_left\(\)](#), [shift\\_left\(\)](#), [shift\\_right\(\)](#)

## rtc\_alarm\_read( )

**Syntax:** rtc\_alarm\_read(&*datetime*);

**Parameters:** *datetime*- A structure that will contain the values to be written to the alarm in the RTCC module.

Structure used in read and write functions are defined in the device header file.

**Returns:** void

**Function:** Reads the date and time from the alarm in the RTCC module to *datetime*.

**Availability:** Devices that have the RTCC module.

**Requires:** Nothing.

## TEST PCD

Examples: `rtc_alarm_read(&datetime);`

Example None

Files:

Also See: [rtc\\_read\(\)](#), [rtc\\_alarm\\_read\(\)](#), [rtc\\_alarm\\_write\(\)](#), [setup\\_rtc\\_alarm\(\)](#), [rtc\\_write\(\)](#), [setup\\_rtc\(\)](#)

## rtc\_alarm\_write( )

Syntax: `rtc_alarm_write(&datetime);`

Parameters: **datetime**- A structure that will contain the values to be written to the alarm in the RTCC module.

Structure used in read and write functions are defined in the device header file.

Returns: void

Function: Writes the date and time to the alarm in the RTCC module as specified in the structure `time_t`.

Availability: Devices that have the RTCC module.

Requires: Nothing.

Examples: `rtc_alarm_write(&datetime);`

Example None

Files:

Also See: [rtc\\_read\(\)](#), [rtc\\_alarm\\_read\(\)](#), [rtc\\_alarm\\_write\(\)](#), [setup\\_rtc\\_alarm\(\)](#), [rtc\\_write\(\)](#), [setup\\_rtc\(\)](#)

## rtc\_read( )

Syntax: `rtc_read(&datetime);`

Parameters: **datetime**- A structure that will contain the values returned by the RTCC module.

Structure used in read and write functions are defined in the device header file.

Returns: void

Function: Reads the current value of Time and Date from the RTCC module and stores it in a structure `time_t`.

Availability: Devices that have the RTCC module.

Requires: Nothing.

Examples: `rtc_read(&datetime);`

Example [ex\\_rtcc.c](#)

Files:

Also See: [rtc\\_read\(\)](#), [rtc\\_alarm\\_read\(\)](#), [rtc\\_alarm\\_write\(\)](#), [setup\\_rtc\\_alarm\(\)](#), [rtc\\_write\(\)](#), [setup\\_rtc\(\)](#)

## rtc\_write( )

Syntax: `rtc_write(&datetime);`

Parameters: ***datetime***- A structure that will contain the values to be written to the RTCC module.

Structure used in read and write functions are defined in the device header file.

Returns: void

Function: Writes the date and time to the RTCC module as specified in the structure `time_t`.

Availability: Devices that have the RTCC module.

Requires: Nothing.

Examples: `rtc_write(&datetime);`

Example Files: [ex\\_rtcc.c](#)

Files:

Also See: [rtc\\_read\(\)](#) , [rtc\\_alarm\\_read\(\)](#) , [rtc\\_alarm\\_write\(\)](#) , [setup\\_rtc\\_alarm\(\)](#) , [rtc\\_write\(\)](#), [setup\\_rtc\(\)](#)

## rtos\_await( )

The RTOS is only included in the PCW, PCWH and PCWHD software packages.

Syntax: `rtos_await (expre)`

Parameters: ***expre*** is a logical expression.

Returns: None

Function: This function can only be used in an RTOS task. This function waits for ***expre*** to be true before continuing execution of the rest of the code of the RTOS task. This function allows other tasks to execute while the task waits for ***expre*** to be true.

Availability: All devices

Requires: #USE\_RTOS

Examples: `rtos_await(kbhit());`

Also See: None

## rtos\_disable( )

The RTOS is only included in the PCW, PCWH, and PCWHD software packages.

Syntax: `rtos_disable (task)`

Parameters: ***task*** is the identifier of a function that is being used as an RTOS task.

Returns: None

## TEST PCD

**Function:** This function disables a task which causes the task to not execute until enabled by `rtos_enable()`. All tasks are enabled by default.

**Availability:** All devices

**Requires:** #USE RTOS

**Examples:** `rtos_disable(toggle_green)`

**Also See:** [rtos enable\(\)](#)

## rtos\_enable( )

The RTOS is only included in the PCW, PCWH, and PCWHD software packages.

**Syntax:** `rtos_enable(task)`

**Parameters:** *task* is the identifier of a function that is being used as an RTOS task.

**Returns:** None

**Function:** This function enables a task to execute at its specified rate.

**Availability:** All devices

**Requires:** #USE RTOS

**Examples:** `rtos_enable(toggle_green);`

**Also See:** [rtos disable\(\)](#)

## rtos\_msg\_poll( )

The RTOS is only included in the PCW, PCWH and PCWHD software packages.

**Syntax:** `i = rtos_msg_poll()`

**Parameters:** None

**Returns:** An integer that specifies how many messages are in the queue.

**Function:** This function can only be used inside an RTOS task. This function returns the number of messages that are in the queue for the task that the `rtos_msg_poll()` function is used in.

**Availability:** All devices



Requires: #USE RTOS

Examples: `if(rtos_msg_poll())`

Also See: [rtos\\_msg\\_send\(\)](#), [rtos\\_msg\\_read\(\)](#)

## rtos\_msg\_read( )

The RTOS is only included in the PCW, PCWH and PCWHD software packages.

Syntax: `b = rtos_msg_read()`

Parameters: None

Returns: A byte that is a message for the task.

Function: This function can only be used inside an RTOS task. This function reads in the next (message) of the queue for the task that the `rtos_msg_read()` function is used in.

Availability: All devices

Requires: #USE RTOS

Examples: 

```
if(rtos_msg_poll()) {
    b = rtos_msg_read();
}
```

Also See: [rtos\\_msg\\_poll\(\)](#), [rtos\\_msg\\_send\(\)](#)

## rtos\_msg\_send( )

The RTOS is only included in the PCW, PCWH and PCWHD software packages.

Syntax: `rtos_msg_send(task, byte)`

Parameters: **task** is the identifier of a function that is being used as an RTOS task  
**byte** is the byte to send to **task** as a message.

Returns: None

Function: This function can be used anytime after `rtos_run()` has been called. This function sends a byte long message (**byte**) to the task identified by **task**.

## TEST PCD

|               |   |
|---------------|---|
| Availability: | All devices   |
| Requires:     | #USE RTOS   |
| Examples:     | <pre>if(kbhit()) {     rtos_msg_send(echo, getc()); }</pre>       |
| Also See:     | <a href="#">rtos_msg_poll()</a> , <a href="#">rtos_msg_read()</a> |

## rtos\_overrun( )

The RTOS is only included in the PCW, PCWH and PCWHD software packages.

|               |   |
|---------------|---|
| Syntax:       | rtos_overrun( <b><i>task</i></b> )  |
| Parameters:   | <b><i>task</i></b> is an optional parameter that is the identifier of a function that is being used as an RTOS task   |
| Returns:      | A 0 (FALSE) or 1 (TRUE)   |
| Function:     | This function returns TRUE if the specified task took more time to execute than it was allocated. If no task was specified, then it returns TRUE if any task ran over it's allotted execution time. |
| Availability: | All devices   |
| Requires:     | #USE RTOS(statistics)   |
| Examples:     | <code>rtos_overrun()</code>   |
| Also See:     | None  |

## rtos\_run( )

The RTOS is only included in the PCW, PCWH, and PCWHD software packages.

|               |  |
|---------------|--|
| Syntax:       | rtos_run()   |
| Parameters:   | None   |
| Returns:      | None   |
| Function:     | This function begins the execution of all enabled RTOS tasks. This function controls the execution of the RTOS tasks at the allocated rate for each task. This function will return only when <code>rtos_terminate()</code> is called. |
| Availability: | All devices  |
| Requires:     | #USE RTOS  |
| Examples:     | <code>rtos_run()</code>  |
| Also See:     | <a href="#">rtos_terminate()</a>   |

## rtos\_signal( )

The RTOS is only included in the PCW, PCWH and PCWHD software packages.

|             |  |
|-------------|--|
| Syntax:     | rtos_signal ( <b><i>sem</i></b> )  |
| Parameters: | <b><i>sem</i></b> is a global variable that represents the current availability of a shared system resource (a semaphore). |

|               |  |
|---------------|--|
| Returns:      | None   |
| Function:     | This function can only be used by an RTOS task. This function increments <b>sem</b> to let waiting tasks know that a shared resource is available for use. |
| Availability: | All devices  |
| Requires:     | #USE RTOS  |
| Examples:     | <code>rtos_signal(uart_use)</code>   |
| Also See:     | <a href="#">rtos_wait()</a>  |

## rtos\_stats( )

The RTOS is only included in the PCW, PCWH and PCWHD software packages.

Syntax: `rtos_stats(task,&stat)`

Parameters: **task** is the identifier of a function that is being used as an RTOS task.  
**stat** is a structure containing the following:

```

struct rtos_stas_struct {
    unsigned int32 task_total_ticks; // number of ticks the task has
    used
    unsigned int16 task_min_ticks; // the minimum number of ticks
    used
    unsigned int16 task_max_ticks; // the maximum number of ticks
    used
    unsigned int16 hns_per_tick; // us = (ticks*hns_per_tick)/10
};

```

Returns: Undefined

Function: This function returns the statistic data for a specified **task**.

Availability: All devices

Requires: #USE RTOS(statistics)

Examples: `rtos_stats(echo, &stats)`

Also See: None

## rtos\_terminate( )

The RTOS is only included in the PCW, PCWH and PCWHD software packages.

Syntax: `rtos_terminate()`

Parameters: None

Returns: None

Function: This function ends the execution of all RTOS tasks. The execution of the program will continue with the first line of code after the `rtos_run()` call in the program. (This function causes `rtos_run()` to return.)

Availability: All devices

Requires: #USE RTOS

Examples: `rtos_terminate()`

Also See: [rtos\\_run\(\)](#)

## rtos\_wait( )

The RTOS is only included in the PCW, PCWH and PCWHD software packages.

Syntax: `rtos_wait (sem)`

Parameters: **sem** is a global variable that represents the current availability of a shared system resource (a semaphore).

Returns: None

Function: This function can only be used by an RTOS task. This function waits for **sem** to be greater than 0 (shared resource is available), then decrements **sem** to claim usage of the shared resource and continues the execution of the rest of the code the RTOS task. This function allows other tasks to execute while the task waits for the shared resource to be available.

Availability: All devices

Requires: #USE RTOS

Examples: `rtos_wait(uart_use)`

Also See: [rtos\\_signal\(\)](#)

## rtos\_yield( )

The RTOS is only included in the PCW, PCWH and PCWHD software packages.

Syntax: `rtos_yield()`

Parameters: None

Returns: None

Function: This function can only be used in an RTOS task. This function stops the execution of the current task and returns control of the processor to `rtos_run()`. When the next task executes, it will start its execution on the line of code after the `rtos_yield()`.

Availability: All devices

Requires: #USE RTOS

Examples: 

```
void yield(void)
{
    printf("Yielding...\r\n");
    rtos_yield();
    printf("Executing code after yield\r\n");
}
```

Also See: None

## set\_adc\_channel( )

## set\_adc\_channel2( )

Syntax: `set_adc_channel (chan [,neg])`  
`set_adc_channel2(chan)`

Parameters: ***chan*** is the channel number to select. Channel numbers start at 0 and are labeled in the data sheet AN0, AN1. For devices with a differential ADC it sets the positive channel to use.

***neg*** is optional and is used for devices with a differential ADC only. It sets the negative channel to use, channel numbers can be 0 to 6 or VSS. If no parameter is used the negative channel will be set to VSS by default.

Returns: undefined

Function: Specifies the channel to use for the next `read_adc()` call. Be aware that you must wait a short time after changing the channel before you can get a valid read. The time varies depending on the impedance of the input source. In general 10us is good for most applications. You need not change the channel before every read if the channel does not change.

Availability: Only available on devices with built in analog to digital converters

Requires: Nothing

Examples: `set_adc_channel(2);`  
`value = read_adc();`

Example Files: [ex\\_admm.c](#)

Also See: [read\\_adc\(\)](#), [setup\\_adc\(\)](#), [setup\\_adc\\_ports\(\)](#), [ADC Overview](#)

## set\_compare\_time( )

Syntax: `set_compare_time(x, ocr, [ocrs])`

Parameters: ***x*** is 1-8 and defines which output compare module to set time for  
***ocr*** is the compare time for the primary compare register.  
***ocrs*** is the optional compare time for the secondary register. Used for dual compare mode.

Returns: None

Function: This function sets the compare value for the output compare module. If the output compare module is to perform only a single compare than the ***ocrs*** register is not used. If the output compare module is using double compare to generate an output pulse, then ***ocr*** signifies the start of the pulse and ***ocrs*** defines the pulse termination time.

Availability: Only available on devices with output compare modules.

Requires: Nothing

Examples: `// Pin OC1 will be set when timer 2 is equal to 0xF000`  
`setup_timer2(TMR_INTERNAL | TIMER_DIV_BY_8);`  
`set_compare_time(1, 0xF000);`  
`setup_compare(1, COMPARE_SET_ON_MATCH | COMPARE_TIMER2);`

Example Files: None  
 Also See: [get\\_capture\(\)](#), [setup\\_compare\(\)](#), [ouput compare](#) / PWM Overview

## set\_motor\_pwm\_duty( )

Syntax: `set_motor_pwm_duty(pwm,group,time);`

Parameters: ***pwm***- Defines the pwm module used.

***group***- Output pair number 1,2 or 3.

***time***- The value set in the duty cycle register.

Returns: void

Function: Configures the motor control PWM unit duty.

Availability: Devices that have the motor control PWM unit.

Requires: None

Examples: `set_motor_pwm_duty(1,0,0x55); // Sets the PWM1 Unit a duty cycle value`

Example Files: None

Also See: [get\\_motor\\_pwm\\_count\(\)](#), [set\\_motor\\_pwm\\_event\(\)](#), [set\\_motor\\_unit\(\)](#), [setup\\_motor\\_pwm\(\)](#)

## set\_motor\_pwm\_event( )

Syntax: `set_motor_pwm_event(pwm,time);`

Parameters: ***pwm***- Defines the pwm module used.

***time***- The value in the special event comparator register used for scheduling other events.

Returns: void

Function: Configures the PWM event on the motor control unit.

Availability: Devices that have the motor control PWM unit.

Requires: None

Examples: `set_motor_pwm_event(pwm,time);`

Example Files: None

Also See: [get\\_motor\\_pwm\\_count\(\)](#), [setup\\_motor\\_pwm\(\)](#), [set\\_motor\\_unit\(\)](#), [set\\_motor\\_pwm\\_duty\(\)](#);

## set\_motor\_unit( )

Syntax: `set_motor_unit(pwm,unit,options, active_deadtime, inactive_deadtime);`

Parameters:

- pwm***- Defines the pwm module used
- Unit***- This will select Unit A or Unit B
- options***- The mode of the power PWM module. See the devices .h file for all options
- active\_deadtime***- Set the active deadtime for the unit
- inactive\_deadtime***- Set the inactive deadtime for the unit

Returns: void

Function: Configures the motor control PWM unit.

Availability: Devices that have the motor control PWM unit

Requires: None

Examples: `set_motor_unit(pwm,unit,MPWM_INDEPENDENT | MPWM_FORCE_L_1, active_deadtime, inactive_deadtime);`

Example Files: None

Also See: [get\\_motor\\_pwm\\_count\(\)](#), [set\\_motor\\_pwm\\_event\(\)](#), [set\\_motor\\_pwm\\_duty\(\)](#), [setup\\_motor\\_pwm\(\)](#)

## set\_pullup( )

Syntax: `set_Pullup(state [, pin])`

Parameters:

- Pins** are defined in the devices .h file. If no pin is provided in the function call, then all of the pins are set to the passed in state.
- State** is either true or false.

Returns: undefined

Function: Sets the pin's pull up state to the passed in state value. If no pin is included in the function call, then all valid pins are set to the passed in state.

## TEST PCD

Availability: All devices.

Requires: Pin constants are defined in the devices .h file.

Examples: 

```
set_pullup(true, PIN_B0);
//Sets pin B0's pull up state to true

set_pullup(false);
//Sets all pin's pull up state to false
```

Example Files: None

Also See: None

## set\_ticks( )

Syntax: `value = set_ticks();`

Parameters: value – a 8, 16, 32 or 64 bit integer, specifying the new value of the tick timer. (int8, int16, int32 or int64)

Returns: void

Function: Sets the new value of the tick timer. Size passed depends on the size of the tick timer.

Availability: All devices.

Requires: `#USE TIMER(options)`

Examples: 

```
#USE TIMER(TIMER=1,TICK=1ms,BITS=16,NOISR)

void main(void) {
    unsigned int16 value = 0x1000;

    set_ticks(value);
}
```

Example Files: None

Also See: [#USE TIMER](#), [get\\_ticks\(\)](#)



## set\_timerA( )

Syntax: `set_timerA(value);`

Parameters: An 8 bit integer. Specifying the new value of the timer. (int8)

Returns: undefined

Function: Sets the current value of the timer. All timers count up. When a timer reaches the maximum value it will flip over to 0 and continue counting (254, 255, 0, 1, 2, ...).

Availability: This function is only available on devices with Timer A hardware.

Requires: Nothing

Examples: 

```
// 20 mhz clock, no prescaler, set timer A
// to overflow in 35us

set_timerA(81); // 256-(.000035/(4/20000000))
```

Example Files: None

Also See: [get\\_timerA\(\)](#), [setup\\_timer\\_A\(\)](#), [TimerA Overview](#)

## set\_timerB( )

Syntax: `set_timerB(value);`

Parameters: An 8 bit integer. Specifying the new value of the timer. (int8)

Returns: undefined

Function: Sets the current value of the timer. All timers count up. When a timer reaches the maximum value it will flip over to 0 and continue counting (254, 255, 0, 1, 2, ...).

Availability: This function is only available on devices with Timer B hardware.

Requires: Nothing

Examples: 

```
// 20 mhz clock, no prescaler, set timer B
// to overflow in 35us

set_timerB(81); // 256-(.000035/(4/20000000))
```

Example Files: none

Also See: [get\\_timerB\(\)](#), [setup\\_timer\\_B\(\)](#), [TimerB Overview](#)

## set\_timerx( )

Syntax: `set_timerX(value)`

Parameters: A 16 bit integer, specifying the new value of the timer. (int16)

Returns: void

Function: Allows the user to set the value of the timer.

Availability: This function is available on all devices that have a valid timerX.

Requires: Nothing

Examples: 

```
if(EventOccured())
    set_timer2(0); //reset the timer.
```

Example Files: None

Also See: [Timer Overview](#), [setup\\_timerX\(\)](#), [get\\_timerXY\(\)](#), [set\\_timerX\(\)](#), [set\\_timerXY\(\)](#)

## set\_timerxy( )

Syntax: `set_timerXY(value)`

Parameters: A 32 bit integer, specifying the new value of the timer. (int32)

Returns: void

Function: Retrieves the 32 bit value of the timers X and Y, specified by XY(which may be 23, 45, 67 and 89)

Availability: This function is available on all devices that have a valid 32 bit enabled timers. Timers 2 & 3, 4 & 5, 6 & 7 and 8 & 9 may be used. The target device must have one of these timer sets. The target timers must be enabled as 32 bit.

Requires: Nothing

Examples: 

```
if(get_timer45() == THRESHOLD)
    set_timer(THRESHOLD + 0x1000); //skip those timer values
```

Example Files: None

Also See: [Timer Overview](#), [setup\\_timerX\(\)](#), [get\\_timerXY\(\)](#), [set\\_timerX\(\)](#), [set\\_timerXY\(\)](#)

## set\_tris\_x( )

Syntax:        set\_tris\_a (*value*)  
               set\_tris\_b (*value*)  
               set\_tris\_c (*value*)  
               set\_tris\_d (*value*)  
               set\_tris\_e (*value*)  
               set\_tris\_f (*value*)  
               set\_tris\_g (*value*)  
               set\_tris\_h (*value*)  
               set\_tris\_j (*value*)  
               set\_tris\_k (*value*)

Parameters:    **value** is an 16 bit int with each bit representing a bit of the I/O port.

Returns:        undefined

Function:       These functions allow the I/O port direction (TRI-State) registers to be set. This must be used with FAST\_IO and when I/O ports are accessed as memory such as when a # word directive is used to access an I/O port. Using the default standard I/O the built in functions set the I/O direction automatically.

Each bit in the value represents one pin. A 1 indicates the pin is input and a 0 indicates it is output.

Availability:   All devices (however not all devices have all I/O ports)

Requires:       Nothing

Examples:       

```
SET_TRIS_B( 0x0F );
// B7,B6,B5,B4 are outputs
// B15,B14,B13,B12,B11,B10,B9,B8, B3,B2,B1,B0 are inputs
```

Example         [lcd.c](#)

Files:

Also See:       [#USE FAST\\_IO](#), [#USE FIXED\\_IO](#), [#USE STANDARD\\_IO](#), [General Purpose I/O](#)

## set\_uart\_speed( )

Syntax:        set\_uart\_speed (*baud*, [*stream*, *clock*])

Parameters:    **baud** is a constant representing the number of bits per second.  
**stream** is an optional stream identifier.  
**clock** is an optional parameter to indicate what the current clock is if it is different from the #use delay value

Returns:        undefined

## TEST PCD

**Function:** Changes the baud rate of the built-in hardware RS232 serial port at run-time.

**Availability:** This function is only available on devices with a built in UART.

**Requires:** `#USE RS232`

**Examples:**

```
// Set baud rate based on setting
// of pins B0 and B1

switch( input_b() & 3 ) {
  case 0 : set_uart_speed(2400);  break;
  case 1 : set_uart_speed(4800);  break;
  case 2 : set_uart_speed(9600);  break;
  case 3 : set_uart_speed(19200); break;
}
```

**Example Files:** [loader.c](#)

**Also See:** [#USE RS232](#), [putc\(\)](#), [getc\(\)](#), [setup\\_uart\(\)](#), [RS232 I/O Overview](#)

## setjmp( )

**Syntax:** `result = setjmp (env)`

**Parameters:** **env**: The data object that will receive the current environment

**Returns:** If the return is from a direct invocation, this function returns 0.  
If the return is from a call to the longjmp function, the setjmp function returns a nonzero value and it's the same value passed to the longjmp function.

**Function:** Stores information on the current calling context in a data object of type jmp\_buf and which marks where you want control to pass on a corresponding longjmp call.

**Availability:** All devices

**Requires:** `#INCLUDE <setjmp.h>`

**Examples:** `result = setjmp(jmpbuf);`

**Example Files:** None

**Also See:** [longjmp\(\)](#)

## setup\_adc(mode) setup\_adc2(mode)

Syntax:        setup\_adc (*mode*);  
                setup\_adc2(*mode*);

Parameters:    *mode*- Analog to digital mode. The valid options vary depending on the device. See the devices .h file for all options. Some typical options include:

- ADC\_OFF
- ADC\_CLOCK\_INTERNAL
- ADC\_CLOCK\_DIV\_32
- ADC\_CLOCK\_INTERNAL – The ADC will use an internal clock
- ADC\_CLOCK\_DIV\_32 – The ADC will use the external clock scaled down by 32
- ADC\_TAD\_MUL\_16 – The ADC sample time will be 16 times the ADC conversion time

Returns:        undefined

Function:       Configures the ADC clock speed and the ADC sample time. The ADC converters have a maximum speed of operation, so ADC clock needs to be scaled accordingly. In addition, the sample time can be set by using a bitwise OR to concatenate the constant to the argument.

Availability:   Only the devices with built in analog to digital converter.

Requires:       Constants are defined in the devices .h file.

Examples:       

```
setup_adc_ports( ALL_ANALOG );
setup_adc(ADC_CLOCK_INTERNAL );
set_adc_channel( 0 );
value = read_adc();
setup_adc( ADC_OFF );
```

Example         [ex\\_admm.c](#)

Files:

Also See:       [setup\\_adc\\_ports\(\)](#), [set\\_adc\\_channel\(\)](#), [read\\_adc\(\)](#), [#DEVICE](#), [ADC Overview](#), see header file for device selected

## setup\_adc\_ports( ) setup\_adc\_ports2( )

Syntax:        setup\_adc\_ports (*value*)  
                setup\_adc\_ports (*ports*, [*reference*])  
                setup\_adc\_ports (*ports*, [*reference*])

Parameters:    *value* - a constant defined in the devices .h file

***ports*** - is a constant specifying the ADC pins to use

***reference*** - is an optional constant specifying the ADC reference to use

By default, the reference voltage are Vss and Vdd

**ports** is a constant specifying the ADC pins to use  
**reference** is an optional constant specifying the ADC reference voltages to use.  
 By default the reference voltages are Vss and Vdd.

Returns: undefined

Function: Sets up the ADC pins to be analog, digital, or a combination and the voltage reference to use when computing the ADC value. The allowed analog pin combinations vary depending on the chip and are defined by using the bitwise OR to concatenate selected pins together. Check the device include file for a complete list of available pins and reference voltage settings. The constants ALL\_ANALOG and NO\_ANALOGS are valid for all chips. Some other example pin definitions are:

- ANALOG\_RA3\_REF- All analog and RA3 is the reference
- RA0\_RA1\_RA3\_ANALOG- Just RA0, RA1 and RA3 are analog
- sAN1 | sAN2 – AN1 and AN2 are analog, remaining pins are digital
- sAN0 | sAN3 – AN0 and AN3 are analog, remaining pins are digital

Availability: Only available on devices with built in analog to digital converters

Requires: Constants are defined in the devices .h file.

Examples: 

```
// Set all ADC pins to analog mode
setup_adc_ports(ALL_ANALOG);

// Pins AN0, AN1 and AN3 are analog and all other pins
// are digital.
setup_adc_ports(sAN0 | sAN1 | sAN3);

// Pins AN0 and AN1 are analog. The VrefL pin
// and Vdd are used for voltage references
setup_adc_ports(sAN0 | sAN1, VREF_VDD);
```

Example Files: [ex\\_admm.c](#)

Also See: [setup\\_adc\(\)](#), [read\\_adc\(\)](#), [set\\_adc\\_channel\(\)](#), [ADC Overview](#)

## setup\_capture( )

Syntax: setup\_capture(**x**, **mode**)

Parameters: **x** is 1-8 and defines which input capture module is being configured  
**mode** is defined by the constants in the devices .h file

Returns: None

Function: This function specifies how the input capture module is going to function based on the value of mode. The device specific options are listed in the device .h file.

Availability: Only available on devices with Input Capture modules

Requires: None

Examples: 

```
setup_timer3(TMR_INTERNAL | TMR_DIV_BY_8);
setup_capture(2, CAPTURE_FE | CAPTURE_TIMER3);
```

```

while(TRUE) {
    timerValue = get_capture(2, TRUE);
    printf("Capture 2 occurred at: %LU", timerValue);
}

```

Example Files: None

Also See: [get\\_capture\(\)](#), [setup\\_compare\(\)](#), [Input Capture Overview](#)

## setup\_comparator( )

Syntax: `setup_comparator (mode)`

Parameters: **mode** is a bit-field comprised of the following constants:

```

NC_NC_NC_NC
A4_A5_NC_NC
A4_VR_NC_NC
A5_VR_NC_NC
NC_NC_A2_A3
NC_NC_A2_VR
NC_NC_A3_VR
A4_A5_A2_A3
A4_VR_A2_VR
A5_VR_A3_VR
C1_INVERT
C2_INVERT
C1_OUTPUT
C2_OUTPUT

```

Returns: void

Function: Configures the voltage comparator.

The voltage comparator allows you to compare two voltages and find the greater of them. The configuration constants for this function specify the sources for the comparator in the order C1- C1+, C2-, C2+. The constants may be or'ed together if the NC's do not overlap; A4\_A5\_NC\_NC | NC\_NC\_A3\_VR is valid, however, A4\_A5\_NC\_NC | A4\_VR\_NC\_NC may produce unexpected results. The results of the comparator module are stored in C1OUT and C2OUT, respectively. Cx\_INVERT will invert the results of the comparator and Cx\_OUTPUT will output the results to the comparator output pin.

Availability: Some devices, consult your target datasheet.

Requires Constants are defined in the devices .h file.

Examples: `setup_comparator(A4_A5_NC_NC); //use C1, not C2`

## setup\_compare( )

Syntax: `setup_compare(x, mode)`

Parameters: **mode** is defined by the constants in the devices .h file  
**x** is 1-8 and specifies which OC pin to use.

## TEST PCD

|                |   |
|----------------|---|
| Returns:       | None  |
| Function:      | This function specifies how the output compare module is going to function based on the value of <i>mode</i> . The device specific options are listed in the device .h file.                          |
| Availability:  | Only available on devices with output compare modules.  |
| Requires:      | None  |
| Examples:      | <pre>// Pin OC1 will be set when timer 2 is equal to 0xF000 setup_timer2(TMR_INTERNAL   TIMER_DIV_BY_16); set_compare_time(1, 0xF000); setup_compare(1, COMPARE_SET_ON_MATCH   COMPARE_TIMER2);</pre> |
| Example Files: | None  |
| Also See:      | <a href="#">set_compare_time()</a> , <a href="#">set_pwm_duty()</a> , <a href="#">setup_capture()</a> , <a href="#">Output Compare / PWM Overview</a>   |

## setup\_crc(mode)

Syntax: `setup_crc(polynomial terms)`

Parameters: ***polynomial*** - This will setup the actual polynomial in the CRC engine. The power of each term is passed separated by a comma. 0 is allowed, but ignored. The following define is added to the device's header file (32-bit CRC Moduel Only), to enable little-endian shift direction:

- CRC\_LITTLE\_ENDIAN

Returns: undefined

Function: Configures the CRC engine register with the polynomial

Availability: Only the devices with built in CRC module

Requires: Nothing

Examples: 

```
setup_crc (12, 5);
// CRC Polynomial is X12 + X5 + 1

setup_crc(16, 15, 3, 1);
// CRC Polynomial is X16 + X15 + X3 + X1 + 1
```

Example Files: [ex.c](#)

Also See: [crc\\_init\(\)](#); [crc\\_calc\(\)](#); [crc\\_calc8\(\)](#)



## setup\_dac( )

Syntax:            setup\_dac(mode);  
                  setup\_dac(mode, divisor);

Parameters:       **mode**- The valid options vary depending on the device. See the devices .h file for all options. Some typical options include:

- DAC\_OUTPUT

**divisor**- Divides the provided clock

Returns:           undefined

Function:          Configures the DAC including reference voltage. Configures the DAC including channel output and clock speed.

Availability:      Only the devices with built in digital to analog converter.

Requires:          Constants are defined in the devices .h file.

Examples:          

```
setup_dac(DAC_VDD | DAC_OUTPUT);
dac_write(value);
setup_dac(DAC_RIGHT_ON, 5);
```

Example Files:     None

Also See:          [dac\\_write\(\)](#), [DAC Overview](#), See header file for device selected

## setup\_dci( )

Syntax:            setup\_dci(configuration, data size, rx config, tx config, sample rate);

Parameters:        *configuration* - Specifies the configuration the Data Converter Interface should be initialized into, including the mode of transmission and bus properties. The following constants may be combined ( OR'd) for this parameter:

- CODEC\_MULTICHANNEL
- CODEC\_I2S· CODEC\_AC16
- CODEC\_AC20· JUSTIFY\_DATA· DCI\_MASTER
- DCI\_SLAVE· TRISTATE\_BUS· MULTI\_DEVICE\_BUS
- SAMPLE\_FALLING\_EDGE· SAMPLE\_RISING\_EDGE
- DCI\_CLOCK\_INPUT· DCI\_CLOCK\_OUTPUT

*data size* – Specifies the size of frames and words in the transmission:

- DCI\_xBIT\_WORD: x may be 4 through 16
- DCI\_xWORD\_FRAME: x may be 1 through 16
- DCI\_xWORD\_INTERRUPT: x may be 1 through 4

*rx config*- Specifies which words of a given frame the DCI module will receive (commonly used for a multi-channel, shared bus situation)

- RECEIVE\_SLOTx: x May be 0 through 15
- RECEIVE\_ALL· RECEIVE\_NONE

*tx config*- Specifies which words of a given frame the DCI module will transmit on.

- TRANSMIT\_SLOTx: x May be 0 through 15
- TRANSMIT\_ALL
- TRANSMIT\_NONE

*sample rate*-The desired number of frames per second that the DCI module should produce. Use a numeric value for this parameter. Keep in mind that not all rates are achievable with a given clock. Consult the device datasheet for more information on selecting an adequate clock.

Returns: undefined

Function: Configures the DCI module

Availability: Only on devices with the DCI peripheral

Requires: Constants are defined in the devices .h file.

Examples: 

```
dci_initialize((I2S_MODE | DCI_MASTER | DCI_CLOCK_OUTPUT |
                SAMPLE_RISING_EDGE | UNDERFLOW_LAST |
                MULTI_DEVICE_BUS),
                DCI_1WORD_FRAME | DCI_16BIT_WORD |
                DCI_2WORD_INTERRUPT,
                RECEIVE_SLOT0 | RECEIVE_SLOT1,
                TRANSMIT_SLOT0 | TRANSMIT_SLOT1,
                44100);
```

Example Files: None

Also See: [DCI Overview](#), [dci start\(\)](#), [dci write\(\)](#), [dci read\(\)](#), [dci transmit ready\(\)](#), [dci data received\(\)](#)

## setup\_dma( )

Syntax: `setup_dma(channel, peripheral, mode);`

|                |   |
|----------------|---|
| Parameters:    | Channel- The channel used in the DMA transfer<br>peripheral - The peripheral that the DMA wishes to talk to.<br>mode- This will specify the mode used in the DMA transfer |
| Returns:       | void  |
| Function:      | Configures the DMA module to copy data from the specified peripheral to RAM allocated for the DMA channel.  |
| Availability:  | Devices that have the DMA module.   |
| Requires       | Nothing   |
| Examples:      | <pre>setup_dma(2, DMA_IN_SPI1, DMA_BYTE); // This will setup the DMA channel 1 to talk to SPI1 input buffer.</pre>  |
| Example Files: | None  |
| Also See       | <a href="#">dma_start()</a> , <a href="#">dma_status()</a>  |

## setup\_high\_speed\_adc( )

Syntax: `setup_high_speed_adc (mode);`

|                |   |
|----------------|---|
| Parameters:    | mode – Analog to digital mode. The valid options vary depending on the device. See the devices .h file for all options. Some typical options include: <ul style="list-style-type: none"> <li>▪ ADC_OFF</li> <li>▪ ADC_CLOCK_DIV_1</li> <li>▪ ADC_HALT_IDLE – The ADC will not run when PIC is idle.</li> </ul>                                  |
| Returns:       | Undefined   |
| Function:      | Configures the High-Speed ADC clock speed and other High-Speed ADC options including, when the ADC interrupts occurs, the output result format, the conversion order, whether the ADC pair is sampled sequentially or simultaneously, and whether the dedicated sample and hold is continuously sampled or samples when a trigger event occurs. |
| Availability:  | Only on devices with a built-in high-speed analog to digital converter.   |
| Requires:      | Constants are define in the device .h file.   |
| Examples:      | <pre>setup_high_speed_adc_pair(0, INDIVIDUAL_SOFTWARE_TRIGGER); setup_high_speed_adc(ADC_CLOCK_DIV_4); read_high_speed_adc(0, START_AND_READ, result); setup_high_speed_adc(ADC_OFF);</pre>   |
| Example Files: | None  |
| Also See:      | <a href="#">setup_high_speed_adc_pair()</a> , <a href="#">read_high_speed_adc()</a> , <a href="#">high_speed_adc_done()</a>   |

## setup\_high\_speed\_adc\_pair( )

Syntax: `setup_high_speed_adc_pair(pair, mode);`

**Parameters:** **pair** – The High-Speed ADC pair number to setup, valid values are 0 to total number of ADC pairs. 0 sets up ADC pair AN0 and AN1, 1 sets up ADC pair AN2 and AN3, etc.

**mode** – ADC pair mode. The valid options vary depending on the device. See the devices .h file for all options. Some typical options include:

- `INDIVIDUAL_SOFTWARE_TRIGGER`
- `GLOBAL_SOFTWARE_TRIGGER`
- `PWM_PRIMARY_SE_TRIGGER`
- `PWM_GEN1_PRIMARY_TRIGGER`
- `PWM_GEN2_PRIMARY_TRIGGER`

**Returns:** Undefined

**Function:** Sets up the analog pins and trigger source for the specified ADC pair. Also sets up whether ADC conversion for the specified pair triggers the common ADC interrupt.

If zero is passed for the second parameter the corresponding analog pins will be set to digital pins.

**Availability:** Only on devices with a built-in high-speed analog to digital converter.

**Requires:** Constants are define in the device .h file.

**Examples:**

```
setup_high_speed_adc_pair(0, INDIVIDUAL_SOFTWARE_TRIGGER);
setup_high_speed_adc_pair(1, GLOBAL_SOFTWARE_TRIGGER);
setup_high_speed_adc_pair(2, 0) - sets AN4 and AN5 as
digital pins.
```

**Example Files:** None

**Also See:** [setup\\_high\\_speed\\_adc\(\)](#), [read\\_high\\_speed\\_adc\(\)](#), [high\\_speed\\_adc\\_done\(\)](#)

## setup\_low\_volt\_detect( )

Syntax: `setup_low_volt_detect(mode)`

Parameters: `mode` may be one of the constants defined in the devices .h file. LVD\_LVDIN, LVD\_45, LVD\_42, LVD\_40, LVD\_38, LVD\_36, LVD\_35, LVD\_33, LVD\_30, LVD\_28, LVD\_27, LVD\_25, LVD\_23, LVD\_21, LVD\_19  
One of the following may be or'ed(via |) with the above if high voltage detect is also available in the device  
LVD\_TRIGGER\_BELOW, LVD\_TRIGGER\_ABOVE

Returns: undefined

Function: This function controls the high/low voltage detect module in the device. The mode constants specifies the voltage trip point and a direction of change from that point (available only if high voltage detect module is included in the device). If the device experiences a change past the trip point in the specified direction the interrupt flag is set and if the interrupt is enabled the execution branches to the interrupt service routine.

Availability: This function is only available with devices that have the high/low voltage detect module.

Requires Constants are defined in the devices.h file.

Examples: `setup_low_volt_detect( LVD_TRIGGER_BELOW | LVD_36 );`

This would trigger the interrupt when the voltage is below 3.6 volts

## setup\_motor\_pwm( )

Syntax: `setup_motor_pwm(pwm,options,timebase);`  
`setup_motor_pwm(pwm,options,prescale,postscale,timebase);`

Parameters: ***Pwm***- Defines the pwm module used.

***Options***- The mode of the power PWM module. See the devices .h file for all options

***timebase***- This parameter sets up the PWM time base pre-scale and post-scale.

***prescale***- This will select the PWM timebase prescale setting

***postscale***- This will select the PWM timebase postscale setting

Returns: void

Function: Configures the motor control PWM module

Availability: Devices that have the motor control PWM unit.

|                |   |
|----------------|---|
| Requires:      | None  |
| Examples:      | <code>setup_motor_pwm(1,MPWM_FREE_RUN   MPWM_SYNC_OVERRIDES, timebase);</code>  |
| Example Files: | None  |
| Also See:      | <a href="#">get motor pwm count()</a> , <a href="#">set motor pwm event()</a> , <a href="#">set motor unit()</a> , <a href="#">set motor pwm duty()</a> ; |

## setup\_oscillator( )

|                |  |
|----------------|--|
| Syntax:        | <code>setup_oscillator(<i>mode</i>, <i>target</i> [<i>,source</i>] [<i>,divide</i>])</code>  |
| Parameters:    | <p>Mode is one of:</p> <ul style="list-style-type: none"> <li>• OSC_INTERNAL</li> <li>• OSC_CRYSTAL</li> <li>• OSC_CLOCK</li> <li>• OSC_RC</li> <li>• OSC_SECONDARY</li> </ul> <p>Target is the target frequency to run the device it.</p> <p>Source is optional. It specifies the external crystal/oscillator frequency. If omitted the value from the last #USE_DELAY is used. If mode is OSC_INTERNAL, source is an optional tune value for the internal oscillator for PICs that support it. If omitted a tune value of zero will be used.</p> <p>Divide in optional. For PICs that support it, it specifies the divide ration for the Display Module Interface Clock. A number from 0 to 64 divides the clock from 1 to 17 increasing in increments of 0.25, a number from 64 to 96 divides the clock from 17 to 33 increasing in increments of 0.5, and a number from 96 to 127 divides the clock from 33 to 64 increasing in increments of 1. If omitted zero will be used for divide by 1.</p> |
| Returns:       | None   |
| Function:      | Configures the oscillator with preset internal and external source configurations. If the device fuses are set and #use_delay() is specified, the compiler will configure the oscillator. Use this function for explicit configuration or programming dynamic clock switches. Please consult your target data sheets for valid configurations, especially when using the PLL multiplier, as many frequency range restrictions are specified.   |
| Availability:  | This function is available on all devices.   |
| Requires:      | The configuration constants are defined in the device's header file.   |
| Examples:      | <code>setup_oscillator( OSC_CRYSTAL, 4000000, 16000000);</code><br><code>setup_oscillator( OSC_INTERNAL, 29480000);</code>   |
| Example Files: | None   |
| Also See:      | <a href="#">setup_wdt()</a> , Internal Oscillator Overview   |

## setup\_pmp(option, address\_mask)

Syntax: `setup_pmp(options,address_mask);`

Parameters: **options**- The mode of the Parallel Master Port that allows to set the Master Port mode, read-write strobe options and other functionality of the PMPort module. See the device's .h file for all options. Some typical options include:

- PAR\_PSP\_AUTO\_INC
- PAR\_CONTINUE\_IN\_IDLE
- PAR\_INTR\_ON\_RW //Interrupt on read write
- PAR\_INC\_ADDR //Increment address by 1 every read/write cycle
- PAR\_MASTER\_MODE\_1 //Master Mode 1
- PAR\_WAITE4 //4 Tcy Wait for data hold after strobe

**address\_mask**- this allows the user to setup the address enable register with a 16-bit value. This value determines which address lines are active from the available 16 address lines PMA0:PMA15.

Returns: Undefined.

Function: Configures various options in the PMP module. The options are present in the device's .h file and they are used to setup the module. The PMP module is highly configurable and this function allows users to setup configurations like the Slave module, Interrupt options, address increment/decrement options, Address enable bits, and various strobe and delay options.

Availability: Only the devices with a built-in Parallel Master Port module.

Requires: Constants are defined in the device's .h file.

Examples: 

```
setup_psp(PAR_ENABLE| //Sets up Master mode with
address
PAR_MASTER_MODE_1|PAR_ //lines PMA0:PMA7
STOP_IN_IDLE,0x00FF);
```

Example Files: None

Also See: [setup\\_pmp\(\)](#), [pmp\\_address\(\)](#), [pmp\\_read\(\)](#), [psp\\_read\(\)](#), [psp\\_write\(\)](#), [pmp\\_write\(\)](#), [psp\\_output\\_full\(\)](#), [psp\\_input\\_full\(\)](#), [psp\\_overflow\(\)](#), [pmp\\_output\\_full\(\)](#), [pmp\\_input\\_full\(\)](#), [pmp\\_overflow\(\)](#)  
See header file for device selected

## setup\_power\_pwm\_pins( )

Syntax: setup\_power\_pwm\_pins(module0,module1,module2,module3)

Parameters: For each module (two pins) specify:  
PWM\_OFF, PWM\_ODD\_ON, PWM\_BOTH\_ON,  
PWM\_COMPLEMENTARY

Returns: undefined

Function: Configures the pins of the Pulse Width Modulation (PWM) device.

Availability: All devices equipped with a motor control PWM.

Requires: None

Examples: 

```
setup_power_pwm_pins(PWM_OFF, PWM_OFF, PWM_OFF,
                    PWM_OFF);
setup_power_pwm_pins(PWM_COMPLEMENTARY,
                    PWM_COMPLEMENTARY, PWM_OFF, PWM_OFF);
```

Example Files: None

Also See: setup\_power\_pwm(), set\_power\_pwm\_override(),set\_power\_pwmX\_duty()

## setup\_psp(option,addresses\_mask)

Syntax: setup\_psp (*options,address\_mask*);  
setup\_psp(*options*);

Parameters: **Option**- The mode of the Parallel slave port. This allows to set the slave port mode, read-write strobe options and other functionality of the PMP/EPMP module. See the devices .h file for all options. Some typical options include:

- PAR\_PSP\_AUTO\_INC
- PAR\_CONTINUE\_IN\_IDLE
- PAR\_INTR\_ON\_RW //Interrupt on read write
- PAR\_INC\_ADDR //Increment address by 1 every read/write cycle
- PAR\_WAITE4 //4 Tcy Wait for data hold after strobe

**address\_mask**- This allows the user to setup the address enable register with a 16 bit or 32 bit (EPMP) value. This value determines which address lines are active from the available 16 address lines PMA0: PMA15 or 32 address lines PMA0:PMA31 (EPMP only).

Returns: Undefined.



**Function:** Configures various options in the PMP/EPMP module. The options are present in the device.h file and they are used to setup the module. The PMP/EPMP module is highly configurable and this function allows users to setup configurations like the Slave mode, Interrupt options, address increment/decrement options, Address enable bits and various strobe and delay options.

**Availability:** Only the devices with a built in Parallel Port module or Enhanced Parallel Master Port module.

**Requires:** Constants are defined in the devices .h file.

**Examples:**

```
setup_psp(PAR_PSP_AUTO_INC|          //Sets up legacy slave mode
with
PAR_STOP_IN_IDLE,0x00FF );          //read and write buffers
auto increment.
```

**Example Files:** None

**Also See:** [setup\\_pmp\(\)](#) , [pmp\\_address\(\)](#) , [pmp\\_read\(\)](#) , [psp\\_read\(\)](#) , [psp\\_write\(\)](#) , [pmp\\_write\(\)](#) , [psp\\_output\\_full\(\)](#) , [psp\\_input\\_full\(\)](#) , [psp\\_overflow\(\)](#) , [pmp\\_output\\_full\(\)](#) , [pmp\\_input\\_full\(\)](#) , [pmp\\_overflow\(\)](#), see header file for device selected.

## setup\_qei( )

**Syntax:** setup\_qei( [*unit*],*options*, *filter*, *maxcount* );

**Parameters:** **Options-** The mode of the QEI module. See the devices .h file for all options

Some common options are:

- QEI\_MODE\_X2
- QEI\_TIMER\_GATED
- QEI\_TIMER\_DIV\_BY\_1

**filter** - This parameter is optional and the user can specify the digital filter clock divisor.

**maxcount** - This will specify the value at which to reset the position counter.

**unit** - Optional unit number, defaults to 1.

**Returns:** void

**Function:** Configures the Quadrature Encoder Interface. Various settings like modes, direction can be setup.

**Availability:** Devices that have the QEI module.

## TEST PCD

Requires: Nothing.

Examples: 

```
setup_gei(QEI_MODE_X2|QEI_TIMER_INTERNAL,QEI_FILTER_DIV_2,
QEI_FORWARD);
```

Example Files: None

Also See: [gei\\_set\\_count\(\)](#) , [gei\\_get\\_count\(\)](#) , [gei\\_status\(\)](#)

## setup\_rtc( )

Syntax: `setup_rtc(options, calibration);`

Parameters: **Options**- The mode of the RTCC module. See the devices .h file for all options

**Calibration**- This parameter is optional and the user can specify an 8 bit value that will get written to the calibration configuration register.

Returns: void

Function: Configures the Real Time Clock and Calendar module. The module requires an external 32.768 kHz Clock Crystal for operation.

Availability: Devices that have the RTCC module.

Requires: Nothing.

Examples: 

```
setup_rtc(RTC_ENABLE | RTC_OUTPUT_SECONDS, 0x00);
// Enable RTCC module with seconds clock and no calibration
```

Example Files: None

Also See: [rtc\\_read\(\)](#), [rtc\\_alarm\\_read\(\)](#), [rtc\\_alarm\\_write\(\)](#), [setup\\_rtc\\_alarm\(\)](#), [rtc\\_write\(\)](#), [setup\\_rtc\(\)](#)

## setup\_rtc\_alarm( )

Syntax: `setup_rtc_alarm(options, mask, repeat);`

Parameters: **options**- The mode of the RTCC module. See the devices .h file for all options

**mask**- This parameter is optional and the user can specify the alarm mask bits

for the alarm configuration.

**repeat**- This will specify the number of times the alarm will repeat. It can have a max value of 255.

Returns: void

Function: Configures the alarm of the RTCC module. The mask and repeat parameters are optional, and allow the use to configure the alarm settings on the RTCC module.

Availability: Devices that have the RTCC module.

Requires: Nothing.

Examples: `setup_rtc_alarm(RTC_ALARM_ENABLE, RTC_ALARM_HOUR, 3);`

Example Files: None

Also See: [rtc\\_read\(\)](#), [rtc\\_alarm\\_read\(\)](#), [rtc\\_alarm\\_write\(\)](#), [setup\\_rtc\\_alarm\(\)](#), [rtc\\_write\(\)](#), [setup\\_rtc\(\)](#)

## setup\_spi( ) setup\_spi2( )

Syntax: `setup_spi (mode)`  
`setup_spi2 (mode)`

Parameters: **mode** may be:

- SPI\_MASTER, SPI\_SLAVE, SPI\_SS\_DISABLED
- SPI\_L\_TO\_H, SPI\_H\_TO\_L
- SPI\_CLK\_DIV\_4, SPI\_CLK\_DIV\_16,
- SPI\_CLK\_DIV\_64, SPI\_CLK\_T2
- SPI\_SAMPLE\_AT\_END, SPI\_XMIT\_L\_TO\_H
- SPI\_MODE\_16B, SPI\_XMIT\_L\_TO\_H
- Constants from each group may be or'ed together with |.

Returns: undefined

Function: Configures the hardware SPI™ module.

- SPI\_MASTER will configure the module as the bus master
- SPI\_SLAVE will configure the module as a slave on the SPI™ bus
- SPI\_SS\_DISABLED will turn off the slave select pin so the slave module receives any transmission on the bus.
- SPI\_x\_to\_y will specify the clock edge on which to sample and transmit data
- SPI\_CLK\_DIV\_x will specify the divisor used to create the SCK clock from system clock.

## TEST PCD

|                |  |
|----------------|--|
| Availability:  | This function is only available on devices with SPI hardware.  |
| Requires:      | Constants are defined in the devices .h file.  |
| Examples:      | <code>setup_spi(SPI_MASTER   SPI_L_TO_H   SPI_DIV_BY_16);</code>   |
| Example Files: | <a href="#">ex_spi.c</a>   |
| Also See:      | <a href="#">spi_write()</a> , <a href="#">spi_read()</a> , <a href="#">spi_data_is_in()</a> , <a href="#">SPI Overview</a> |

## setup\_timerx( )

Syntax: `setup_timerX(mode)`  
`setup_timerX(mode,period)`

Parameters: Mode is a bit-field comprised of the following configuration constants:

- TMR\_DISABLED: Disables the timer operation.
- TMR\_INTERNAL: Enables the timer operation using the system clock. Without divisions, the timer will increment on every instruction cycle. On PCD, this is half the oscillator frequency.
- TMR\_EXTERNAL: Uses a clock source that is connected to the SOSCI/SOSCO pins
- T1\_EXTERNAL\_SYNC: Uses a clock source that is connected to the SOSCI/SOSCO pins. The timer will increment on the rising edge of the external clock which is synchronized to the internal clock phases. This mode is available only for Timer1.
- T1\_EXTERNAL\_RTC: Uses a low power clock source connected to the SOSCI/SOSCO pins; suitable for use as a real time clock. If this mode is used, the low power oscillator will be enabled by the setup\_timer function. This mode is available only for Timer1.
- TMR\_DIV\_BY\_X: X is the number of input clock cycles to pass before the timer is incremented. X may be 1, 8, 64 or 256.
- TMR\_32\_BIT: This configuration concatenates the timers into 32 bit mode. This constant should be used with timers 2, 4, 6 and 8 only.
- Period is an optional 16 bit integer parameter that specifies the timer period. The default value is 0xFFFF.

Returns: void

Function: Sets up the timer specified by X (May be 1 – 9). X must be a valid timer on the target device.

Availability: This function is available on all devices that have a valid timer X. Use getenv or refer to the target datasheet to determine which timers are valid.

|                |  |
|----------------|--|
| Requires:      | Configuration constants are defined in the device's header file.   |
| Examples:      | <pre>/* setup a timer that increments every 64th instruction cycle with an overflow period of 0xA010 */ setup_timer2(TMR_INTERNAL   TMR_DIV_BY_64, 0xA010);  /* Setup another timer as a 32-bit hybrid with a period of 0xFFFFFFFF and a interrupt that will be fired when that timer overflows*/ setup_timer4(TMR_32_BIT); //use get_timer45() to get the timer value enable_interrupts(int_timer5); //use the odd number timer for the interrupt</pre> |
| Example Files: | None   |
| Also See:      | <a href="#">Timer Overview</a> , <a href="#">setup_timerX()</a> , <a href="#">get_timerXY()</a> , <a href="#">set_timerX()</a> , <a href="#">set_timerXY()</a>   |

## setup\_timer\_A( )

|                |   |
|----------------|---|
| Syntax:        | setup_timer_A ( <b>mode</b> );  |
| Parameters:    | <p><b>mode</b> values may be:</p> <ul style="list-style-type: none"> <li>· TA_OFF, TA_INTERNAL, TA_EXT_H_TO_L, TA_EXT_L_TO_H</li> <li>· TA_DIV_1, TA_DIV_2, TA_DIV_4, TA_DIV_8, TA_DIV_16, TA_DIV_32, TA_DIV_64, TA_DIV_128, TA_DIV_256</li> <li>· constants from different groups may be or'ed together with  .</li> </ul> |
| Returns:       | undefined   |
| Function:      | sets up Timer A.  |
| Availability:  | This function is only available on devices with Timer A hardware.   |
| Requires:      | Constants are defined in the device's .h file.  |
| Examples:      | <pre>setup_timer_A(TA_OFF); setup_timer_A(TA_INTERNAL   TA_DIV_256); setup_timer_A(TA_EXT_L_TO_H   TA_DIV_1);</pre>   |
| Example Files: | none  |
| Also See:      | <a href="#">get_timerA()</a> , <a href="#">set_timerA()</a> , <a href="#">TimerA Overview</a>   |

## setup\_timer\_B( )

Syntax: `setup_timer_B (mode);`

Parameters: **mode** values may be:

- TB\_OFF, TB\_INTERNAL, TB\_EXT\_H\_TO\_L, TB\_EXT\_L\_TO\_H
- TB\_DIV\_1, TB\_DIV\_2, TB\_DIV\_4, TB\_DIV\_8, TB\_DIV\_16, TB\_DIV\_32, TB\_DIV\_64, TB\_DIV\_128, TB\_DIV\_256
- constants from different groups may be or'ed together with |.

Returns: undefined

Function: sets up Timer B

Availability: This function is only available on devices with Timer B hardware.

Requires: Constants are defined in device's .h file.

Examples:

```
setup_timer_B(TB_OFF);
setup_timer_B(TB_INTERNAL | TB_DIV_256);
setup_timer_B(TA_EXT_L_TO_H | TB_DIV_1);
```

Example Files: none

Also See: [get\\_timerB\( \)](#), [set\\_timerB\( \)](#), [TimerB Overview](#)

## setup\_uart( )

Syntax: `setup_uart(baud, stream)`  
`setup_uart(baud)`  
`setup_uart(baud, stream, clock)`

Parameters: **baud** is a constant representing the number of bits per second. A one or zero may also be passed to control the on/off status. **Stream** is an optional stream identifier.

*Chips with the advanced UART may also use the following constants:*

UART\_ADDRESS UART only accepts data with 9th bit=1

UART\_DATA UART accepts all data

*Chips with the EUART H/W may use the following constants:*

UART\_AUTODETECT Waits for 0x55 character and sets the UART baud rate to match.

UART\_AUTODETECT\_NOWAIT Same as above function, except returns before

0x55 is received. KBHIT() will be true when the match is made. A call to GETC() will clear the character.  
 UART\_WAKEUP\_ON\_RDA Wakes PIC up out of sleep when RCV goes from high to low

**clock** - If specified this is the clock rate this function should assume. The default comes from the #USE\_DELAY.

Returns: undefined

Function: Very similar to SET\_UART\_SPEED. If 1 is passed as a parameter, the UART is turned on, and if 0 is passed, UART is turned off. If a BAUD rate is passed to it, the UART is also turned on, if not already on.

Availability: This function is only available on devices with a built in UART.

Requires: #USE\_RS232

Examples: 

```
setup_uart(9600);
setup_uart(9600, rsOut);
```

Example Files: None

Also See: [#USE\\_RS232](#), [putc\(\)](#), [getc\(\)](#), [RS232 I/O Overview](#)

## setup\_vref( )

Syntax: setup\_vref (*mode*)

Parameters: **mode** is a bit-field comprised of the following constants:

- VREF\_DISABLED
- VREF\_LOW ( Vdd \* value / 24)
- VREF\_HIGH ( Vdd \* value / 32 + Vdd/4 )
- VREF\_ANALOG

Returns: undefined

Function: Configures the voltage reference circuit used by the voltage comparator.

The voltage reference circuit allows you to specify a reference voltage that the comparator module may use. You may use the Vdd and Vss voltages as your reference or you may specify VREF\_ANALOG to use supplied Vdd and Vss. Voltages may also be tuned to specific values in steps, 0 through 15. That value must be or'ed to the configuration constants.

**Availability:** Some devices, consult your target datasheet.

**Requires:** Constants are defined in the devices .h file.

**Examples:**

```
/* Use the 15th step on the course setting */
setup_vref(VREF_LOW | 14);
```

**Example Files:** None

## setup\_wdt( )

**Syntax:** setup\_wdt (*mode*)

**Parameters:** Mode is a bit-field comprised of the following constants:

- WDT\_ON
- WDT\_OFF

**Returns:** void

**Function:** Configures the watchdog timer. The watchdog timer is used to monitor the software. If the software does not reset the watchdog timer before it overflows, the device is reset, preventing the device from hanging until a manual reset is initiated. The watchdog timer is derived from the slow internal timer.

**Availability:** All devices

**Requires:** #FUSES, Constants are defined in the devices .h file.

**Examples:**

```
setup_wdt(WDT_ON);
```

**Example Files:** [ex\\_wdt.c](#)

**Also See:** [Internal Oscillator Overview](#)

## shift\_left( )

**Syntax:** shift\_left (*address, bytes, value*)

**Parameters:** *address* is a pointer to memory, *bytes* is a count of the number of bytes to work with, *value* is a 0 to 1 to be shifted in.

**Returns:** 0 or 1 for the bit shifted out

**Function:** Shifts a bit into an array or structure. The address may be an array identifier or an address to a structure (such as &data). Bit 0 of the lowest byte in RAM is treated as the LSB.

**Availability:** All devices



**Requires:** Nothing

**Examples:**

```
byte buffer[3];
for(i=0; i<=24; ++i){
    // Wait for clock high
    while (!input(PIN_A2));
    shift_left(buffer,3,input(PIN_A3));
    // Wait for clock low
    while (input(PIN_A2));
}
// reads 24 bits from pin A3,each bit is read
// on a low to high on pin A2
```

**Example Files:** [ex\\_extee.c](#), [9356.c](#)

**Files:**

**Also See:** [shift\\_right\(\)](#), [rotate\\_right\(\)](#), [rotate\\_left\(\)](#)

## shift\_right( )

**Syntax:** shift\_right (*address, bytes, value*)

**Parameters:** *address* is a pointer to memory, *bytes* is a count of the number of bytes to work with, *value* is a 0 to 1 to be shifted in.

**Returns:** 0 or 1 for the bit shifted out

**Function:** Shifts a bit into an array or structure. The address may be an array identifier or an address to a structure (such as &data). Bit 0 of the lowest byte in RAM is treated as the LSB.

**Availability:** All devices

**Requires:** Nothing

**Examples:**

```
// reads 16 bits from pin A1, each bit is read
// on a low to high on pin A2
struct {
    byte time;
    byte command : 4;
    byte source : 4;} msg;

for(i=0; i<=16; ++i) {
    while(!input(PIN_A2));
    shift_right(&msg,3,input(PIN_A1));
    while (input(PIN_A2)) ;}

// This shifts 8 bits out PIN_A0, LSB first.
for(i=0;i<8;++i)
    output_bit(PIN_A0,shift_right(&data,1,0));
```

**Example Files:** [ex\\_extee.c](#), [9356.c](#)

**Files:**

**Also See:** [shift\\_left\(\)](#), [rotate\\_right\(\)](#), [rotate\\_left\(\)](#)

## sin( ) cos( ) tan( ) asin( ) acos() atan() sinh() cosh() tanh() atan2()

Syntax:        `val = sin (rad)`  
                  `val = cos (rad)`  
                  `val = tan (rad)`  
                  `rad = asin (val)`  
                  `rad1 = acos (val)`  
                  `rad = atan (val)`  
                  `rad2=atan2(val, val)`  
                  `result=sinh(value)`  
                  `result=cosh(value)`  
                  `result=tanh(value)`

Parameters:    **rad** is any float type representing an angle in Radians -2pi to 2pi.  
                  **val** is any float type with the range -1.0 to 1.0.  
                  **Value** is any float type

Returns:        `rad` is a float with a precision equal to **val** representing an angle in Radians -pi/2 to pi/2

`val` is a float with a precision equal to **rad** within the range -1.0 to 1.0.

`rad1` is a float with a precision equal to **val** representing an angle in Radians 0 to pi

`rad2` is a float with a precision equal to **val** representing an angle in Radians -pi to pi

Result is a float with a precision equal to **value**

Function:        These functions perform basic Trigonometric functions.  
                  `sin`    returns the sine value of the parameter (measured in radians)  
                  `cos`    returns the cosine value of the parameter (measured in radians)  
                  `tan`    returns the tangent value of the parameter (measured in radians)  
                  `asin`   returns the arc sine value in the range [-pi/2,+pi/2] radians  
                  `acos`   returns the arc cosine value in the range[0,pi] radians  
                  `atan`   returns the arc tangent value in the range [-pi/2,+pi/2] radians  
                  `atan2` returns the arc tangent of y/x in the range [-pi,+pi] radians  
                  `sinh`   returns the hyperbolic sine of x  
                  `cosh`   returns the hyperbolic cosine of x  
                  `tanh`   returns the hyperbolic tangent of x

Note on error handling:

If "errno.h" is included then the domain and range errors are stored in the `errno` variable. The user can check the `errno` to see if an error has occurred and print

the error using the perror function.

Domain error occurs in the following cases:  
 asin: when the argument not in the range[-1,+1]  
 acos: when the argument not in the range[-1,+1]  
 atan2: when both arguments are zero

Range error occur in the following cases:  
 cosh: when the argument is too large  
 sinh: when the argument is too large

Availability: All devices

Requires: #INCLUDE <math.h>

Examples: 

```
float phase;
// Output one sine wave
for(phase=0; phase<2*3.141596; phase+=0.01)
    set_analog_voltage( sin(phase)+1 );
```

Example [ex\\_tank.c](#)

Files:

Also See: [log\(\)](#), [log10\(\)](#), [exp\(\)](#), [pow\(\)](#), [sqrt\(\)](#)

## sleep( )

Syntax: sleep(mode)

Parameters: **mode** configures what sleep mode to enter, mode is optional. If mode is SLEEP\_IDLE, the PIC will stop executing code but the peripherals will still be operational. If mode is SLEEP\_FULL, the PIC will stop executing code and the peripherals will stop being clocked, peripherals that do not need a clock or are using an external clock will still be operational. SLEEP\_FULL will reduce power consumption the most. If no parameter is specified, SLEEP\_FULL will be used.

Returns: Undefined

Function: Issues a SLEEP instruction. Details are device dependent. However, in general the part will enter low power mode and halt program execution until woken by specific external events. Depending on the cause of the wake up execution may continue after the sleep instruction. The compiler inserts a sleep() after the last statement in main().

Availability: All devices

Requires: Nothing

Examples: 

```
disable_interrupts(INT_GLOBAL);
enable_interrupt(INT_EXT);
clear_interrupt();
sleep(SLEEP_FULL); //sleep until an INT_EXT interrupt
//after INT_EXT wake-up, will resume operation from this point
```

Example [ex\\_wakup.c](#)

Files:

Also See: [reset\\_cpu\(\)](#)

## spi\_data\_is\_in( ) spi\_data\_is\_in2( )

Syntax:                result = spi\_data\_is\_in()  
                         result = spi\_data\_is\_in2()

Parameters:           None

Returns:                0 (FALSE) or 1 (TRUE)

Function:               Returns TRUE if data has been received over the SPI.

Availability:           This function is only available on devices with SPI hardware.

Requires:               Nothing

Examples:               

```
( !spi_data_is_in() && input(PIN_B2) );  
if( spi_data_is_in() )  
data = spi_read();
```

Example Files:           None

Also See:               [spi\\_read\(\)](#), [spi\\_write\(\)](#), [SPI Overview](#)

## spi\_read( ) spi\_read2( )

Syntax:                value = spi\_read (*data*)  
                         value = spi\_read2 (*data*)

Parameters:           **data** is optional and if included is an 8 bit int.

Returns:                An 8 bit int

Function:               Return a value read by the SPI. If a value is passed to spi\_read() the data will be clocked out and the data received will be returned. If no data is ready, spi\_read() will wait for the data if A SLAVE or return the last DATA clocked in from spi\_write.

If this device is the master then either do a spi\_write (data) followed by a spi\_read() or do a spi\_read (data). These both do the same thing and will generate a clock. If there is no data to send just do a SPI\_READ(0) to get the clock.

If this device is a slave then either call spi\_read() to wait for the clock and data or use spi\_data\_is\_in() to determine if data is ready.

Availability:           This function is only available on devices with SPI hardware.

Requires:               Nothing

Examples:               

```
in_data = spi_read(out_data);
```

Example Files:           [ex\\_spi.c](#)

Also See:               [spi\\_data\\_is\\_in\(\)](#), [spi\\_write\(\)](#), [SPI Overview](#)

## spi\_write( ) spi\_write2( )

|                |   |
|----------------|---|
| Syntax:        | spi_write ( <i>value</i> )<br>spi_write2 ( <i>value</i> )   |
| Parameters:    | <b>value</b> is an 8 bit int  |
| Returns:       | Nothing   |
| Function:      | Sends a byte out the SPI interface. This will cause 8 clocks to be generated. This function will write the value out to the SPI. At the same time data is clocked out data is clocked in and stored in a receive buffer. spi_read() may be used to read the buffer. |
| Availability:  | This function is only available on devices with SPI hardware.   |
| Requires:      | Nothing   |
| Examples:      | spi_write( data_out );<br>data_in = spi_read();   |
| Example Files: | <a href="#">ex_spi.c</a>  |
| Also See:      | <a href="#">spi_read()</a> , <a href="#">spi_data_is_in()</a> , <a href="#">SPI Overview</a>  |

## spi\_xfer( )

|                |   |
|----------------|---|
| Syntax:        | spi_xfer(data)<br>spi_xfer(stream, data)<br>spi_xfer(stream, data, bits)<br>result = spi_xfer(data)<br>result = spi_xfer(stream, data)<br>result = spi_xfer(stream, data, bits)   |
| Parameters:    | <b>data</b> is the variable or constant to transfer via SPI. The pin used to transfer <b>data</b> is defined in the DO=pin option in #use spi. <b>stream</b> is the SPI stream to use as defined in the STREAM=name option in #USE SPI. <b>bits</b> is how many bits of data will be transferred. |
| Returns:       | The data read in from the SPI. The pin used to transfer result is defined in the DI=pin option in #USE SPI.   |
| Function:      | Transfers data to and reads data from an SPI device.  |
| Availability:  | All devices with SPI support.   |
| Requires:      | #USE SPI  |
| Examples:      | int i = 34;<br>spi_xfer(i);<br>// transfers the number 34 via SPI<br>int trans = 34, res;<br>res = spi_xfer(trans);<br>// transfers the number 34 via SPI<br>// also reads the number coming in from SPI  |
| Example Files: | None  |
| Also See:      | <a href="#">#USE SPI</a>  |

## sprintf( )

|                |   |
|----------------|---|
| Syntax:        | <code>sprintf(<b>string</b>, <b>cstring</b>, <b>values...</b>);</code><br><code>bytes=sprintf(<b>string</b>, <b>cstring</b>, <b>values...</b>)</code>   |
| Parameters:    | <b>string</b> is an array of characters.<br><b>cstring</b> is a constant string or an array of characters null terminated. <b>Values</b> are a list of variables separated by commas. Note that format specifiers do not work in ram band strings.                |
| Returns:       | Bytes is the number of bytes written to string.   |
| Function:      | This function operates like printf() except that the output is placed into the specified string. The output string will be terminated with a null. No checking is done to ensure the string is large enough for the data. See printf() for details on formatting. |
| Availability:  | All devices.  |
| Requires:      | Nothing   |
| Examples:      | <pre>char mystring[20]; long mylong;  mylong=1234; sprintf(mystring, "&lt;%lu&gt;", mylong); // mystring now has: // &lt; 1 2 3 4 &gt; \0</pre>   |
| Example Files: | None  |
| Also See:      | <a href="#">printf()</a>  |

## sqrt( )

|               |   |
|---------------|---|
| Syntax:       | <code>result = sqrt (<b>value</b>)</code>   |
| Parameters:   | <b>value</b> is any float type  |
| Returns:      | Returns a floating point value with a precision equal to <b>value</b>   |
| Function:     | Computes the non-negative square root of the float value x. If the argument is negative, the behavior is undefined.<br><br>Note on error handling:<br>If "errno.h" is included then the domain and range errors are stored in the errno variable. The user can check the errno to see if an error has occurred and print the error using the perror function.<br><br>Domain error occurs in the following cases:<br>sqrt: when the argument is negative |
| Availability: | All devices.  |

Requires: #INCLUDE <math.h>

Examples: `distance = sqrt( pow((x1-x2),2)+pow((y1-y2),2) );`

Example Files: None

Also See: None

## rand( )

Syntax: `rand(n)`

Parameters: *n* is the seed for a new sequence of pseudo-random numbers to be returned by subsequent calls to rand.

Returns: No value.

Function: The rand() function uses the argument as a seed for a new sequence of pseudo-random numbers to be returned by subsequent calls to rand. If rand() is then called with same seed value, the sequence of random numbers shall be repeated. If rand is called before any call to srand() have been made, the same sequence shall be generated as when srand() is first called with a seed value of 1.

Availability: All devices.

Requires: #INCLUDE <STDLIB.H>

Examples: `srand(10);`  
`I=rand();`

Example Files: None

Also See: [rand\(\)](#)

## STANDARD STRING FUNCTIONS( ) memchr( ) memcmp( ) strcat( ) strchr( ) strcmp( ) strcoll( ) strcspn( ) strerror( )

## stricmp( ) strlen( ) strlwr( ) strncat( ) strncmp( ) strncpy( ) strpbrk( ) strchr( ) strspn( ) strstr( ) strxfrm( )

|         |   |  |
|---------|---|--|
| Syntax: | ptr=strcat ( <b>s1</b> , <b>s2</b> )                | Concatenate s2 onto s1   |
|         | ptr=strchr ( <b>s1</b> , <b>c</b> )                 | Find c in s1 and return &s1[i]   |
|         | ptr=strrchr ( <b>s1</b> , <b>c</b> )                | Same but search in reverse   |
|         | result=strcmp ( <b>s1</b> , <b>s2</b> )             | Compare s1 to s2   |
|         | result=strncmp ( <b>s1</b> , <b>s2</b> , <b>n</b> ) | Compare s1 to s2 (n bytes)   |
|         | result=stricmp ( <b>s1</b> , <b>s2</b> )            | Compare and ignore case  |
|         | ptr=strncpy ( <b>s1</b> , <b>s2</b> , <b>n</b> )    | Copy up to n characters s2->s1   |
|         | result=strcspn ( <b>s1</b> , <b>s2</b> )            | Count of initial chars in s1 not in s2   |
|         | result=strspn ( <b>s1</b> , <b>s2</b> )             | Count of initial chars in s1 also in s2  |
|         | result=strlen ( <b>s1</b> )                         | Number of characters in s1   |
|         | ptr=strlwr ( <b>s1</b> )                            | Convert string to lower case   |
|         | ptr=strpbrk ( <b>s1</b> , <b>s2</b> )               | Search s1 for first char also in s2  |
|         | ptr=strstr ( <b>s1</b> , <b>s2</b> )                | Search for s2 in s1  |
|         | ptr=strncat( <b>s1</b> , <b>s2</b> )                | Concatenates up to n bytes of s2 onto s1   |
|         | result=strcoll( <b>s1</b> , <b>s2</b> )             | Compares s1 to s2, both interpreted as appropriate to the current locale.  |
|         | res=strxfrm( <b>s1</b> , <b>s2</b> , <b>n</b> )     | Transforms maximum of n characters of s2 and places them in s1, such that strcmp(s1,s2) will give the same result as strcoll(s1,s2)          |
|         | result=memcmp( <b>m1</b> , <b>m2</b> , <b>n</b> )   | Compare m1 to m2 (n bytes)   |
|         | ptr=memchr( <b>m1</b> , <b>c</b> , <b>n</b> )       | Find c in first n characters of m1 and return &m1[i]   |
|         | ptr=strerror(ernum)                                 | Maps the error number in ernum to an error message string. The parameters 'ernum' is an unsigned 8 bit int. Returns a pointer to the string. |

Parameters: **s1** and **s2** are pointers to an array of characters (or the name of an array). Note that s1 and s2 MAY NOT BE A CONSTANT (like "hi").

**n** is a count of the maximum number of character to operate on.

**c** is a 8 bit character

**m1** and **m2** are pointers to memory.



Returns: ptr is a copy of the s1 pointer  
 ireturn is an 8 bit int  
 result is -1 (less than), 0 (equal) or 1 (greater than)  
 res is an integer.

Function: Functions are identified above.

Availability: All devices.

Requires: `#include <string.h>`

Examples: 

```
char string1[10], string2[10];

strcpy(string1, "hi ");
strcpy(string2, "there");
strcat(string1, string2);

printf("Length is %u\r\n", strlen(string1));
// Will print 8
```

Example Files: [ex\\_str.c](#)

Also See: [strcpy\(\)](#), [strtok\(\)](#)

## strcat( )

See: [STANDARD STRING FUNCTIONS\(\)](#)

## strchr( )

See: [STANDARD STRING FUNCTIONS\(\)](#)

## strcmp( )

See: [STANDARD STRING FUNCTIONS\(\)](#)

## strcoll( )

See: [STANDARD STRING FUNCTIONS\(\)](#)

## strcpy( ) strcpy( )

Syntax:            strcpy (*dest*, *src*)  
                  strcpy (*dest*, *src*)

Parameters:        **dest** is a pointer to a RAM array of characters.  
                  **src** may be either a pointer to a RAM array of characters or it may be a constant string.

Returns:            undefined

Function:           Copies a constant or RAM string to a RAM string. Strings are terminated with a 0.

Availability:      All devices.

Requires:          Nothing

Examples:          char string[10], string2[10];  
                  .  
                  .  
                  strcpy (string, "Hi There");  
  
                  strcpy(string2, string);

Example Files:     [ex\\_str.c](#)

Also See:          [strxxxx\(\)](#)

## STRCSPN( )

See: [STANDARD STRING FUNCTIONS\( \)](#)

## strlen( )

See: [STANDARD STRING FUNCTIONS\( \)](#)

## strlwr( )

See: [STANDARD STRING FUNCTIONS\( \)](#)

## **strncat( )**

See: [STANDARD STRING FUNCTIONS\(\)](#)

## **strncmp( )**

See: [STANDARD STRING FUNCTIONS\(\)](#)

## **strncpy( )**

See: [STANDARD STRING FUNCTIONS\(\)](#)

## **strpbrk( )**

See: [STANDARD STRING FUNCTIONS\(\)](#)

## **strchr( )**

See: [STANDARD STRING FUNCTIONS\(\)](#)

## **strcspn( )**

See: [STANDARD STRING FUNCTIONS\(\)](#)

## **strstr( )**

See: [STANDARD STRING FUNCTIONS\(\)](#)

## **strtod( ) strtod( ) strtod48( )**

Syntax:            result=strtod(*nptr*,& *endptr*)  
                    result=strtod(*nptr*,& *endptr*)

```
result=strtod(nptr,& endptr)
```

Parameters: *nptr* and *endptr* are strings

Returns: strtod returns a double precision floating point number.  
 strtod returns a single precision floating point number.  
 strtod48 returns an extended precision floating point number.  
 returns the converted value in result, if any. If no conversion could be performed, zero is returned.

Function: The strtod function converts the initial portion of the string pointed to by *nptr* to a float representation. The part of the string after conversion is stored in the object pointed to *endptr*, provided that *endptr* is not a null pointer. If *nptr* is empty or does not have the expected form, no conversion is performed and the value of *nptr* is stored in the object pointed to by *endptr*, provided *endptr* is not a null pointer.

Availability: All devices.

Requires: #INCLUDE <stdlib.h>

Examples: 

```
double result;
char str[12]="123.45hello";
char *ptr;
result=strtod(str,&ptr);
//result is 123.45 and ptr is "hello"
```

Example: None

Files:

Also See: [strtol\(\)](#), [strtoul\(\)](#)

## strtok( )

Syntax: ptr = strtok(*s1*, *s2*)

Parameters: *s1* and *s2* are pointers to an array of characters (or the name of an array). Note that *s1* and *s2* MAY NOT BE A CONSTANT (like "hi"). *s1* may be 0 to indicate a continue operation.

Returns: ptr points to a character in *s1* or is 0

Function: Finds next token in *s1* delimited by a character from separator string *s2* (which can be different from call to call), and returns pointer to it.  
  
 First call starts at beginning of *s1* searching for the first character NOT contained in *s2* and returns null if there is none are found.

If none are found, it is the start of first token (return value). Function then searches from there for a character contained in s2.

If none are found, current token extends to the end of s1, and subsequent searches for a token will return null.

If one is found, it is overwritten by '\0', which terminates current token. Function saves pointer to following character from which next search will start.

Each subsequent call, with 0 as first argument, starts searching from the saved pointer.

Availability: All devices.

Requires: #INCLUDE <string.h>

```
Examples: char string[30], term[3], *ptr;

strcpy(string, "one,two,three;");
strcpy(term, ",;");

ptr = strtok(string, term);
while(ptr!=0) {
    puts(ptr);
    ptr = strtok(0, term);
}

// Prints:
    one
    two
    three
```

Example [ex\\_str.c](#)

Files:

Also See: [strxxx\(\)](#), [strcpy\(\)](#)

## strtol( )

Syntax: result=strtol(*nptr*,& *endptr*, *base*)

Parameters: *nptr* and *endptr* are strings and *base* is an integer

Returns: result is a signed long int.  
returns the converted value in result , if any. If no conversion could be performed, zero is returned.

Function: The strtol function converts the initial portion of the string pointed to by *nptr* to a signed long int representation in some radix determined by the value of *base*.

The part of the string after conversion is stored in the object pointed to `endptr`, provided that `endptr` is not a null pointer. If `nptr` is empty or does not have the expected form, no conversion is performed and the value of `nptr` is stored in the object pointed to by `endptr`, provided `endptr` is not a null pointer.

Availability: All devices.

Requires: `#INCLUDE <stdlib.h>`

Examples: 

```
signed long result;
char str[9]="123hello";
char *ptr;
result=strtoul(str,&ptr,10);
//result is 123 and ptr is "hello"
```

Example: None

Files:

Also See: [strtod\(\)](#), [strtol\(\)](#)

## strtoul( )

Syntax: `result=strtoul(nptr,endptr, base)`

Parameters: *nptr* and *endptr* are strings pointers and *base* is an integer 2-36.

Returns: result is an unsigned long int.  
returns the converted value in result , if any. If no conversion could be performed, zero is returned.

Function: The `strtoul` function converts the initial portion of the string pointed to by `nptr` to a long int representation in some radix determined by the value of `base`. The part of the string after conversion is stored in the object pointed to `endptr`, provided that `endptr` is not a null pointer. If `nptr` is empty or does not have the expected form, no conversion is performed and the value of `nptr` is stored in the object pointed to by `endptr`, provided `endptr` is not a null pointer.

Availability: All devices.

Requires: `STDLIB.H` must be included

Examples: 

```
long result;
char str[9]="123hello";
char *ptr;
result=strtoul(str,&ptr,10);
//result is 123 and ptr is "hello"
```

Example: None

Files:

Also See: [strtol\(\)](#), [strtod\(\)](#)

## strxfrm( )

See: [STANDARD STRING FUNCTIONS\( \)](#)

## swap( )

Syntax:            swap (*lvalue*)  
                    result = swap(*lvalue*)

Parameters:        *lvalue* is a byte variable

Returns:            A byte

Function:            Swaps the upper nibble with the lower nibble of the specified byte. This is the same as:  
                    byte = (byte << 4) | (byte >> 4);

Availability:        All devices.

Requires:            Nothing

Examples:            

```
x=0x45;
swap(x);
//x now is 0x54

int x = 0x42;
int result;
result = swap(x);
// result is 0x24;
```

Example Files:        None

Also See:            [rotate\\_right\(\)](#), [rotate\\_left\(\)](#)

## tolower( ) toupper( )

Syntax:            result = tolower (*cvalue*)  
                    result = toupper (*cvalue*)

Parameters:        *cvalue* is a character

Returns:            An 8 bit character

Function:            These functions change the case of letters in the alphabet.

                    TOLOWER(X) will return 'a'..'z' for X in 'A'..'Z' and all other characters are

unchanged. `TOUPPER(X)` will return 'A'..'Z' for X in 'a'..'z' and all other characters are unchanged.

**Availability:** All devices.

**Requires:** Nothing

**Examples:**

```
switch( toupper(getc()) ) {
    case 'R' : read_cmd(); break;
    case 'W' : write_cmd(); break;
    case 'Q' : done=TRUE; break;
}
```

**Example Files:** [ex\\_str.c](#)

**Also See:** None

## touchpad\_getc()

**Syntax:** `input = TOUCHPAD_GETC();`

**Parameters:** None

**Returns:** char (returns corresponding ASCII number is "input" declared as int)

**Function:** Actively waits for firmware to signal that a pre-declared Capacitive Sensing Module (CSM) pin is active, then stores the pre-declared character value of that pin in "input".

**Note:** Until a CSM pin is read by firmware as active, this instruction will cause the microcontroller to stall.

**Availability:** All PIC's with a CSM Module

**Requires:** `#USE TOUCHPAD (options)`

**Examples:** //When the pad connected to PIN\_B0 is activated, store the letter 'A'

```
#USE TOUCHPAD (PIN_B0='A')
void main(void){
    char c;
    enable_interrupts(GLOBAL);

    c = TOUCHPAD_GETC();
    //will wait until one of declared pins is detected
    //if PIN_B0 is pressed, c will get value 'A'
}
```

**Example Files:** None

**Files:**

**Also See:** [#USE TOUCHPAD](#), [touchpad\\_state\(\)](#)



## touchpad\_hit( )

Syntax: value = TOUCHPAD\_HIT( ). if( TOUCHPAD\_HIT( ) )

Parameters: None

Returns: TRUE or FALSE

Function: Returns TRUE if a Capacitive Sensing Module (CSM) key has been pressed. If TRUE, then a call to touchpad\_getc() will not cause the program to wait for a key press.

Availability: All PIC's with a CSM Module

Requires: #USE TOUCHPAD (options)

Examples: // When the pad connected to PIN\_B0 is activated, store the letter 'A'

```
#USE TOUCHPAD (PIN_B0='A')
void main(void){
    char c;
    enable_interrupts(GLOBAL);

    while (TRUE) {
        if ( TOUCHPAD_HIT() )
            //wait until key on PIN_B0 is pressed
            c = TOUCHPAD_GETC();           //get key that was pressed
        }
        //c will get value 'A'
    }
}
```

Example: None

Files:

Also See: [#USE TOUCHPAD \( \)](#), [touchpad\\_state\( \)](#), [touchpad\\_getc\( \)](#)

## touchpad\_state( )

Syntax: TOUCHPAD\_STATE (*state*);

Parameters: **state** is a literal 0, 1, or 2.

Returns: None

Function: Sets the current state of the touchpad connected to the Capacitive Sensing Module (CSM). The state can be one of the following three values:

- 0 : Normal state
- 1 : Calibrates, then enters normal state
- 2 : Test mode, data from each key is collected in the int16 array TOUCHDATA

Note: If the state is set to 1 while a key is being pressed, the touchpad will not calibrate properly.

Availability: All PIC's with a CSM Module

|                       |   |
|-----------------------|---|
| <b>Requires:</b>      | <b>#USE TOUCHPAD (options)</b>  |
| <b>Examples:</b>      | <pre>#USE TOUCHPAD (THRESHOLD=5, PIN_D5='5', PIN_B0='C') void main(void){     char c;     TOUCHPAD_STATE(1);    //calibrates, then enters normal state     enable_interrupts(GLOBAL);     while(1){         c = TOUCHPAD_GETC();         //will wait until one of declared pins is detected     }     //if PIN_B0 is pressed, c will get value 'C'     //if PIN_D5 is pressed, c will get value '5' }</pre> |
| <b>Example Files:</b> | None  |
| <b>Also See:</b>      | <a href="#">#USE TOUCHPAD</a> , <a href="#">touchpad_getc()</a> , <a href="#">touchpad_hit()</a>  |

## va\_arg( )

|                       |  |
|-----------------------|--|
| <b>Syntax:</b>        | va_arg(argptr, type)   |
| <b>Parameters:</b>    | argptr is a special argument pointer of type va_list<br><br>type – This is data type like int or char.   |
| <b>Returns:</b>       | The first call to va_arg after va_start return the value of the parameters after that specified by the last parameter. Successive invocations return the values of the remaining arguments in succession.  |
| <b>Function:</b>      | The function will return the next argument every time it is called.  |
| <b>Availability:</b>  | All devices.   |
| <b>Requires:</b>      | #INCLUDE <stdarg.h>  |
| <b>Examples:</b>      | <pre>int foo(int num, ...) {     int sum = 0;     int i;     va_list argptr; // create special argument pointer     va_start(argptr,num); // initialize argptr     for(i=0; i&lt;num; i++)         sum = sum + va_arg(argptr, int);     va_end(argptr); // end variable processing     return sum; }</pre> |
| <b>Example Files:</b> | None   |
| <b>Also See:</b>      | <a href="#">nargs()</a> , <a href="#">va_end()</a> , <a href="#">va_start()</a>  |

## va\_end( )

Syntax:        va\_end(argptr)

Parameters:    argptr is a special argument pointer of type va\_list.

Returns:       None

Function:      A call to the macro will end variable processing. This will facilitate a normal return from the function whose variable argument list was referred to by the expansion of va\_start().

Availability:  All devices.

Requires:      #include <stdarg.h>

```
Examples:
int foo(int num, ...)
{
    int sum = 0;
    int i;
    va_list argptr; // create special argument pointer
    va_start(argptr,num); // initialize argptr
    for(i=0; i<num; i++)
        sum = sum + va_arg(argptr, int);
    va_end(argptr); // end variable processing
    return sum;
}
```

Example Files:   None

Also See:       [nargs\(\)](#), [va\\_start\(\)](#), [va\\_arg\(\)](#)

## va\_start

Syntax:        va\_start(argptr, variable)

Parameters:    argptr is a special argument pointer of type va\_list

variable – The second parameter to va\_start() is the name of the last parameter before the variable-argument list.

Returns:       None

Function:      The function will initialize the argptr using a call to the macro va\_start().

## TEST PCD

Availability: All devices.

Requires: #INCLUDE <stdarg.h>

```
Examples: int foo(int num, ...)
{
  int sum = 0;
  int i;
  va_list argptr; // create special argument pointer
  va_start(argptr,num); // initialize argptr
  for(i=0; i<num; i++)
    sum = sum + va_arg(argptr, int);
  va_end(argptr); // end variable processing
  return sum;
}
```

Example Files: None

Also See: [nargs\(\)](#), [va\\_start\(\)](#), [va\\_arg\(\)](#)

## write\_configuration\_memory()

Syntax: write\_configuration\_memory (***dataptr***, ***count***)

Parameters: ***dataptr***: pointer to one or more bytes  
***count***: a 8 bit integer

Returns: undefined

Function: Erases all fuses and writes count bytes from the dataptr to the configuration memory.

Availability: All PIC18 flash devices

Requires: Nothing

```
Examples: int data[6];
write_configuration_memory(data,6)
```

Example Files: None

Also See: [write\\_program\\_memory\(\)](#), Configuration Memory Overview

## write\_eeprom( )

Syntax:            write\_eeprom (**address**, **value**)  
                   write\_eeprom ( **address** , **pointer** , **N** )

Parameters:      **address** is the 0 based starting location of the EEPROM write  
**N** specifies the number of EEPROM bytes to write  
**value** is a constant or variable to write to EEPROM  
**pointer** is a pointer to location to data to be written to EEPROM

Returns:            undefined

Function:          This function will write the specified value to the given address of EEPROM. If pointers are used than the function will write n bytes of data from the pointer to EEPROM starting at the value of address.  
 In order to allow interrupts to occur while using the write operation, use the #DEVICE option WRITE\_EEPROM = NOINT. This will allow interrupts to occur while the write\_eeprom() operations is polling the done bit to check if the write operations has completed. Can be used as long as no EEPROM operations are performed during an ISR.

Availability:      This function is only available on devices with supporting hardware on chip.

Requires:          Nothing

Examples:          #define LAST\_VOLUME 10        // Location in EEPROM  
  
                   volume++;  
                   write\_eeprom(LAST\_VOLUME, volume);

Example Files:     None

Also See:          [read\\_eeprom\(\)](#), [write\\_program\\_eeprom\(\)](#), [read\\_program\\_eeprom\(\)](#), [data Eeprom Overview](#)

## write\_extended\_ram( )

Syntax:            write\_extended\_ram (**page**,**address**,**data**,**count**);

Parameters:      **page** – the page in extended RAM to write to  
**address** – the address on the selected page to start writing to  
**data** – pointer to the data to be written  
**count** – the number of bytes to write (0-32768)

## TEST PCD

Returns: undefined

Function: To write data to the extended RAM of the PIC.

Availability: On devices with more than 30K of RAM.

Requires: Nothing

Examples: 

```
unsigned int8 data[8] =
{0x01,0x02,0x03,0x04,0x05,0x06,0x07,0x08};

write_extended_ram(1,0x0000,data,8);
```

Example Files: None

Also See: [read\\_extended\\_ram\(\)](#), [Extended RAM Overview](#)

## write\_program\_memory( )

Syntax: write\_program\_memory( *address*, *dataptr*, *count* );

Parameters: **address** is 32 bits .  
**dataptr** is a pointer to one or more bytes  
**count** is a 16 bit integer on PIC16 and 16-bit for PIC18

Returns: undefined

Function: Writes count bytes to program memory from dataptr to address. This function is most effective when count is a multiple of FLASH\_WRITE\_SIZE, but count needs to be a multiple of four. Whenever this function is about to write to a location that is a multiple of FLASH\_ERASE\_SIZE then an erase is performed on the whole block. Due to the 24 bit instruction length on PCD parts, every fourth byte of data is ignored. Fill the ignored bytes with 0x00.

See Program EEPROM Overview for more information on program memory access

Availability: Only devices that allow writes to program memory.

Requires: Nothing

Examples: 

```
for(i=0x1000;i<=0x1fff;i++) {
    value=read_adc();
    write_program_memory(i, value, 2);
    delay_ms(1000);
}

int8 write_data[4] = {0x10,0x20,0x30,0x00};
write_program_memory (0x2000, write_data, 4);
```

Example Files: None

# STANDARD C INCLUDE FILES



C Compiler

## errno.h

| errno.h |                    |
|---------|--------------------|
| EDOM    | Domain error value |
| ERANGE  | Range error value  |
| errno   | error value        |

## float.h

| float.h         |   |
|-----------------|---|
| FLT_RADIX:      | Radix of the exponent representation  |
| FLT_MANT_DIG:   | Number of base digits in the floating point significant   |
| FLT_DIG:        | Number of decimal digits, q, such that any floating point number with q decimal digits can be rounded into a floating point number with p radix b digits and back again without change to the q decimal digits. |
| FLT_MIN_EXP:    | Minimum negative integer such that FLT_RADIX raised to that power minus 1 is a normalized floating-point number.  |
| FLT_MIN_10_EXP: | Minimum negative integer such that 10 raised to that power is in the range of normalized floating-point numbers.  |
| FLT_MAX_EXP:    | Maximum negative integer such that FLT_RADIX raised to that power minus 1 is a representable finite floating-point number.  |
| FLT_MAX_10_EXP: | Maximum negative integer such that 10 raised to that power is in the range representable finite floating-point numbers.   |
| FLT_MAX:        | Maximum representable finite floating point number.   |
| FLT_EPSILON:    | The difference between 1 and the least value greater than 1 that is representable in the given floating point type.   |
| FLT_MIN:        | Minimum normalized positive floating point number   |
| DBL_MANT_DIG:   | Number of base digits in the double significant   |
| DBL_DIG:        | Number of decimal digits, q, such that any double number with q decimal digits can be rounded into a double number with p radix b digits and back again without change to the q decimal digits.                 |
| DBL_MIN_EXP:    | Minimum negative integer such that FLT_RADIX raised to that power minus 1 is a normalized double number.  |
| DBL_MIN_10_EXP: | Minimum negative integer such that 10 raised to that power is in the range of normalized double numbers.  |
| DBL_MAX_EXP:    | Maximum negative integer such that FLT_RADIX raised to that power minus 1 is a representable finite double number.  |

|                  |   |
|------------------|---|
| DBL_MAX_10_EXP:  | Maximum negative integer such that 10 raised to that power is in the range of representable finite double numbers.  |
| DBL_MAX:         | Maximum representable finite floating point number.   |
| DBL_EPSILON:     | The difference between 1 and the least value greater than 1 that is representable in the given floating point type.   |
| DBL_MIN:         | Minimum normalized positive double number.  |
| LDBL_MANT_DIG:   | Number of base digits in the floating point significant   |
| LDBL_DIG:        | Number of decimal digits, q, such that any floating point number with q decimal digits can be rounded into a floating point number with p radix b digits and back again without change to the q decimal digits. |
| LDBL_MIN_EXP:    | Minimum negative integer such that FLT_RADIX raised to that power minus 1 is a normalized floating-point number.  |
| LDBL_MIN_10_EXP: | Minimum negative integer such that 10 raised to that power is in the range of normalized floating-point numbers.  |
| LDBL_MAX_EXP:    | Maximum negative integer such that FLT_RADIX raised to that power minus 1 is a representable finite floating-point number.  |
| LDBL_MAX_10_EXP: | Maximum negative integer such that 10 raised to that power is in the range of representable finite floating-point numbers.  |
| LDBL_MAX:        | Maximum representable finite floating point number.   |
| LDBL_EPSILON:    | The difference between 1 and the least value greater than 1 that is representable in the given floating point type.   |
| LDBL_MIN:        | Minimum normalized positive floating point number.  |

## limits.h

| limits.h    |   |
|-------------|---|
| CHAR_BIT:   | Number of bits for the smallest object that is not a bit_field. |
| SCHAR_MIN:  | Minimum value for an object of type signed char                 |
| SCHAR_MAX:  | Maximum value for an object of type signed char                 |
| UCHAR_MAX:  | Maximum value for an object of type unsigned char               |
| CHAR_MIN:   | Minimum value for an object of type char(unsigned)              |
| CHAR_MAX:   | Maximum value for an object of type char(unsigned)              |
| MB_LEN_MAX: | Maximum number of bytes in a multibyte character.               |
| SHRT_MIN:   | Minimum value for an object of type short int                   |
| SHRT_MAX:   | Maximum value for an object of type short int                   |
| USHRT_MAX:  | Maximum value for an object of type unsigned short int          |
| INT_MIN:    | Minimum value for an object of type signed int                  |
| INT_MAX:    | Maximum value for an object of type signed int                  |
| UINT_MAX:   | Maximum value for an object of type unsigned int                |
| LONG_MIN:   | Minimum value for an object of type signed long int             |
| LONG_MAX:   | Maximum value for an object of type signed long int             |
| ULONG_MAX:  | Maximum value for an object of type unsigned long int           |



## locale.h

| locale.h    |                              |
|-------------|------------------------------|
| locale.h    | (Localization not supported) |
| lconv       | localization structure       |
| SETLOCALE() | returns null                 |
| LOCALCONV() | returns clocale              |

## setjmp.h

| setjmp.h |   |
|----------|---|
| jmp_buf: | An array used by the following functions  |
| setjmp:  | Marks a return point for the next longjmp |
| longjmp: | Jumps to the last marked point            |

## stddef.h

| stddef.h   |   |
|------------|---|
| ptrdiff_t: | The basic type of a pointer                                     |
| size_t:    | The type of the sizeof operator (int)                           |
| wchar_t    | The type of the largest character set supported (char) (8 bits) |
| NULL       | A null pointer (0)  |

## stdio.h

| stdio.h |  |
|---------|--|
| stderr  | The standard error s stream (USE RS232 specified as stream or the first USE RS232) |
| stdout  | The standard output stream (USE RS232 specified as stream last USE RS232)          |
| stdin   | The standard input s stream (USE RS232 specified as stream last USE RS232)         |

## stdlib.h

| stdlib.h     |  |
|--------------|--|
| div_t        | structure type that contains two signed integers (quot and rem). |
| ldiv_t       | structure type that contains two signed longs (quot and rem)     |
| EXIT_FAILURE | returns 1  |

## TEST PCD

|   |                                    |
|---|------------------------------------|
| EXIT_SUCCESS                              | returns 0                          |
| RAND_MAX-                                 |                                    |
| MBCUR_MAX-                                | 1                                  |
| SYSTEM()                                  | Returns 0( not supported)          |
| Multibyte character and string functions: | Multibyte characters not supported |
| MBLEN()                                   | Returns the length of the string.  |
| MBTOWC()                                  | Returns 1.                         |
| WCTOMB()                                  | Returns 1.                         |
| MBSTOWCS()                                | Returns length of string.          |
| WBSTOMBS()                                | Returns length of string.          |

Stdlib.h functions included just for compliance with ANSI C.

# ERROR MESSAGES



## Compiler Error Messages

### **# ENDIF with no corresponding #IF**

Compiler found a #ENDIF directive without a corresponding #IF.

#ERROR

A #DEVICE required before this line

The compiler requires a #device before it encounters any statement or compiler directive that may cause it to generate code. In general #defines may appear before a #device but not much more.

### **ADDRESSMOD function definition is incorrect**

#### **ADDRESSMOD range is invalid**

A numeric expression must appear here

Some C expression (like 123, A or B+C) must appear at this spot in the code. Some expression that will evaluate to a value.

Arrays of bits are not permitted

Arrays may not be of SHORT INT. Arrays of Records are permitted but the record size is always rounded up to the next byte boundary.

#### **Assignment invalid: value is READ ONLY**

Attempt to create a pointer to a constant

Constant tables are implemented as functions. Pointers cannot be created to functions. For example CHAR CONST MSG[9]="HI THERE"; is permitted, however you cannot use &MSG. You can only reference MSG with subscripts such as MSG[i] and in some function calls such as Printf and STRCPY.

Attributes used may only be applied to a function (INLINE or SEPARATE)

An attempt was made to apply #INLINE or #SEPARATE to something other than a function.

#### **Bad ASM syntax**

Bad expression syntax

This is a generic error message. It covers all incorrect syntax.

Baud rate out of range

The compiler could not create code for the specified baud rate. If the internal UART is being used the combination of the clock and the UART capabilities could not get a baud rate within 3% of the requested value. If the built in UART is not being used then the clock will not permit the indicated baud rate. For fast baud rates, a faster clock will be required.

BIT variable not permitted here

Addresses cannot be created to bits. For example &X is not permitted if X is a SHORT INT.

#### **Branch out of range**

Cannot change device type this far into the code

The #DEVICE is not permitted after code is generated that is device specific. Move the #DEVICE to an area before code is generated.

Character constant constructed incorrectly

Generally this is due to too many characters within the single quotes. For example 'ab' is an error as is '\nr'. The backslash is permitted provided the result is a single character such as '\010' or '\n'.

Constant out of the valid range

This will usually occur in inline assembly where a constant must be within a particular range and it is not. For example BTFSC 3,9 would cause this error since the second operand must be from 0-8.

**Data item too big**

Define expansion is too large

A fully expanded DEFINE must be less than 255 characters. Check to be sure the DEFINE is not recursively defined.

Define syntax error

This is usually caused by a missing or misplaced (or) within a define.

Demo period has expired

Please contact CCS to purchase a licensed copy.

[www.ccsinfo.com/pricing](http://www.ccsinfo.com/pricing)

Different levels of indirection

This is caused by a INLINE function with a reference parameter being called with a parameter that is not a variable. Usually calling with a constant causes this.

Divide by zero

An attempt was made to divide by zero at compile time using constants.

Duplicate case value

Two cases in a switch statement have the same value.

Duplicate DEFAULT statements

The DEFAULT statement within a SWITCH may only appear once in each SWITCH. This error indicates a second DEFAULT was encountered.

Duplicate function

A function has already been defined with this name. Remember that the compiler is not case sensitive unless a #CASE is used.

Duplicate Interrupt Procedure

Only one function may be attached to each interrupt level. For example the #INT\_RB may only appear once in each program.

Element is not a member

A field of a record identified by the compiler is not actually in the record. Check the identifier spelling.

ELSE with no corresponding IF

Compiler found an ELSE statement without a corresponding IF. Make sure the ELSE statement always match with the previous IF statement.

End of file while within define definition

The end of the source file was encountered while still expanding a define. Check for a missing ).

End of source file reached without closing comment \*/ symbol

The end of the source file has been reached and a comment (started with /\*) is still in effect. The /\* is missing.

type are INT and CHAR.

Expect ;  
Expect }  
Expect CASE  
Expect comma  
Expect WHILE  
Expecting \*  
Expecting :  
Expecting <  
Expecting =  
Expecting >  
Expecting a (  
Expecting a , or )  
Expecting a , or }  
Expecting a .  
Expecting a ; or ,  
Expecting a ; or {  
Expecting a close paren  
Expecting a declaration  
Expecting a structure/union  
Expecting a variable  
Expecting an =  
Expecting a ]  
Expecting a {  
Expecting an array  
Expecting an identifier  
Expecting function name  
Expecting an opcode mnemonic  
This must be a Microchip mnemonic such as MOVLW or BTFSC.  
Expecting LVALUE such as a variable name or \* expression  
This error will occur when a constant is used where a variable should be. For example 4=5; will give this error.  
Expecting a basic type  
Examples of a basic type are INT and CHAR.

Expression must be a constant or simple variable  
The indicated expression must evaluate to a constant at compile time. For example 5\*3+1 is permitted but 5\*x+1 where X is a INT is not permitted. If X were a DEFINE that had a constant value then it is permitted.  
Expression must evaluate to a constant  
The indicated expression must evaluate to a constant at compile time. For example 5\*3+1 is permitted but 5\*x+1 where X is a INT is not permitted. If X were a DEFINE that had a constant value then it is permitted.  
Expression too complex  
This expression has generated too much code for the compiler to handle for a single expression. This is very rare but if it happens, break the expression up into smaller parts.

Too many assembly lines are being generated for a single C statement. Contact CCS to increase the internal limits.

**EXTERNAL symbol not found****EXTERNAL symbol type mis-match**

Extra characters on preprocessor command line

Characters are appearing after a preprocessor directive that do not apply to that directive.

Preprocessor commands own the entire line unlike the normal C syntax. For example the following is an error:

```
#PRAGMA DEVICE <PIC16C74> main() { int x; x=1;}
```

File cannot be opened

Check the filename and the current path. The file could not be opened.

File cannot be opened for write

The operating system would not allow the compiler to create one of the output files. Make sure the file is not marked READ ONLY and that the compiler process has write privileges to the directory and file.

Filename must start with " or <

The correct syntax of a #include is one of the following two formats:

```
#include "filename.ext"
```

```
#include <filename.ext>
```

This error indicates neither a " or < was found after #include.

Filename must terminate with " or; msg:''

The filename specified in a #include must terminate with a " if it starts with a ". It must terminate with a > if it starts with a <.

Floating-point numbers not supported for this operation

A floating-point number is not permitted in the operation near the error. For example, ++F where F is a float is not allowed.

Function definition different from previous definition

This is a mis-match between a function prototype and a function definition. Be sure that if a #INLINE or #SEPARATE are used that they appear for both the prototype and definition. These directives are treated much like a type specifier.

Function used but not defined

The indicated function had a prototype but was never defined in the program.

Identifier is already used in this scope

An attempt was made to define a new identifier that has already been defined.

Illegal C character in input file

A bad character is in the source file. Try deleting the line and re-typing it.

**Import error**

Improper use of a function identifier

Function identifiers may only be used to call a function. An attempt was made to otherwise reference a function. A function identifier should have a ( after it.

Incorrectly constructed label

This may be an improperly terminated expression followed by a label. For example:

```
x=5+
```

```
MPLAB:
```

Initialization of unions is not permitted

Structures can be initialized with an initial value but UNIONS cannot be.

Internal compiler limit reached

The program is using too much of something. An internal compiler limit was reached. Contact CCS and the limit may be able to be expanded.

**Internal Error - Contact CCS**

This error indicates the compiler detected an internal inconsistency. This is not an error with the source code; although, something in the source code has triggered the internal error. This problem can usually be quickly corrected by sending the source files to CCS so the problem can be re-created and corrected.

In the meantime if the error was on a particular line, look for another way to perform the same operation. The error was probably caused by the syntax of the identified statement. If the error was the last line of the code, the problem was in linking. Look at the call tree for something out of the ordinary.

**Interrupt handler uses too much stack**

Too many stack locations are being used by an interrupt handler.

**Invalid conversion from LONG INT to INT**

In this case, a LONG INT cannot be converted to an INT. You can type cast the LONG INT to perform a truncation. For example:

```
I = INT(LI);
```

**Invalid interrupt directive**

**Invalid parameters to built in function**

Built-in shift and rotate functions (such as SHIFT\_LEFT) require an expression that evaluates to a constant to specify the number of bytes.

**Invalid Pre-Processor directive**

The compiler does not know the preprocessor directive. This is the identifier in one of the following two places:

```
#xxxxxx
```

```
#PRAGMA xxxxxx
```

**Invalid ORG range**

The end address must be greater than or equal to the start address. The range may not overlap another range. The range may not include locations 0-3. If only one address is specified it must match the start address of a previous #org.

### **Invalid overload function**

**Invalid type conversion**

**Label not permitted here**

**Library in USE not found**

The identifier after the USE is not one of the pre-defined libraries for the compiler. Check the spelling.

Linker Error: "%s" already defined in "%s"

Linker Error: ("%s'

Linker Error: Cannot allocate memory for the section "%s" in the module "%s", because it overlaps with other sections.

Linker Error: Cannot find unique match for symbol "%s"

Linker Error: Cannot open file "%s"

Linker Error: COFF file "%s" is corrupt; recompile module.

Linker Error: Not enough memory in the target to reallocate the section "%s" in the module "%s".

Linker Error: Section "%s" is found in the modules "%s" and "%s" with different section types.

Linker Error: Unknown error, contact CCS support.

Linker Error: Unresolved external symbol "%s" inside the module "%s".

## TEST PCD

Linker option no compatible with prior options.

Linker Warning: Section "%s" in module "%s" is declared as shared but there is no shared memory in the target chip. The shared flag is ignored.

Linker option not compatible with prior options

Conflicting linker options are specified. For example using both the EXCEPT= and ONLY= options in the same directive is not legal.

LVALUE required

This error will occur when a constant is used where a variable should be. For example 4=5; will give this error.

Macro identifier requires parameters

A #DEFINE identifier is being used but no parameters were specified, as required. For example:

```
#define min(x,y) ((x<y)?x:y)
```

When called MIN must have a (--,--) after it such as:

```
r=min(value, 6);
```

Macro is defined recursively

A C macro has been defined in such a way as to cause a recursive call to itself.

Missing #ENDIF

A #IF was found without a corresponding #ENDIF.

Missing or invalid .CRG file

The user registration file(s) are not part of the download software. In order for the software to run the files must be in the same directory as the .EXE files. These files are on the original diskette, CD ROM or e-mail in a non-compressed format. You need only copy them to the .EXE directory.

There is one .REG file for each compiler (PCB.REG, PCM.REG and PCH.REG).

### More info:

#### Must have a #USE DELAY before this #USE

Must have a #USE DELAY before a #USE RS232

The RS232 library uses the DELAY library. You must have a #USE DELAY before you can do a #USE RS232.

No errors

The program has successfully compiled and all requested output files have been created.

No MAIN() function found

All programs are required to have one function with the name main().

### No overload function matches

#### No valid assignment made to function pointer

Not enough RAM for all variables

The program requires more RAM than is available. The symbol map shows variables allocated.

The call tree shows the RAM used by each function. Additional RAM usage can be obtained by breaking larger functions into smaller ones and splitting the RAM between them.

For example, a function A may perform a series of operations and have 20 local variables declared.

Upon analysis, it may be determined that there are two main parts to the calculations and many variables are not shared between the parts. A function B may be defined with 7 local variables and a function C may be defined with 7 local variables. Function A now calls B and C and combines the results and now may only need 6 variables. The savings are accomplished because B and C are not executing at the same time and the same real memory locations will be used for their 6



variables (just not at the same time). The compiler will allocate only 13 locations for the group of functions A, B, C where 20 were required before to perform the same operation.

Number of bits is out of range

For a count of bits, such as in a structure definition, this must be 1-8. For a bit number specification, such as in the #BIT, the number must be 0-7.

**Only integers are supported for this operation**

**Option invalid**

Out of ROM, A segment or the program is too large

A function and all of the INLINE functions it calls must fit into one segment (a hardware code page).

For example, on the PIC16 chip a code page is 512 instructions. If a program has only one function and that function is 600 instructions long, you will get this error even though the chip has plenty of ROM left. The function needs to be split into at least two smaller functions. Even after this is done, this error may occur since the new function may be only called once and the linker might automatically INLINE it. This is easily determined by reviewing the call tree. If this error is caused by too many functions being automatically INLINED by the linker, simply add a #SEPARATE before a function to force the function to be SEPARATE. Separate functions can be allocated on any page that has room. The best way to understand the cause of this error is to review the call tree.

**Parameters must be located in RAM**

Parameters not permitted

An identifier that is not a function or preprocessor macro can not have a ' ( ' after it.

Pointers to bits are not permitted

Addresses cannot be created to bits. For example, &X is not permitted if X is a SHORT INT.

Previous identifier must be a pointer

A -> may only be used after a pointer to a structure. It cannot be used on a structure itself or other kind of variable.

Printf format type is invalid

An unknown character is after the % in a printf. Check the printf reference for valid formats.

Printf format (%) invalid

A bad format combination was used. For example, %lc.

Printf variable count (%) does not match actual count

The number of % format indicators in the printf does not match the actual number of variables that follow. Remember in order to print a single %, you must use %%.

Recursion not permitted

The linker will not allow recursive function calls. A function may not call itself and it may not call any other function that will eventually re-call it.

Recursively defined structures not permitted

A structure may not contain an instance of itself.

Reference arrays are not permitted

A reference parameter may not refer to an array.

Return not allowed in void function

A return statement may not have a value if the function is void.

**RTOS call only allowed inside task functions**

**Selected part does not have ICD debug capability**

## TEST PCD

STDOUT not defined (may be missing #RS 232)

An attempt was made to use a I/O function such as printf when no default I/O stream has been established. Add a #USE RS232 to define a I/O stream.

Stream must be a constant in the valid range

I/O functions like fputc, fgetc require a stream identifier that was defined in a #USE RS232. This identifier must appear exactly as it does when it was defined. Be sure it has not been redefined with a #define.

String too long

Structure field name required

A structure is being used in a place where a field of the structure must appear. Change to the form s.f where s is the structure name and f is a field name.

Structures and UNIONS cannot be parameters (use \* or &)

A structure may not be passed by value. Pass a pointer to the structure using &.

Subscript out of range

A subscript to a RAM array must be at least 1 and not more than 128 elements. Note that large arrays might not fit in a bank. ROM arrays may not occupy more than 256 locations.

This linker function is not available in this compiler version.

Some linker functions are only available if the PCW or PCWH product is installed.

This type cannot be qualified with this qualifier

Check the qualifiers. Be sure to look on previous lines. An example of this error is:

```
VOID X;
```

Too many array subscripts

Arrays are limited to 5 dimensions.

Too many constant structures to fit into available space

Available space depends on the chip. Some chips only allow constant structures in certain places.

Look at the last calling tree to evaluate space usage. Constant structures will appear as functions with a @CONST at the beginning of the name.

Too many elements in an ENUM

A max of 256 elements are allowed in an ENUM.

### **Too many fast interrupt handlers have been defined**

Too many fast interrupt handlers have been identified

Too many nested #INCLUDEs

No more than 10 include files may be open at a time.

Too many parameters

More parameters have been given to a function than the function was defined with.

Too many subscripts

More subscripts have been given to an array than the array was defined with.

Type is not defined

The specified type is used but not defined in the program. Check the spelling.

Type specification not valid for a function

This function has a type specifier that is not meaningful to a function.

### **Undefined identifier**

Undefined label that was used in a GOTO

There was a GOTO LABEL but LABEL was never encountered within the required scope. A GOTO cannot jump outside a function.

Unknown device type

A #DEVICE contained an unknown device. The center letters of a device are always C regardless of the actual part in use. For example, use PIC16C74 not PIC16RC74. Be sure the correct compiler is being used for the indicated device. See #DEVICE for more information.

Unknown keyword in #FUSES

Check the keyword spelling against the description under #FUSES.

Unknown linker keyword

The keyword used in a linker directive is not understood.

Unknown type

The specified type is used but not defined in the program. Check the spelling.

**User aborted compilation**

USE parameter invalid

One of the parameters to a USE library is not valid for the current environment.

USE parameter value is out of range

One of the values for a parameter to the USE library is not valid for the current environment.

**Variable never used**

**Variable of this data type is never greater than this constant**



# COMPILER WARNING MESSAGES



C Compiler

## Compiler Warning Messages

#error/warning

Assignment inside relational expression

Although legal it is a common error to do something like `if(a=b)` when it was intended to do `if(a==b)`.

### Assignment to enum is not of the correct type.

This warning indicates there may be such a typo in this line:

Assignment to enum is not of the correct type

If a variable is declared as a ENUM it is best to assign to the variables only elements of the enum.

For example:

```
enum colors {RED, GREEN, BLUE} color;
...
color = GREEN; // OK
color = 1; // Warning 209
color = (colors)1; //OK
```

Code has no effect

The compiler can not discern any effect this source code could have on the generated code. Some examples:

```
1;
a==b;
1,2,3;
```

Condition always FALSE

This error when it has been determined at compile time that a relational expression will never be true. For example:

```
int x;
if( x>>9 )
```

Condition always TRUE

This error when it has been determined at compile time that a relational expression will never be false. For example:

```
#define PIN_A1 41
...
if( PIN_A1 ) // Intended was: if( input(PIN_A1) )
```

Function not void and does not return a value

Functions that are declared as returning a value should have a return statement with a value to be returned. Be aware that in C only functions declared VOID are not intended to return a value. If nothing is specified as a function return value "int" is assumed.

Duplicate #define

## TEST PCD

The identifier in the #define has already been used in a previous #define. To redefine an identifier use #UNDEF first. To prevent defines that may be included from multiple source do something like:

```
#ifndef ID
#define ID text
#endif
```

### Feature not supported

### Function never called

### Function not void and does not return a value.

### Info:

### Interrupt level changed

#### Interrupts disabled during call to prevent re-entrancy.

Linker Warning: "%s" already defined in object "%s"; second definition ignored.

Linker Warning: Address and size of section "%s" in module "%s" exceeds maximum range for this processor. The section will be ignored.

Linker Warning: The module "%s" doesn't have a valid chip id. The module will be considered for the target chip "%s".

Linker Warning: The target chip "%s" of the imported module "%s" doesn't match the target chip "%s" of the source.

Linker Warning: Unsupported relocation type in module "%s".

#### Memory not available at requested location.

Operator precedence rules may not be as intended, use() to clarify

Some combinations of operators are confusing to some programmers. This warning is issued for expressions where adding() would help to clarify the meaning. For example:

```
if( x << n + 1 )
```

would be more universally understood when expressed:

```
if( x << (n + 1) )
```

Option may be wrong

Structure passed by value

Structures are usually passed by reference to a function. This warning is generated if the structure is being passed by value. This warning is not generated if the structure is less than 5 bytes. For example:

```
void myfunct( mystruct s1 ) // Pass by value - Warning
myfunct( s2 );
void myfunct( mystruct * s1 ) // Pass by reference - OK
myfunct( &s2 );
void myfunct( mystruct & s1 ) // Pass by reference - OK
myfunct( s2 );
```

#### Undefined identifier

The specified identifier is being used but has never been defined. Check the spelling.

#### Unprotected call in a #INT\_GLOBAL

The interrupt function defined as #INT\_GLOBAL is intended to be assembly language or very simple C code. This error indicates the linker detected code that violated the standard memory

allocation scheme. This may be caused when a C function is called from a #INT\_GLOBAL interrupt handler.

**Unreachable code**

Code included in the program is never executed. For example:

```
if(n==5)
    goto do5;
goto exit;
if(n==20) // No way to get to this line
    return;
```

**Unsigned variable is never less than zero**

Unsigned variables are never less than 0. This warning indicates an attempt to check to see if an unsigned variable is negative. For example the following will not work as intended:

```
int i;
for(i=10; i>=0; i--)
```

**Variable assignment never used.**

Variable of this data type is never greater than this constant

A variable is being compared to a constant. The maximum value of the variable could never be larger than the constant. For example the following could never be true:

```
int x; // 8 bits, 0-255
if ( x>300)
```

**Variable never used**

A variable has been declared and never referenced in the code.

**Variable used before assignment is made.**





# COMMON QUESTIONS AND ANSWERS



## How are type conversions handled?

The compiler provides automatic type conversions when an assignment is performed. Some information may be lost if the destination can not properly represent the source. For example: `int8var = int16var;` Causes the top byte of `int16var` to be lost.

Assigning a smaller signed expression to a larger signed variable will result in the sign being maintained. For example, a signed 8 bit int that is -1 when assigned to a 16 bit signed variable is still -1.

Signed numbers that are negative when assigned to a unsigned number will cause the 2's complement value to be assigned. For example, assigning -1 to a `int8` will result in the `int8` being 255. In this case the sign bit is not extended (conversion to unsigned is done before conversion to more bits). This means the -1 assigned to a 16 bit unsigned is still 255.

Likewise assigning a large unsigned number to a signed variable of the same size or smaller will result in the value being distorted. For example, assigning 255 to a signed `int8` will result in -1.

The above assignment rules also apply to parameters passed to functions.

When a binary operator has operands of differing types then the lower order operand is converted (using the above rules) to the higher. The order is as follows:

- Float
- Signed 32 bit
- Unsigned 32 bit
- Signed 16 bit
- Unsigned 16 bit
- Signed 8 bit
- Unsigned 8 bit
- 1 bit

The result is then the same as the operands. Each operator in an expression is evaluated independently. For example:

```
i32 = i16 - (i8 + i8)
```

The + operator is 8 bit, the result is converted to 16 bit after the addition and the - is 16 bit, that result is converted to 32 bit and the assignment is done. Note that if `i8` is 200 and `i16` is 400 then the result in `i32` is 256. (200 plus 200 is 144 with a 8 bit +)

## TEST PCD

Explicit conversion may be done at any point with (type) inserted before the expression to be converted. For example in the above the perhaps desired effect may be achieved by doing:

```
i32 = i16 - ((long)i8 + i8)
```

In this case the first i8 is converted to 16 bit, then the add is a 16 bit add and the second i8 is forced to 16 bit.

A common C programming error is to do something like:

```
i16 = i8 * 100;
```

When the intent was:

```
i16 = (long) i8 * 100;
```

Remember that with unsigned ints (the default for this compiler) the values are never negative. For example 2-4 is 254 (in 8 bit). This means the following is an endless loop since i is never less than 0:

```
int i;  
for( i=100; i>=0; i--)
```

## How can a constant data table be placed in ROM?

The compiler has support for placing any data structure into the device ROM as a constant read-only element. Since the ROM and RAM data paths are separate, there are restrictions on how the data is accessed. For example, to place a 10 element BYTE array in ROM use:

```
BYTE CONST TABLE [10]= {9,8,7,6,5,4,3,2,1,0};
```

and to access the table use:

```
x = TABLE [i];
```

OR

```
x = TABLE [5];
```

### **BUT NOT**

```
ptr = &TABLE [i];
```

In this case, a pointer to the table cannot be constructed.

Similar constructs using CONST may be used with any data type including structures, longs and floats.

The following are two methods provided:

1. Efficient access with "const".

310

## 2. Pointer friendly "ROM" Qualifier, for example:

```
ROM BYTE TABLE[10] = {9,8,7,6,5,4,3,2,1,0}
and to access the table use:
    x = TABLE[i];
    or
    PTR = &TABLE[i];
    and
    x = *PTR;
//Be sure not to mix RAM and ROM pointers.  They are not
interchangeable.
```

## How can I use two or more RS-232 ports on one PIC®?

The #USE RS232 (and I2C for that matter) is in effect for GETC, PUTC, PRINTF and KBHIT functions encountered until another #USE RS232 is found.

The #USE RS232 is not an executable line. It works much like a #DEFINE.

The following is an example program to read from one RS-232 port (A) and echo the data to both the first RS-232 port (A) and a second RS-232 port (B).

```
#USE RS232(BAUD=9600, XMIT=PIN_B0, RCV=PIN_B1)
void put_to_a( char c ) {
    put(c);
}
char get_from_a( ) {
    return(getc()); }
#USE RS232(BAUD=9600, XMIT=PIN_B2,RCV=PIN_B3)
void put_to_b( char b ) {
    putc(c);
}
main() {
    char c;
    put_to_a("Online\n\r");
    put_to_b("Online\n\r");
    while(TRUE) {
        c=get_from_a();
        put_to_b(c);
        put_to_a(c);
    }
}
```

The following will do the same thing but is more readable and is the recommended method:

```
#USE RS232(BAUD=9600, XMIT=PIN_B0, RCV=PIN_B1, STREAM=COM_A)
#USE RS232(BAUD=9600, XMIT=PIN_B2, RCV=PIN_B3, STREAM=COM_B)
```

```

main() {
    char c;
    fprintf(COM_A, "Online\n\r");
    fprintf(COM_B, "Online\n\r");
    while(TRUE) {
        c = fgetc(COM_A);
        fputc(c, COM_A);
        fputc(c, COM_B);
    }
}

```

## How do I directly read/write to internal registers?

A hardware register may be mapped to a C variable to allow direct read and write capability to the register. The following is an example using the TIMER0 register:

```

#BYTE timer 1 = 0x 100
timer0= 128; //set timer0 to 128
while (timer 1 != 200); // wait for timer0 to reach 200

```

Bits in registers may also be mapped as follows:

```

#BIT T 1 IF = 0x 84.3
.
.
.
while (!T 1 IF); //wait for timer0 interrupt

```

Registers may be indirectly addressed as shown in the following example:

```

printf ("enter address:");
a = gethex ();
printf ("\r\n value is %x\r\n", *a);

```

The compiler has a large set of built-in functions that will allow one to perform the most common tasks with C function calls. When possible, it is best to use the built-in functions rather than directly write to registers. Register locations change between chips and some register operations require a specific algorithm to be performed when a register value is changed. The compiler also takes into account known chip errata in the implementation of the built-in functions. For example, it is better to do `set_tris_B (0)`; rather than `*0x 02C6 =0`;

## How do I do a printf to a string?

---

The following is an example of how to direct the output of a printf to a string. We used the lf to indicate the start of the string.

This example shows how to put a floating point number in a string.

```
main() {
    char string[20];
    float f;
    f=12.345;
    sprintf(string, "\f%6.3f", f);
}
```

## How do I get getc() to timeout after a specified time?

GETC will always wait for a character to become available unless a timeout time is specified in the #use rs232().

The following is an example of how to setup the PIC to timeout when waiting for an RS232 character.

```
#include <18F4520.h>
#fuses HS,NOWDT
#use delay(clock=20MHz)
#use rs232(UART1,baud=9600,timeout=500) //timeout = 500 milliseconds, 1/2
second
void main()
{
    char c;

    while(TRUE)
    {
        c=getc(); //if getc() timeouts 0 is returned to c
                //otherwise receive character is returned to c

        if(c) //if not zero echo character back
            putc(c);
        //user to do code
        output_toggle(PIN_A5);
    }
}
```

## How do I make a pointer to a function?

The compiler does not permit pointers to functions so that the compiler can know at compile time the complete call tree. This is used to allocate memory for full RAM re-use. Functions that could not be in execution at the same time will use the same RAM locations. In addition since there is no data stack in the PIC®, function parameters are passed in a special way that requires knowledge at compile time of what function is being called. Calling a function via a pointer will prevent knowing both of these things at compile time. Users sometimes will want function pointers to create a state machine. The following is an example of how to do this without pointers:

```
enum tasks {taskA, taskB, taskC};
run_task(tasks task_to_run) {
    switch(task_to_run) {
        case taskA : taskA_main(); break;
        case taskB : taskB_main(); break;
        case taskC : taskC_main(); break;
    }
}
```

## How do I wait only a specified time for a button press?

The following is an example of how to wait only a specific time for a button press.

```
#define PUSH_BUTTON PIN_A4
int1 timeout_error;
int1 timed_get_button_press(void){
    int16 timeout;

    timeout_error=FALSE;
    timeout=0;
    while(input(PUSH_BUTTON) && (++timeout<50000)) // 1/2 second
        delay_us(10);
    if(!input(PUSH_BUTTON))
        return(TRUE); //button pressed
    else{
        timeout_error=TRUE;
        return(FALSE); //button not pressed timeout occurred
    }
}
```

## How do I write variables to EEPROM that are not a word?

The following is an example of how to read and write a floating point number from/to EEPROM. The same concept may be used for structures, arrays or any other types.

- n is an offset into the EEPROM

```
WRITE_FLOAT_EEPROM(int16 n, float data) {
    write_eeprom(n, data, sizeof(float));
}

float READ_FLOAT_EEPROM(int16 n) {
    float data;
    (int32)data = read_eeprom(n, sizeof(float));
    return(data);
}
```

## How does one map a variable to an I/O port?

Two methods are as follows:

```
#byte PORTB = 0x02C8 //Just an example, check the
#define ALL_OUT 0 //DATA sheet for the correct
#define ALL_IN 0xff //address for your chip
main() {
    int i;

    set_tris_b(ALL_OUT);
    PORTB = 0; // Set all pins low
    for(i=0; i<=127; ++i) // Quickly count from 0 to 127
        PORTB=i; // on the I/O port pin
    set_tris_b(ALL_IN);
    i = PORTB; // i now contains the portb value.
}
```

Remember when using the #BYTE, the created variable is treated like memory. You must maintain the tri-state control registers yourself via the SET\_TRIS\_X function. Following is an example of placing a structure on an I/O port:

```
struct port_b_layout
{int data : 4;
 int rw : 1;
 int cd : 1;

};
```

## TEST PCD

```
struct port_b_layout port_b;
#define port_b = 0x02C8
struct port_b_layout const INIT_1 = {0, 1,1, };
struct port_b_layout const INIT_2 = {3, 1,1, };
struct port_b_layout const INIT_3 = {0, 0,0, };
struct port_b_layout const FOR_SEND = {0,0,0, };
// All outputs
struct port_b_layout const FOR_READ = {15,0,0, };
// Data is an input

main() {
    int x;
    set_tris_b((int)FOR_SEND); // The constant
                                // structure is
                                // treated like
                                // a byte and
                                // is used to
                                // set the data
                                // direction

    port_b = INIT_1;
    delay_us(25);

    port_b = INIT_2; // These constant structures delay_us(25);
                    // are used to set all fields
    port_b = INIT_3; // on the port with a single
                    // command

    set_tris_b((int)FOR_READ);
    port_b.rw=0;
                                // Here the individual
    port_b.cd=1; // fields are accessed
                // independently.
    x = port_b.data;
}

```

## How does the compiler determine TRUE and FALSE on expressions?

When relational expressions are assigned to variables, the result is always 0 or 1.

For example:

```
bytevar = 5>0; //bytevar will be 1
bytevar = 0>5; //bytevar will be 0
```

The same is true when relational operators are used in expressions.

For example:



```
bytevar = (x>y)*4;
```

is the same as:

```
if( x>y )
    bytevar=4;
else
    bytevar=0;
```

SHORT INTs (bit variables) are treated the same as relational expressions. They evaluate to 0 or 1.

When expressions are converted to relational expressions or SHORT INTs, the result will be FALSE (or 0) when the expression is 0, otherwise the result is TRUE (or 1).

For example:

```
bytevar = 54;
bitvar = bytevar; //bitvar will be 1 (bytevar != 0)
if(bytevar) //will be TRUE
    bytevar = 0;
bitvar = bytevar; //bitvar will be 0
```

## How does the PIC® connect to a PC?

A level converter should be used to convert the TTL (0-5V) levels that the PIC® operates with to the RS-232 voltages (+/- 3-12V) used by the PIC®. The following is a popular configuration using the MAX232 chip as a level converter.

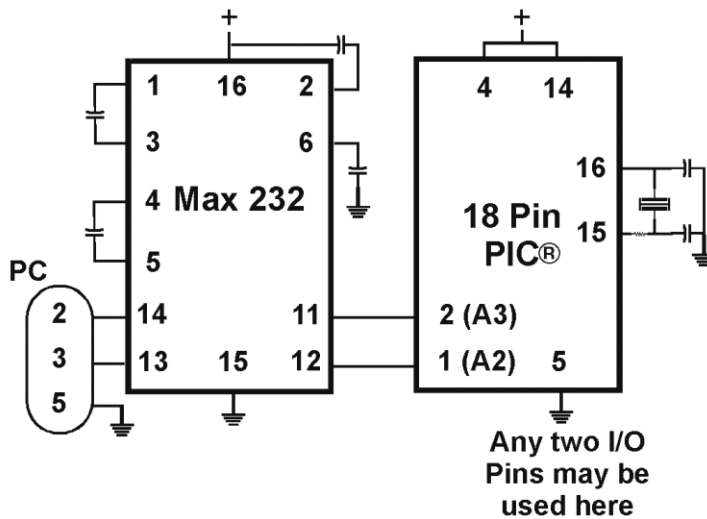

## How does the PIC® connect to an I2C device?

Two I/O lines are required for I2C. Both lines must have pullup registers. Often the I2C device will have a H/W selectable address. The address set must match the address in SW. The example programs all assume the selectable address lines are grounded.

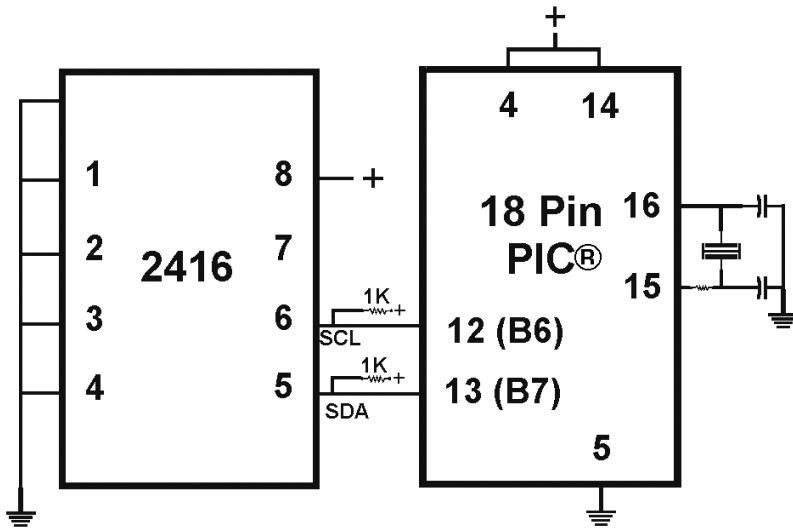

## How much time do math operations take?

Unsigned 8 bit operations are quite fast and floating point is very slow. If possible consider fixed point instead of floating point. For example instead of "float cost\_in\_dollars;" do "long cost\_in\_cents;". For trig formulas consider a lookup table instead of real time calculations (see EX\_SINE.C for an example). The following are some rough times on a 24-bit PIC®. Note times will vary depending on memory banks used.

### 80mhz dsPIC33FJ (40MIPS)

|       | int8<br>[us] | int16<br>[us] | int32<br>[us] | int48<br>[us] | int64<br>[us] | float32<br>[us] | float48<br>[us] | float 64<br>[us] |
|-------|--------------|---------------|---------------|---------------|---------------|-----------------|-----------------|------------------|
| +     | 0.075        | 0.75          | 0.175         | 0.275         | 0.375         | 3.450           | 3.825           | 5.025            |
| -     | 0.125        | 0.125         | 0.200         | 0.350         | 0.400         | 3.375           | 3.725           | 5.225            |
| *     | 0.175        | 0.100         | 1.150         | 1.850         | 1.975         | 2.450           | 2.950           | 4.525            |
| /     | 0.650        | 0.550         | 13.500        | 25.550        | 68.225        | 12.475          | 22.575          | 33.80            |
| exp() | *            | *             | *             | *             | *             | 70.675          | 158.55          | 206.125          |
| ln()  | *            | *             | *             | *             | *             | 94.475          | 157.400         | 201.825          |
| sin() | *            | *             | *             | *             | *             | 77.875          | 136.925         | 184.225          |

## What are the various Fuse options for the dsPIC/PIC 24 chips?

### DsPIC30F chips fuse Summary:

The oscillator settings for the dsPIC30F family are divided into 3 versions.

Version 1 is the basic version that is supported by all the chips.

Version 2 and Version 3 are additions and improvements to these oscillator settings.

### Version1 Chip Features:

Primary Oscillator with multiple clock modes – XT, EC, HS

Secondary Oscillator (Low Power 32 kHz)

FRC – Fast Internal RC 7.37 Mhz

LPRC Low Power Internal RC (512 kHz)

Version1 chips support following PLL Clock Multiplier settings

4x ,8x and 16x PLL mode for XT and EC only

Generic post-scaler (divide by 1,4,16,64)

## TEST PCD

Version2 Chip Features:  
PLL Options applicable for FRC Oscillator

Version3 Chip Features:  
PLL Options applicable for the HS Oscillator : Use HS2\_PLLx and HS3\_PLLx fuses

Version1 Chips:  
30F6010, 30F6012, 30F6013, 30F6014  
Sample Code for setting fuses for HS mode (Primary Oscillator)  
#fuses HS, PR, NOWDT  
#use delay(clock=20000000) // A 20 Mhz crystal is used

Sample Code for setting fuses for FRC Internal Oscillator mode  
#fuses FRC, NOWDT  
#use delay(clock=7370000) // Internal FRC clock of 7.37 Mhz is used

Version2 Chips:  
30F2010, 30F4011, 30F4012, 30F5011, 30F5013  
Note: The FRC\_PLLx options is added for this version, but this does not include the 30F2010 chip.

Sample Code for setting the fuse for HS mode (Primary Oscillator)  
#fuses HS, PR, NOWDT  
#use delay(clock=20000000) // A 20 Mhz crystal is used

Sample Code for setting fuses for FRC Internal Oscillator mode  
#fuses FRC, NOWDT  
#use delay(clock=7370000) // Internal FRC clock of 7.37 Mhz is used

Sample Code for setting fuses for FRC Internal Oscillator mode with PLL enabled  
#fuses PR, FRC\_PLL8, NOWDT  
#use delay(clock=58960000) // Internal FRC clock of  $7.37 * 8 = 58.96$  Mhz is used

Version3 Chips:  
30F2011, 30F2012, 30F3010, 30F3011, 30F3012, 30F3013, 30F3014, 30F4013, 30F5015,  
30F5016, 30F6010A, 30F6011A, 30F6012A, 30F6013A, 30F6014A, 30F6015

Sample Code for setting the fuse for HS mode (Primary Oscillator)  
#fuses HS, PR, NOWDT  
#use delay(clock=20000000) // A 20 Mhz crystal is used

Sample Code for setting fuses for FRC Internal Oscillator mode  
#fuses FRC, NOWDT  
#use delay(clock=7370000) // Internal FRC clock of 7.37 Mhz is used

Sample Code for setting fuses for FRC Internal Oscillator mode with PLL enabled  
#fuses FRC\_PLL16, PR\_PLL, NOWDT  
#use delay(clock=117920000) // Internal FRC clock of  $7.37 * 16 = 117.92$  Mhz is used

Sample Code for setting fuse for HS mode using PLL options. The following PLL options are applicable for the HS fuse:

HS2\_PLLx : Divide by 2, x times PLL enabled.  
HS3\_PLLx : Divide by 3, x times PLL enabled.

```
#fuses HS2_PLL8, PR_PLL, NOWDT  
#use delay(clock=2000000) // A 20 Mhz crystal is used
```

The **30F2020** , **30F1010** and **30F2023** chips are quite different from the other 30F chips. One major difference is that the Instruction clock is divide by 2 of the actual input clock. The other chips in the family use a divide by 4.

Crystal Frequency Limitations for various fuses:

HS Mode 10 – 25 MHz  
XT Mode 4 – 10 MHz  
EC Mode 4 – 10 Mhz

Note: The upper limits of these crystal setting will change when the PLL fuses are used. (For example HS2\_PLL16, EC\_PLL16). At no point should the system clock exceed 120 MHz after the PLL block. The instruction clock for the 30F chips is derived by dividing this final clock by 4. So, the maximum clock rate for the 30F chips is 30 MHz.

## What can be done about an OUT OF RAM error?

The compiler makes every effort to optimize usage of RAM. Understanding the RAM allocation can be a help in designing the program structure. The best re-use of RAM is accomplished when local variables are used with lots of functions. RAM is re-used between functions not active at the same time. See the NOT ENOUGH RAM error message in this manual for a more detailed example.

RAM is also used for expression evaluation when the expression is complex. The more complex the expression, the more scratch RAM locations the compiler will need to allocate to that expression. The RAM allocated is reserved during the execution of the entire function but may be re-used between expressions within the function. The total RAM required for a function is the sum of the parameters, the local variables and the largest number of scratch locations required for any expression within the function. The RAM required for a function is shown in the call tree after the RAM=. The RAM stays used when the function calls another function and new RAM is allocated for the new function. However when a function RETURNS the RAM may be re-used by another function called by the parent. Sequential calls to functions each with their own local variables is very efficient use of RAM as opposed to a large function with local variables declared for the entire process at once.

Be sure to use SHORT INT (1 bit) variables whenever possible for flags and other boolean variables. The compiler can pack eight such variables into one byte location. The compiler does this automatically whenever you use SHORT INT. The code size and ROM size will be smaller.

Finally, consider an external memory device to hold data not required frequently. An external 8 pin EEPROM or SRAM can be connected to the PIC® with just 2 wires and provide a great deal of additional storage capability. The compiler package includes example drivers for these devices. The primary drawback is a slower access time to read and write the data. The SRAM will have fast read and write with memory being lost when power fails. The EEPROM will have a very long write cycle, but can retain the data when power is lost.

## What is an easy way for two or more PICs® to communicate?

There are two example programs (EX\_PBUSM.C and EX\_PBUSR.C) that show how to use a simple one-wire interface to transfer data between PICs®. Slower data can use pin B0 and the EXT interrupt. The built-in UART may be used for high speed transfers. An RS232 driver chip may be used for long distance operations. The RS485 as well as the high speed UART require 2 pins and minor software changes. The following are some hardware configurations.

### SIMPLE MULTIPLE PIC® BUS

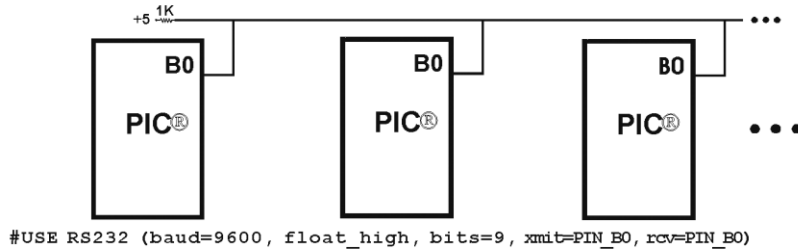

### LONG DISTANCE MUTLI-DROP BUS

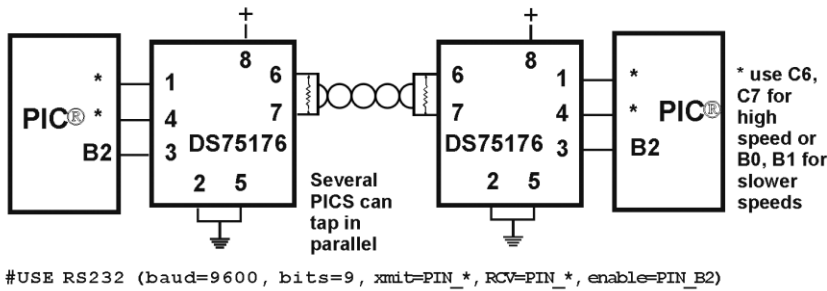

## What is an easy way for two or more PICs® to communicate?

There are two example programs (EX\_PBUSM.C and EX\_PBUSR.C) that show how to use a simple one-wire interface to transfer data between PICs®. Slower data can use pin B0 and the EXT interrupt. The built-in UART may be used for high speed transfers. An RS232 driver chip may be used for long distance operations. The RS485 as well as the high speed UART require 2 pins and minor software changes. The following are some hardware configurations.

### SIMPLE MULTIPLE PIC® BUS

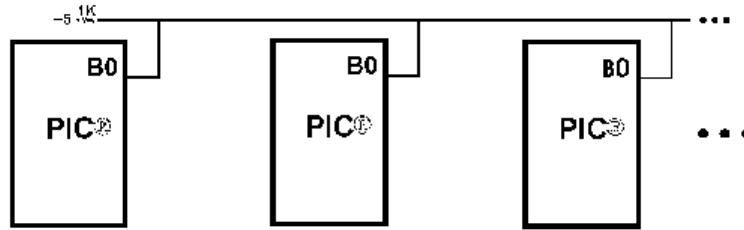

```
#USE RS232 (baud=9600, float_high, bits=9, xmit=PIN_B0, rcv=PIN_B0)
```

### LONG DISTANCE MUTLI-DROP BUS

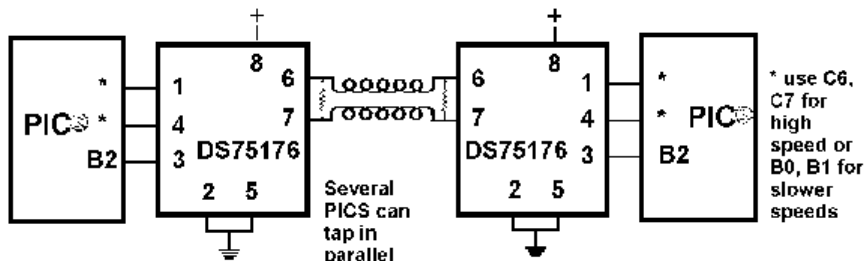

```
#USE RS232 (baud=9600, bits=9, xmit=PIN_*, rcv=PIN_*, enable=PIN_B2)
```

## What is the format of floating point numbers?

The CCS PCD compiler uses the IEEE format for all the floating point number operations. The following floating point numbers are supported:

- 32 bit floating point numbers – Single Precision
- 48 bit floating point numbers – Extended Precision
- 64 bit floating point numbers – Double Precision

TEST PCD

The format of these numbers is as follows:

32 bit floating point numbers – Single Precision

|      |          |    |          |          |
|------|----------|----|----------|----------|
| Sign | Exponent | Ex | Mantissa | Mantissa |
| 31   | 30       | 23 | 22       | 15 0     |

- 23 bit Mantissa (Bit 0 – Bit 22)
- 8 bit exponent (Bit 23 – bit 30)
- 1 sign bit (Bit 31)

**Example Numbers**

Representation  
Hex - 32 bit float

|            |      |      |
|------------|------|------|
| 0          | 0000 | 0000 |
| 1          | 3F80 | 0000 |
| -1         | BF80 | 0000 |
| 10         | 4120 | 0000 |
| 100        | 42C8 | 0000 |
| 123.45     | 42F6 | E666 |
| 123.45E20  | 6427 | 4E53 |
| 213.45E-20 | 21B6 | 2E17 |

31 15 0

48 bit floating point numbers –Extended Precision

|      |          |          |          |          |
|------|----------|----------|----------|----------|
| Sign | Exponent | Mantissa | Mantissa | Mantissa |
| 47   | 46 39    | 38 32    | 31 16    | 15 0     |

- 1 Sign bit – (Bit 47)
- 8 bit Exponent (Bits 39 – 46)
- 39 bit Mantissa (Bit 0 – bit 39)

**Example Numbers**

Representation Hex - 64 bit float

|            |      |      |      |
|------------|------|------|------|
| 1          | 3F80 | 0000 | 0000 |
| -1         | BF80 | 0000 | 0000 |
| 10         | 4120 | 0000 | 0000 |
| 100        | 42C8 | 0000 | 0000 |
| 123.45     | 42F6 | E666 | 6666 |
| 123.45E20  | 6427 | 4E52 | 9759 |
| 213.45E-20 | 21B6 | 2E17 | 64FF |

47 31 15 0



64 bit floating point numbers – Double Precision

|      |          |          |          |          |
|------|----------|----------|----------|----------|
| Sign | Exponent | Mantissa | Mantissa | Mantissa |
| 63   | 62 52    | 51 32    | 31 16    | 15 0     |

- 1 Sign bit – (Bit 47)
- 11 bit Exponent (Bits 52 – 62)
- 52 bit Mantissa (Bit 0 – bit 51)

**Example Numbers** Representation Hex - 64 bit float

|            |      |      |      |      |
|------------|------|------|------|------|
| 0          | 0000 | 0000 | 0000 | 0000 |
| 1          | 3FF0 | 0000 | 0000 | 0000 |
| -1         | BFF0 | 0000 | 0000 | 0000 |
| 10         | 4024 | 0000 | 0000 | 0000 |
| 100        | 4059 | 0000 | 0000 | 0000 |
| 123.45     | 405E | DCCC | CCCC | CCCC |
| 123.45E20  | 4484 | E9CA | 52EB | 182A |
| 213.45E-20 | 3C36 | C5C2 | EC9F | DBFD |
|            | 63   | 47   | 31   | 15 0 |

## Why does the .LST file look out of order?

The list file is produced to show the assembly code created for the C source code. Each C source line has the corresponding assembly lines under it to show the compiler's work. The following three special cases make the .LST file look strange to the first time viewer. Understanding how the compiler is working in these special cases will make the .LST file appear quite normal and very useful.

1. Stray code near the top of the program is sometimes under what looks like a non-executable source line.

Some of the code generated by the compiler does not correspond to any particular source line. The compiler will put this code either near the top of the program or sometimes under a #USE that caused subroutines to be generated.

2. The addresses are out of order.

The compiler will create the .LST file in the order of the C source code. The linker has re-arranged the code to properly fit the functions into the best code pages and the best half of a code page. The resulting code is not in source order. Whenever the compiler has a discontinuity in the .LST file, it

## TEST PCD

will put a \* line in the file. This is most often seen between functions and in places where INLINE functions are called. In the case of an INLINE function, the addresses will continue in order up where the source for the INLINE function is located.

3. The compiler has gone insane and generated the same instruction over and over.

For example:

```
.....A=0;
03F:      CLRF  15
*
46:CLRF  15
*
051:      CLRF  15
*
113:      CLRF  15
```

This effect is seen when the function is an INLINE function and is called from more than one place. In the above case, the A=0 line is in an INLINE function called in four places. Each place it is called from gets a new copy of the code. Each instance of the code is shown along with the original source line, and the result may look unusual until the addresses and the \* are noticed.

## Why is the RS-232 not working right?

1. The PIC® is Sending Garbage Characters.
  - A. Check the clock on the target for accuracy. Crystals are usually not a problem but RC oscillators can cause trouble with RS-232. Make sure the #USE DELAY matches the actual clock frequency.
  - B. Make sure the PC (or other host) has the correct baud and parity setting.
  - C. Check the level conversion. When using a driver/receiver chip, such as the MAX 232, do not use INVERT when making direct connections with resistors and/or diodes. You probably need the INVERT option in the #USE RS232.
  - D. Remember that PUTC(6) will send an ASCII 6 to the PC and this may not be a visible character. PUTC('A') will output a visible character A.
2. The PIC® is Receiving Garbage Characters.
  - A. Check all of the above.
3. Nothing is Being Sent.
  - A. Make sure that the tri-state registers are correct. The mode (standard, fast, fixed) used will be whatever the mode is when the #USE RS232 is encountered. Staying with the default STANDARD mode is safest.
  - B. Use the following main() for testing:

```
main() {
    while(TRUE)
        putc('U');
}
```

Check the XMIT pin for activity with a logic probe, scope or whatever you can. If you can look at it with a scope, check the bit time (it should be 1/BAUD). Check again after the level converter.

4. Nothing is being received.

First be sure the PIC® can send data. Use the following main() for testing:

```
main() {
    printf("start");
    while(TRUE)
        putc( getc()+1 );
}
```

When connected to a PC typing A should show B echoed back.

If nothing is seen coming back (except the initial "Start"), check the RCV pin on the PIC® with a logic probe. You should see a HIGH state and when a key is pressed at the PC, a pulse to low. Trace back to find out where it is lost.

5. The PIC® is always receiving data via RS-232 even when none is being sent.

A. Check that the INVERT option in the USE RS232 is right for your level converter. If the RCV pin is HIGH when no data is being sent, you should NOT use INVERT. If the pin is low when no data is being sent, you need to use INVERT.

B. Check that the pin is stable at HIGH or LOW in accordance with A above when no data is being sent.

C. When using PORT A with a device that supports the SETUP\_ADC\_PORTS function make sure the port is set to digital inputs. This is not the default. The same is true for devices with a comparator on PORT A.

6. Compiler reports INVALID BAUD RATE.

A. When using a software RS232 (no built-in UART), the clock cannot be really slow when fast baud rates are used and cannot be really fast with slow baud rates. Experiment with the clock/baud rate values to find your limits.

B. When using the built-in UART, the requested baud rate must be within 3% of a rate that can be achieved for no error to occur. Some parts have internal bugs with BRGH set to 1 and the compiler will not use this unless you specify BRGH1OK in the #USE RS232 directive.



# EXAMPLE PROGRAMS



C Compiler

## EXAMPLE PROGRAMS

A large number of example programs are included with the software. The following is a list of many of the programs and some of the key programs are re-printed on the following pages. Most programs will work with any chip by just changing the #INCLUDE line that includes the device information. All of the following programs have wiring instructions at the beginning of the code in a comment header. The SLOW.EXE program included in the program directory may be used to demonstrate the example programs. This program will use a PC COM port to communicate with the target.

Generic header files are included for the standard PIC® parts. These files are in the DEVICES directory. The pins of the chip are defined in these files in the form PIN\_B2. It is recommended that for a given project, the file is copied to a project header file and the PIN\_xx defines be changed to match the actual hardware. For example; LCDRW (matching the mnemonic on the schematic). Use the generic include files by placing the following in your main .C file:

```
#include <16C74.H>
```

### LIST OF COMPLETE EXAMPLE PROGRAMS (in the EXAMPLES directory)

#### **EX\_1920.C**

Uses a Dallas DS1920 button to read temperature

#### **EX\_AD12.C**

Shows how to use an external 12 bit A/D converter

#### **EX\_ADMM.C**

A/D Conversion example showing min and max analog readings

#### **EX\_ADMM10.C**

Similar to ex\_admm.c, but this uses 10bit A/D readings.

#### **EX\_ADMM\_STATS.C**

Similar to ex\_admm.c, but this uses also calculates the mean and standard deviation.

#### **EX\_BOOTLOAD.C**

A stand-alone application that needs to be loaded by a bootloader (see ex\_bootloader.c for a bootloader).

#### **EX\_BOOTLOADER.C**

A bootloader, loads an application onto the PIC (see ex\_bootload.c for an application).

TEST PCD

**EX\_CAN.C**

Receive and transmit CAN packets.

**EX\_CHECKSUM.C**

Determines the checksum of the program memory, verifies it against the checksum that was written to the USER ID location of the PIC.

**EX\_COMP.C**

Uses the analog comparator and voltage reference available on some PIC 24 s

**EX\_CRC.C**

Calculates CRC on a message showing the fast and powerful bit operations

**EX\_CUST.C**

Change the nature of the compiler using special preprocessor directives

**EX\_FIXED.C**

Shows fixed point numbers

**EX\_DPOT.C**

Controls an external digital POT

**EX\_DTMF.C**

Generates DTMF tones

**EX\_ENCOD.C**

Interfaces to an optical encoder to determine direction and speed

**EX\_EXPIO.C**

Uses simple logic chips to add I/O ports to the PIC

**EX\_EXSIO.C**

Shows how to use a multi-port external UART chip

**EX\_EXTEE.C**

Reads and writes to an external EEPROM

**EX\_EXTDYNMEM.C**

Uses addressmod to create a user defined storage space, where a new qualifier is created that reads/writes to an external RAM device.

**EX\_FAT.C**

An example of reading and writing to a FAT file system on an MMC/SD card.

**EX\_FLOAT.C**

Shows how to use basic floating point

**EX\_FREQ.C**

A 50 mhz frequency counter

330

**EX\_GLCD.C**

Displays contents on a graphic LCD, includes shapes and text.

**EX\_GLINT.C**

Shows how to define a custom global interrupt handler for fast interrupts

**EX\_HUMIDITY.C**

How to read the humidity from a Humirel HT3223/HTF3223 Humidity module

**EX\_ICD.C**

Shows a simple program for use with Microchips ICD debugger

**EX\_INPUTCAPTURE.C**

Uses the PIC input capture module to measure a pulse width

**EX\_INTEE.C**

Reads and writes to the PIC internal EEPROM

**EX\_LCDKB.C**

Displays data to an LCD module and reads data for keypad

**EX\_LCDTH.C**

Shows current, min and max temperature on an LCD

**EX\_LED.C**

Drives a two digit 7 segment LED

**EX\_LOAD.C**

Serial boot loader program

**EX\_LOGGER.C**

A simple temperature data logger, uses the flash program memory for saving data

**EX\_MACRO.C**

Shows how powerful advanced macros can be in C

**EX\_MALLOC.C**

An example of dynamic memory allocation using malloc().

**EX\_MCR.C**

An example of reading magnetic card readers.

**EX\_MMCS.D.C**

An example of using an MMC/SD media card as an external EEPROM. To use this card with a FAT file system, see ex\_fat.c

**EX\_MODBUS\_MASTER.C**

An example MODBUS application, this is a master and will talk to the ex\_modbus\_slave.c example.

TEST PCD

**EX\_MODBUS\_SLAVE.C**

An example MODBUS application, this is a slave and will talk to the ex\_modbus\_master.c example.

**EX\_MOUSE.C**

Shows how to implement a standard PC mouse on a PIC

**EX\_MXRAM.C**

Shows how to use all the RAM on parts with problem memory allocation

**EX\_OUTPUTCOMPARE.C**

Generates a precision pulse using the PIC output compare module.

**EX\_PATG.C**

Generates 8 square waves of different frequencies

**EX\_PBUSM.C**

Generic PIC to PIC message transfer program over one wire

**EX\_PBUSR.C**

Implements a PIC to PIC shared RAM over one wire

**EX\_PBUTT.C**

Shows how to use the B port change interrupt to detect pushbuttons

**EX\_PGEN.C**

Generates pulses with period and duty switch selectable

**EX\_PLL.C**

Interfaces to an external frequency synthesizer to tune a radio

**EX\_PSP.C**

Uses the PIC PSP to implement a printer parallel to serial converter

**EX\_PULSE.C**

Measures a pulse width using timer0

**EX\_PWM.C**

Uses the PIC output compare module to generate a PWM pulse stream.

**EX\_QSORT.C**

An example of using the stdlib function qsort() to sort data. Pointers to functions is used by qsort() so the user can specify their sort algorithm.

**EX\_REACT.C**

Times the reaction time of a relay closing using the input capture module.

**EX\_RFID.C**

An example of how to read the ID from a 125kHz RFID transponder tag.

332



**EX\_RMSDB.C**

Calculates the RMS voltage and dB level of an AC signal

**EX\_RS485.C**

An application that shows a multi-node communication protocol commonly found on RS-485 busses.

**EX\_RTC.C**

Sets and reads an external Real Time Clock using RS232

**EX\_RTCLK.C**

Sets and reads an external Real Time Clock using an LCD and keypad

**EX\_RTCTIMER.C**

How to use the PIC's hardware timer as a real time clock.

**EX\_RTOS\_DEMO\_X.C**

9 examples are provided that show how to use CCS's built-in RTOS (Real Time Operating System).

**EX\_SINE.C**

Generates a sine wave using a D/A converter

**EX\_SISR.C**

Shows how to do RS232 serial interrupts

**EX\_STISR.C**

Shows how to do RS232 transmit buffering with interrupts

**EX\_SLAVE.C**

Simulates an I2C serial EEPROM showing the PIC slave mode

**EX\_SPEED.C**

Calculates the speed of an external object like a model car

**EX\_SPI.C**

Communicates with a serial EEPROM using the H/W SPI module

**EX\_SPI\_SLAVE.C**

How to use the PIC's MSSP peripheral as a SPI slave. This example will talk to the ex\_spi.c example.

**EX\_SQW.C**

Simple Square wave generator

**EX\_SRAM.C**

Reads and writes to an external serial RAM

TEST PCD

**EX\_STEP.C**

Drives a stepper motor via RS232 commands and an analog input

**EX\_STR.C**

Shows how to use basic C string handling functions

**EX\_STWT.C**

A stop Watch program that shows how to user a timer interrupt

**EX\_SYNC\_MASTER.C**

**EX\_SYNC\_SLAVE.C**

An example of using the USART of the PIC in synchronous mode. The master and slave examples talk to each other.

**EX\_TANK.C**

Uses trig functions to calculate the liquid in a odd shaped tank

**EX\_TEMP.C**

Displays (via RS232) the temperature from a digital sensor

**EX\_TGETC.C**

Demonstrates how to timeout of waiting for RS232 data

**EX\_TONES.C**

Shows how to generate tones by playing "Happy Birthday"

**EX\_TOUCH.C**

Reads the serial number from a Dallas touch device

**EX\_USB\_HID.C**

Implements a USB HID device on the PIC16C765 or an external USB chip

**EX\_USB\_SCOPE.C**

Implements a USB bulk mode transfer for a simple oscilloscope on an external USB chip

**EX\_USB\_KBMOUSE.C**

**EX\_USB\_KBMOUSE2.C**

Examples of how to implement 2 USB HID devices on the same device, by combining a mouse and keyboard.

**EX\_USB\_SERIAL.C**

**EX\_USB\_SERIAL2.C**

Examples of using the CDC USB class to create a virtual COM port for backwards compatibility with legacy software.

**EX\_VOICE.C**

Self learning text to voice program

**EX\_WAKUP.C**

Shows how to put a chip into sleep mode and wake it up

**EX\_WDTDS.C**

Shows how to use the dsPIC30/dsPIC33/PIC24 watchdog timer

**EX\_X10.C**

Communicates with a TW523 unit to read and send power line X10 codes

**EX\_EXT.A.C**

The XTEA encryption cipher is used to create an encrypted link between two PICs.

**LIST OF INCLUDE FILES (in the DRIVERS directory)**

**2401.C**

Serial EEPROM functions

**2402.C**

Serial EEPROM functions

**2404.C**

Serial EEPROM functions

**2408.C**

Serial EEPROM functions

**24128.C**

Serial EEPROM functions

**2416.C**

Serial EEPROM functions

**24256.C**

Serial EEPROM functions

**2432.C**

Serial EEPROM functions

**2465.C**

Serial EEPROM functions

**25160.C**

Serial EEPROM functions

**25320.C**

Serial EEPROM functions

**25640.C**

Serial EEPROM functions

TEST PCD

**25C080.C**

Serial EEPROM functions

**68HC68R1**

C Serial RAM functions

**68HC68R2.C**

Serial RAM functions

**74165.C**

Expanded input functions

**74595.C**

Expanded output functions

**9346.C**

Serial EEPROM functions

**9356.C**

Serial EEPROM functions

**9356SPI.C**

Serial EEPROM functions (uses H/W SPI)

**9366.C**

Serial EEPROM functions

**AD7705.C**

A/D Converter functions

**AD7715.C**

A/D Converter functions

**AD8400.C**

Digital POT functions

**ADS8320.C**

A/D Converter functions

**ASSERT.H**

Standard C error reporting

**AT25256.C**

Serial EEPROM functions

**AT29C1024.C**

Flash drivers for an external memory chip

**CRC.C**

CRC calculation functions

**CE51X.C**

Functions to access the 12CE51x EEPROM

**CE62X.C**

Functions to access the 12CE62x EEPROM

**CE67X.C**

Functions to access the 12CE67x EEPROM

**CTYPE.H**

Definitions for various character handling functions

**DS1302.C**

Real time clock functions

**DS1621.C**

Temperature functions

**DS1621M.C**

Temperature functions for multiple DS1621 devices on the same bus

**DS1631.C**

Temperature functions

**DS1624.C**

Temperature functions

**DS1868.C**

Digital POT functions

**ERRNO.H**

Standard C error handling for math errors

**FLOAT.H**

Standard C float constants

**FLOATEE.C**

Functions to read/write floats to an EEPROM

**INPUT.C**

Functions to read strings and numbers via RS232

**ISD4003.C**

Functions for the ISD4003 voice record/playback chip

TEST PCD

**KBD.C**

Functions to read a keypad

**LCD.C**

LCD module functions

**LIMITS.H**

Standard C definitions for numeric limits

**LMX2326.C**

PLL functions

**LOADER.C**

A simple RS232 program loader

**LOCALE.H**

Standard C functions for local language support

**LTC1298.C**

12 Bit A/D converter functions

**MATH.H**

Various standard trig functions

**MAX517.C**

D/A converter functions

**MCP3208.C**

A/D converter functions

**NJU6355.C**

Real time clock functions

**PCF8570.C**

Serial RAM functions

**SC28L19X.C**

Driver for the Phillips external UART (4 or 8 port)

**SETJMP.H**

Standard C functions for doing jumps outside functions

**STDDEF.H**

Standard C definitions

**STDIO.H**

Not much here - Provided for standard C compatibility

**STDLIB.H**

String to number functions

**STDLIBM.H**

Standard C memory management functions

**STRING.H**

Various standard string functions

**TONES.C**

Functions to generate tones

**TOUCH.C**

Functions to read/write to Dallas touch devices

**USB.H**

Standard USB request and token handler code

**USB960X.C**

Functions to interface to National's USB960x USB chips

**USB.C**

USB token and request handler code, Also includes usb\_desc.h and usb.h

**X10.C**

Functions to read/write X10 codes





# SOFTWARE LICENSE AGREEMENT



C Compiler

## SOFTWARE LICENSE AGREEMENT

By opening the software diskette package, you agree to abide by the following provisions. If you choose not to agree with these provisions promptly return the unopened package for a refund.

1. License- Custom Computer Services ("CCS") grants you a license to use the software program ("Licensed Materials") on a single-user computer. Use of the Licensed Materials on a network requires payment of additional fees.
2. Applications Software- Derivative programs you create using the Licensed Materials identified as Applications Software, are not subject to this agreement.
3. Warranty- CCS warrants the media to be free from defects in material and workmanship and that the software will substantially conform to the related documentation for a period of thirty (30) days after the date of your purchase. CCS does not warrant that the Licensed Materials will be free from error or will meet your specific requirements.
4. Limitations- CCS makes no warranty or condition, either expressed or implied, including but not limited to any implied warranties of merchantability and fitness for a particular purpose, regarding the Licensed Materials.

Neither CCS nor any applicable licensor will be liable for an incidental or consequential damages, including but not limited to lost profits.

5. Transfers- Licensee agrees not to transfer or export the Licensed Materials to any country other than it was originally shipped to by CCS.

The Licensed Materials are copyrighted  
© 1994-2010 Custom Computer Services Incorporated  
All Rights Reserved Worldwide  
P.O. Box 2452  
Brookfield, WI 53008



# INDEX

|                       |    |                   |     |
|-----------------------|----|-------------------|-----|
| #                     |    | #INT_C2RX.....    | 98  |
| #ASM.....             | 73 | #INT_C2TX.....    | 98  |
| #BANK_DMA.....        | 82 | #INT_CAN1.....    | 98  |
| #BANKX.....           | 83 | #INT_CAN1E.....   | 98  |
| #BANKY.....           | 83 | #INT_CAN1RX.....  | 98  |
| #BIT.....             | 84 | #INT_CAN1TX.....  | 98  |
| #BUILD.....           | 84 | #INT_CAN2.....    | 98  |
| #BYTE.....            | 85 | #INT_CAN2E.....   | 98  |
| #CASE.....            | 86 | #INT_CAN2RX.....  | 98  |
| #DEFINE.....          | 87 | #INT_CAN2TX.....  | 98  |
| #DEFINEDINC.....      | 87 | #INT_CNI.....     | 98  |
| #DEVICE.....          | 88 | #INT_CRC.....     | 98  |
| #ELIF.....            | 95 | #INT_DCI.....     | 98  |
| #ELSE.....            | 95 | #INT_DCIE.....    | 98  |
| #ENDIF.....           | 95 | #INT_DEFAULT..... | 101 |
| #ERROR.....           | 90 | #INT_DMA0.....    | 98  |
| #EXPORT.....          | 91 | #INT_DMA1.....    | 98  |
| #FILL_ROM.....        | 92 | #INT_DMA2.....    | 98  |
| #FUSES.....           | 93 | #INT_DMA3.....    | 98  |
| #HEXCOMMENT.....      | 94 | #INT_DMA4.....    | 98  |
| #ID.....              | 94 | #INT_DMA5.....    | 98  |
| #IF.....              | 95 | #INT_DMA6.....    | 98  |
| #IF expr.....         | 95 | #INT_DMA7.....    | 98  |
| #IFDEF.....           | 95 | #INT_DMAERR.....  | 98  |
| #IFNDEF.....          | 95 | #INT_EXT1.....    | 98  |
| #IGNORE_WARNINGS..... | 96 | #INT_EXT2.....    | 98  |
| #IMPORT.....          | 96 | #INT_EXT3.....    | 98  |
| #INCLUDE.....         | 97 | #INT_EXT4.....    | 98  |
| #INLINE.....          | 98 | #INT_FAULTA.....  | 98  |
| #INT_AC1.....         | 98 | #INT_FAULTA2..... | 98  |
| #INT_AC2.....         | 98 | #INT_FAULTB.....  | 98  |
| #INT_AC3.....         | 98 | #INT_IC1.....     | 98  |
| #INT_AC4.....         | 98 | #INT_IC2.....     | 98  |
| #INT_AD2.....         | 98 | #INT_IC3.....     | 98  |
| #INT_ADC1.....        | 98 | #INT_IC4.....     | 98  |
| #INT_ADC2.....        | 98 | #INT_IC5.....     | 98  |
| #INT_ADCP0.....       | 98 | #INT_IC6.....     | 98  |
| #INT_ADCP1.....       | 98 | #INT_IC7.....     | 98  |
| #INT_ADCP2.....       | 98 | #INT_IC8.....     | 98  |
| #INT_ADCP3.....       | 98 | #INT_LOWVOLT..... | 98  |
| #INT_ADCP4.....       | 98 | #INT_LVD.....     | 98  |
| #INT_ADCP5.....       | 98 | #INT_MATHERR..... | 98  |
| #INT_ADDRERR.....     | 98 | #INT_MI2C.....    | 98  |
| #INT_C1RX.....        | 98 | #INT_MI2C1.....   | 98  |
| #INT_C1TX.....        | 98 | #INT_MI2C2.....   | 98  |

TEST PCD

|                    |     |                          |     |
|--------------------|-----|--------------------------|-----|
| #INT_NVM.....      | 98  | #NOLIST.....             | 104 |
| #INT_OC1.....      | 98  | #OCS.....                | 105 |
| #INT_OC2.....      | 98  | #OPT.....                | 105 |
| #INT_OC3.....      | 98  | #ORG.....                | 105 |
| #INT_OC4.....      | 98  | #PRAGMA.....             | 107 |
| #INT_OC5.....      | 98  | #RECURSIVE.....          | 107 |
| #INT_OC6.....      | 98  | #RESERVE.....            | 108 |
| #INT_OC7.....      | 98  | #ROM.....                | 108 |
| #INT_OC8.....      | 98  | #SEPARATE.....           | 109 |
| #INT_OSC_FAIL..... | 98  | #SERIALIZE.....          | 110 |
| #INT_PMP.....      | 98  | #TASK.....               | 111 |
| #INT_PWM.....      | 98  | #TYPE.....               | 112 |
| #INT_PWM1.....     | 98  | #UNDEF.....              | 113 |
| #INT_PWM2.....     | 98  | #USE DELAY.....          | 114 |
| #INT_PWM3.....     | 98  | #USE DYNAMIC_MEMORY..... | 114 |
| #INT_PWM4.....     | 98  | #USE FAST_IO.....        | 114 |
| #INT_PWMP.....     | 98  | #USE FIXED_IO.....       | 115 |
| #INT_PWMP2.....    | 98  | #USE I2C.....            | 115 |
| #INT_PWMSEM.....   | 98  | #USE RS232.....          | 116 |
| #INT_QEI.....      | 98  | #USE RTOS.....           | 119 |
| #INT_RDA.....      | 98  | #USE SPI.....            | 120 |
| #INT_RDA2.....     | 98  | #USE STANDARD_IO.....    | 121 |
| #INT_RTC.....      | 98  | #USE TIMER.....          | 122 |
| #INT_SI2C.....     | 98  | #USE TOUCHPAD.....       | 123 |
| #INT_SI2C1.....    | 98  | #WARNING.....            | 123 |
| #INT_SI2C2.....    | 98  | #WORD.....               | 124 |
| #INT_SPI1.....     | 98  | #ZERO_RAM.....           | 124 |
| #INT_SPI1E.....    | 98  | .                        |     |
| #INT_SPI2.....     | 98  | .LST file.....           | 301 |
| #INT_SPI2E.....    | 98  | ;                        |     |
| #INT_SPIE.....     | 98  | ;                        | 27  |
| #INT_STACKERR..... | 98  | -                        |     |
| #INT_TBE.....      | 98  | __ DATE__.....           | 86  |
| #INT_TBE2.....     | 98  | __ TIME__.....           | 111 |
| #INT_TIMER1.....   | 98  | __ ADDRESS__.....        | 35  |
| #INT_TIMER2.....   | 98  | __ DATE__.....           | 86  |
| #INT_TIMER3.....   | 98  | __ DEVICE__.....         | 90  |
| #INT_TIMER4.....   | 98  | __ FILE__.....           | 92  |
| #INT_TIMER5.....   | 98  | __ FILENAME__.....       | 92  |
| #INT_TIMER6.....   | 98  | __ LINE__.....           | 102 |
| #INT_TIMER7.....   | 98  | __ PCD__.....            | 106 |
| #INT_TIMER8.....   | 98  | __ TIME__.....           | 111 |
| #INT_TIMER9.....   | 98  | __ fixed.....            | 35  |
| #INT_UART1E.....   | 98  | __ LOCATE.....           | 103 |
| #INT_UART2E.....   | 98  | <b>A</b>                 |     |
| #INT_xxx.....      | 98  | abs.....                 | 130 |
| #LIST.....         | 102 | adc.....                 | 44  |
| #LOCATE.....       | 103 | adc_done.....            | 131 |
| #MODULE.....       | 104 | Addressmod.....          | 38  |

|                            |     |
|----------------------------|-----|
| Analog_Comparator.....     | 45  |
| ASM.....                   | 73  |
| assert.....                | 131 |
| atof.....                  | 132 |
| atoi.....                  | 132 |
| atoi32.....                | 133 |
| atoi48.....                | 133 |
| atoi64.....                | 133 |
| atol.....                  | 133 |
| auto.....                  | 35  |
| <b>B</b>                   |     |
| BANK_DMA.....              | 82  |
| BANKX.....                 | 83  |
| BANKY.....                 | 83  |
| Basic_types.....           | 35  |
| #char.....                 | 35  |
| #double.....               | 35  |
| #float.....                | 35  |
| #Int.....                  | 35  |
| #int1.....                 | 35  |
| #int16.....                | 35  |
| #int32.....                | 35  |
| #int8.....                 | 35  |
| #long.....                 | 35  |
| #short.....                | 35  |
| _fixed(n).....             | 35  |
| Auto.....                  | 35  |
| const.....                 | 35  |
| double.....                | 35  |
| extern.....                | 35  |
| register.....              | 35  |
| signed.....                | 35  |
| static.....                | 35  |
| unsigned.....              | 35  |
| void.....                  | 35  |
| volatile.....              | 35  |
| BIFPCD.....                | 127 |
| BIT.....                   | 84  |
| bit_clear.....             | 134 |
| bit_first.....             | 134 |
| bit_last.....              | 135 |
| bit_set.....               | 135 |
| bit_test.....              | 136 |
| break.....                 | 27  |
| bsearch.....               | 137 |
| BUILD.....                 | 84  |
| BYTE.....                  | 85  |
| <b>C</b>                   |     |
| Calling_the_compiler.....  | 9   |
| calloc.....                | 137 |
| CAN_Bus.....               | 45  |
| CASE.....                  | 25  |
| ceil.....                  | 138 |
| char.....                  | 35  |
| char_bit.....              | 270 |
| clear_interrupt.....       | 138 |
| Command_Line_Compiler..... | 9   |
| Comment.....               | 11  |
| const.....                 | 35  |
| constant_data_table.....   | 286 |
| Continue.....              | 27  |
| conversions.....           | 285 |
| cos.....                   | 247 |
| cosh.....                  | 247 |
| CRC.....                   | 49  |
| crc_calc.....              | 139 |
| crc_init.....              | 140 |
| <b>D</b>                   |     |
| DAC.....                   | 50  |
| dac_write.....             | 140 |
| Data_EEPROM.....           | 50  |
| data_table.....            | 286 |
| Data_Types.....            | 35  |
| DATE.....                  | 86  |
| DCI.....                   | 51  |
| dci_data_received.....     | 141 |
| dci_read.....              | 142 |
| dci_start.....             | 142 |
| dci_transmit_ready.....    | 143 |
| dci_write.....             | 144 |
| default.....               | 25  |
| Default_Parameters.....    | 32  |
| DEFINE.....                | 87  |
| DEFINEDINC.....            | 87  |
| DELAY.....                 | 114 |
| delay_cycles.....          | 144 |
| delay_ms.....              | 145 |
| delay_us.....              | 145 |
| DEVICE.....                | 88  |
| Directories.....           | 8   |
| disable_interrupts.....    | 146 |
| div.....                   | 147 |
| DMA.....                   | 52  |
| dma_start.....             | 148 |
| dma_status.....            | 149 |
| do.....                    | 24  |
|                            | 345 |

TEST PCD

|                            |     |  |     |
|----------------------------|-----|--|-----|
| double .....               | 35  | get_timer .....  | 157 |
| <b>E</b>                   |     | get_timer1 .....   | 157 |
| ELIF .....                 | 95  | get_timer2 .....   | 157 |
| ELSE .....                 | 23  | get_timer23 .....  | 157 |
| enable_interrupts .....    | 149 | get_timer3 .....   | 157 |
| ENDIF .....                | 95  | get_timer4 .....   | 157 |
| enum .....                 | 35  | get_timer45 .....  | 157 |
| erase_program_memory ..... | 150 | get_timer5 .....   | 157 |
| errno.h .....              | 269 | get_timer6 .....   | 157 |
| ERROR .....                | 90  | get_timer67 .....  | 157 |
| ex_str.c .....             | 261 | get_timer7 .....   | 157 |
| Example_Programs .....     | 305 | get_timer8 .....   | 157 |
| exp .....                  | 151 | get_timer89 .....  | 157 |
| EXPORT .....               | 91  | get_timer9 .....   | 157 |
| expr .....                 | 27  | get_timerx .....   | 157 |
| Expressions .....          | 29  | get_timerxy .....  | 157 |
| ext_int_edge .....         | 151 | get_tris_a .....   | 158 |
| Extended RAM .....         | 54  | get_tris_b .....   | 158 |
| extern .....               | 35  | get_tris_c .....   | 158 |
| <b>F</b>                   |     | get_tris_d .....   | 158 |
| fabs .....                 | 152 | get_tris_e .....   | 158 |
| FAST_IO .....              | 114 | get_tris_f .....   | 158 |
| fgetc .....                | 158 | get_tris_g .....   | 158 |
| fgets .....                | 162 | get_tris_h .....   | 158 |
| FILE .....                 | 92  | get_tris_j .....   | 158 |
| File_Formats .....         | 8   | get_tris_k .....   | 158 |
| FILENAME .....             | 92  | get_tris_x .....   | 158 |
| FILL_ROM .....             | 92  | getc .....   | 158 |
| FIXED_IO .....             | 115 | getc_timeout .....   | 288 |
| float .....                | 35  | getch .....  | 158 |
| float.h .....              | 269 | getenv .....   | 159 |
| float32 .....              | 35  | gets .....   | 162 |
| float48 .....              | 35  | goto .....   | 26  |
| float64 .....              | 35  | goto_address .....   | 162 |
| floor .....                | 152 | <b>H</b>   |     |
| fmod .....                 | 153 | HEXCOMMENT .....   | 94  |
| for .....                  | 25  | high_speed_adc_done .....  | 163 |
| fprintf .....              | 193 | How do I wait only a specified time for a<br>button press? ..... | 289 |
| fputc .....                | 196 | How_are_type_conversions_handled? .....                          | 285 |
| fputs .....                | 197 | How_can_a_constant_data_table_be_place<br>d_in_ROM? .....        | 286 |
| free .....                 | 153 | How_can_I_use_two_or_more_RS-<br>232_ports_on_one_PIC? .....     | 287 |
| frexp .....                | 154 | How_do_I_directly_read/write_to_internal_re<br>gisters? .....    | 287 |
| Function_Definition .....  | 40  | How_do_I_do_a_printf_to_a_string? .....                          | 288 |
| FUSES .....                | 93  | How_do_I_get_getc_to_timeout_after_a_spe<br>cified_time? .....   | 288 |
| <b>G</b>                   |     |  |     |
| get_capturex .....         | 154 |  |     |
| get_motor_pwm_count .....  | 155 |  |     |
| get_rtcc .....             | 157 |  |     |
| get_ticks .....            | 155 |  |     |

|   |     |  |     |
|---|-----|--|-----|
| How_does_one_map_a_variable_to_an_I/O_port? ..... | 290 | int8 .....                               | 35  |
| How_does_the_PIC_connect_to_a_PC? .....           | 292 | Internal_Oscillator .....                | 56  |
| How_does_the_PIC_connect_to_an_I2C_device? .....  | 293 | internal_registers .....                 | 287 |
| How_much_time_do_math_operations_take? .....      | 293 | interrupt_active .....                   | 171 |
| <b>I</b>  |     | interrupts .....                         | 57  |
| I/O_Port .....                                    | 290 | Invoking_the_Command_Line_Compiler ..... | 9   |
| I2C .....   | 43  | isalnum .....                            | 172 |
| i2c_isr_state .....                               | 164 | isalnum_char .....                       | 172 |
| i2c_poll .....                                    | 165 | isamong .....                            | 173 |
| i2c_read .....                                    | 165 | iscntrl .....                            | 172 |
| i2c_slaveaddr .....                               | 166 | isdigit .....                            | 172 |
| i2c_start .....                                   | 167 | isgraph .....                            | 172 |
| i2c_stop .....                                    | 168 | islower .....                            | 172 |
| i2c_write .....                                   | 168 | isprint .....                            | 172 |
| ID .....  | 94  | ispunct .....                            | 172 |
| IF23  |     | isspace .....                            | 172 |
| IFDEF .....                                       | 95  | isupper .....                            | 172 |
| IFDEF .....                                       | 95  | isxdigit .....                           | 172 |
| IGNORE_WARNINGS .....                             | 96  | itoa .....                               | 173 |
| IMPORT .....                                      | 96  | <b>K</b>                                 |     |
| INCLUDE .....                                     | 97  | kbhit .....                              | 174 |
| INLINE .....                                      | 98  | <b>L</b>                                 |     |
| input .....                                       | 169 | label_address .....                      | 175 |
| input_a .....                                     | 171 | labs .....                               | 175 |
| input_b .....                                     | 171 | ldexp .....                              | 176 |
| input_c .....                                     | 171 | ldiv .....                               | 147 |
| Input_Capture .....                               | 55  | License_Agreement .....                  | 315 |
| input_change_x .....                              | 169 | limits.h .....                           | 270 |
| input_d .....                                     | 171 | LINE .....                               | 102 |
| input_e .....                                     | 171 | LIST .....                               | 102 |
| input_f .....                                     | 171 | locale.h .....                           | 270 |
| input_g .....                                     | 171 | LOCATE .....                             | 103 |
| input_h .....                                     | 171 | log .....                                | 176 |
| input_j .....                                     | 171 | log10 .....                              | 177 |
| input_k .....                                     | 171 | long long .....                          | 35  |
| input_state .....                                 | 170 | long_max .....                           | 270 |
| input_x .....                                     | 171 | long_min .....                           | 270 |
| INT .....   | 35  | longjmp .....                            | 177 |
| INT_DEFAULT .....                                 | 101 | longjmp_ .....                           | 177 |
| int_max .....                                     | 270 | <b>M</b>                                 |     |
| int_min .....                                     | 270 | make16 .....                             | 178 |
| int1 .....  | 35  | make32 .....                             | 179 |
| int16 .....                                       | 35  | make8 .....                              | 178 |
| int32 .....                                       | 35  | malloc .....                             | 180 |
| int48 .....                                       | 35  | math_operations .....                    | 293 |
| int64 .....                                       | 35  | mb_len_max .....                         | 270 |
|   |     | memchr .....                             | 253 |
|   |     | memcmp .....                             | 253 |
|   |     | memcpy .....                             | 180 |

TEST PCD

|                        |     |                           |     |
|------------------------|-----|---------------------------|-----|
| memcpy                 | 180 | pmp_read                  | 190 |
| memset                 | 181 | pmp_write                 | 191 |
| modf                   | 181 | port_x_pullups            | 192 |
| MODULE                 | 104 | pow                       | 193 |
| Motor Control PWM      | 58  | PRAGMA                    | 107 |
| mul                    | 182 | printf                    | 193 |
| Multiple_Project_Files | 12  | psp_input_full            | 195 |
| multiple_RS-232_ports  | 287 | psp_output_full           | 195 |
| <b>N</b>               |     | psp_overflow              | 195 |
| nargs                  | 182 | psp_read                  | 195 |
| NOLIST                 | 104 | psp_write                 | 196 |
| null                   | 271 | ptrdiff_t                 | 271 |
| <b>O</b>               |     | putc                      | 196 |
| offsetof               | 183 | putchar                   | 196 |
| offsetof_              | 183 | puts                      | 197 |
| offsetofbit            | 183 | <b>Q</b>                  |     |
| Operator_Precedence    | 30  | QEI                       | 62  |
| Operators              | 29  | qe_get_count              | 198 |
| OPT                    | 105 | qe_set_count              | 198 |
| ORG                    | 105 | qe_status                 | 198 |
| output_a               | 184 | qsort                     | 199 |
| output_b               | 184 | <b>R</b>                  |     |
| output_bit             | 185 | rand                      | 200 |
| output_c               | 184 | read/write                | 287 |
| Output_Compare         | 58  | read_adc                  | 200 |
| output_d               | 184 | read_adc2                 | 200 |
| output_drive           | 185 | read_configuration_memory | 201 |
| output_e               | 184 | read_eeprom               | 201 |
| output_f               | 184 | read_extended_ram         | 202 |
| output_float           | 186 | read_high_speed_adc       | 203 |
| output_g               | 184 | read_program_memory       | 204 |
| output_h               | 184 | read_rom_memory           | 205 |
| output_high            | 187 | realloc                   | 205 |
| output_i               | 184 | RECURSIVE                 | 107 |
| output_j               | 184 | Reference_Parameters      | 31  |
| output_k               | 184 | register                  | 35  |
| output_low             | 187 | RESERVE                   | 108 |
| output_toggle          | 188 | reset_cpu                 | 206 |
| output_x               | 184 | restart_cause             | 207 |
| Overloaded_Functions   | 32  | restart_wdt               | 207 |
| <b>P</b>               |     | Return                    | 26  |
| PCD_Overview           | 1   | ROM                       | 108 |
| perror                 | 188 | rotate_left               | 208 |
| PIC_to_I2C             | 293 | rotate_right              | 208 |
| PIC_to_PC              | 292 | RS232                     | 116 |
| pmp_address            | 189 | RS-232                    | 302 |
| pmp_input_full         | 189 | rtc_alarm_read            | 209 |
| pmp_output_full        | 189 | rtc_alarm_write           | 210 |
| pmp_overflow           | 189 | rtc_read                  | 210 |



|                          |     |                                |     |
|--------------------------|-----|--------------------------------|-----|
| rtc_write .....          | 211 | setjmp.h .....                 | 271 |
| RTCC .....               | 64  | setjmp_ .....                  | 225 |
| RTOS .....               | 119 | setup_adc .....                | 226 |
| rtos_await .....         | 211 | setup_adc_mode.....            | 226 |
| rtos_disable .....       | 212 | setup_adc_ports.....           | 227 |
| rtos_enable .....        | 212 | setup_adc_ports2.....          | 227 |
| rtos_msg_poll .....      | 213 | setup_adc2 .....               | 226 |
| rtos_msg_read.....       | 213 | setup_adc2mode.....            | 226 |
| rtos_msg_send .....      | 214 | setup_capture .....            | 228 |
| rtos_overrun.....        | 214 | setup_comparator .....         | 228 |
| rtos_run.....            | 215 | setup_compare .....            | 229 |
| rtos_signal .....        | 215 | setup_crc .....                | 230 |
| rtos_stats .....         | 216 | setup_dac .....                | 230 |
| rtos_terminate.....      | 216 | setup_dci.....                 | 231 |
| rtos_wait .....          | 217 | setup_dma .....                | 232 |
| rtos_yield .....         | 217 | setup_high_speed_adc.....      | 233 |
| <b>S</b>                 |     | setup_high_speed_adc_pair..... | 233 |
| schar_max .....          | 270 | setup_low_volt_detect.....     | 234 |
| schar_min .....          | 270 | setup_motor_pwm.....           | 235 |
| Semi_Colon .....         | 27  | setup_motor_unit .....         | 220 |
| SEPARATE.....            | 109 | setup_oscillator .....         | 235 |
| SERIALIZE .....          | 110 | setup_pmp .....                | 236 |
| set_adc_channel.....     | 218 | setup_psp .....                | 237 |
| set_adc_channel2.....    | 218 | setup_qei .....                | 238 |
| set_compare_time .....   | 219 | setup_rtc .....                | 239 |
| set_motor_pwm_duty.....  | 219 | setup_rtc_alarm .....          | 240 |
| set_motor_pwm_event..... | 220 | setup_spi.....                 | 240 |
| set_motor_unit.....      | 220 | setup_timer .....              | 241 |
| set_pullup .....         | 221 | setup_timer1 .....             | 241 |
| set_ticks .....          | 221 | setup_timer2 .....             | 241 |
| set_timer23 .....        | 223 | setup_timer3 .....             | 241 |
| set_timer45 .....        | 223 | setup_timer4 .....             | 241 |
| set_timer67 .....        | 223 | setup_timer5 .....             | 241 |
| set_timer89 .....        | 223 | setup_timer6 .....             | 241 |
| set_timerx .....         | 223 | setup_timer7 .....             | 241 |
| set_timerxy .....        | 223 | setup_timer8 .....             | 241 |
| set_tris_a .....         | 224 | setup_timer9 .....             | 241 |
| set_tris_b .....         | 224 | setup_uart .....               | 243 |
| set_tris_c .....         | 224 | setup_vref .....               | 244 |
| set_tris_d .....         | 224 | setup_wdt.....                 | 245 |
| set_tris_e .....         | 224 | shift_left.....                | 245 |
| set_tris_f .....         | 224 | shift_right .....              | 246 |
| set_tris_g .....         | 224 | short.....                     | 35  |
| set_tris_h .....         | 224 | shrt_max .....                 | 270 |
| set_tris_i .....         | 224 | shrt_min .....                 | 270 |
| set_tris_k .....         | 224 | signed .....                   | 35  |
| set_tris_x .....         | 224 | sin .....                      | 247 |
| set_uart_speed.....      | 225 | sinh .....                     | 247 |
| setjmp .....             | 271 | size_t.....                    | 271 |

TEST PCD

|                                 |     |   |     |
|---------------------------------|-----|---|-----|
| sizeof .....                    | 29  | timer .....   | 157 |
| sleep .....                     | 248 | tolower .....   | 261 |
| spi_data_is_in .....            | 249 | touchpad_getc .....   | 262 |
| spi_data_is_in2 .....           | 249 | touchpad_hit .....  | 262 |
| spi_read .....                  | 249 | touchpad_state .....  | 263 |
| spi_read2 .....                 | 249 | toupper .....   | 261 |
| spi_write .....                 | 250 | Trigraph_Sequences .....  | 12  |
| spi_write2 .....                | 250 | TYPE .....  | 112 |
| spi_xfer .....                  | 250 | type_conversions .....  | 285 |
| sprintf .....                   | 251 | typedef .....   | 35  |
| sqrt .....                      | 252 | typemod .....   | 38  |
| srand .....                     | 252 | <b>U</b>  |     |
| STANDARD_IO .....               | 121 | uchar_max .....   | 270 |
| standard_string_functions ..... | 253 | uchar_min .....   | 270 |
| Statements .....                | 23  | uint_max .....  | 270 |
| static .....                    | 35  | ulong_max .....   | 270 |
| stddef.h .....                  | 271 | UNDEF .....   | 113 |
| stdio.h .....                   | 271 | union .....   | 35  |
| stdlib.h .....                  | 271 | unsigned .....  | 35  |
| stmt .....                      | 28  | USE_RS232 .....   | 116 |
| strbrk .....                    | 257 | USE_RTOS .....  | 119 |
| strcat .....                    | 255 | USE_DYNAMIC_MEMORY .....  | 114 |
| strchr .....                    | 255 | USE_SPI .....   | 120 |
| strcmp .....                    | 255 | USE_DELAY .....   | 114 |
| strcoll .....                   | 255 | USE_FAST_IO .....   | 114 |
| strcpy .....                    | 256 | USE_FIXED_IO .....  | 115 |
| strncpy .....                   | 256 | USE_I2C .....   | 115 |
| strcspn .....                   | 256 | USE_STANDARD_IO .....   | 121 |
| string .....                    | 288 | USE_TOUCHPAD .....  | 123 |
| strlen .....                    | 256 | ushrt_max .....   | 270 |
| strlwr .....                    | 256 | <b>V</b>  |     |
| strncat .....                   | 257 | va_arg .....  | 264 |
| strncmp .....                   | 257 | va_end .....  | 264 |
| strncpy .....                   | 257 | va_start .....  | 265 |
| strrchr .....                   | 257 | Variable_Parameters .....   | 31  |
| strspn .....                    | 257 | void .....  | 35  |
| strstr .....                    | 257 | volatile .....  | 35  |
| strtod .....                    | 257 | <b>W</b>  |     |
| strtok .....                    | 258 | WARNING .....   | 123 |
| strtol .....                    | 259 | Watch_Dog_Timer .....   | 71  |
| strtoul .....                   | 260 | wchar_t .....   | 271 |
| strxfrm .....                   | 260 | WDT .....   | 71  |
| swap .....                      | 260 | WDT_or_Watch_Dog_Timer .....  | 71  |
| switch .....                    | 25  | What are the various Fuse options for the<br>dsPIC/PIC 24 chips ..... | 295 |
| <b>T</b>                        |     | What_can_be_done_about_an_OUT_OF_R<br>AM_error? .....                 | 297 |
| tan .....                       | 247 | while .....   | 24  |
| tanh .....                      | 247 |   |     |
| TASK .....                      | 111 |   |     |
| Technical_Support .....         | 7   |   |     |

|   |     |                            |     |
|---|-----|----------------------------|-----|
| Why_does_the_.LST_file_look_out_of_order<br>? ..... | 301 | write_extended_ram.....    | 267 |
| Why_is_the_RS-232_not_working_right?                | 302 | write_program_memory ..... | 268 |
| WORD .....  | 124 | <b>Z</b>                   |     |
| write_configuration_memory.....                     | 266 | ZERO_RAM .....             | 124 |
| write_eeprom .....                                  | 266 |                            |     |

